

[Review responses online](#) ↗

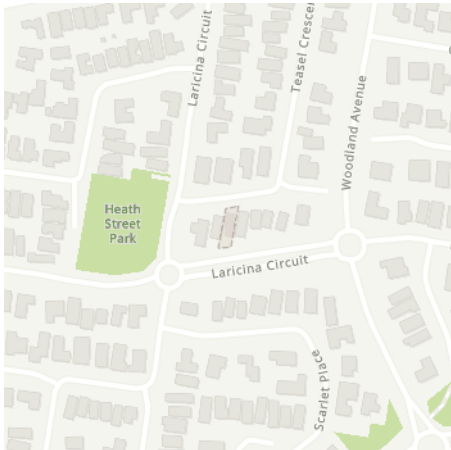

Received 6 of 6 responses  
**All responses received**

5 Teasel Cr, Forest Lake QLD 4078

Job dates  
 08/01/2025 → 04/04/2025

These plans expire on  
 14 Jan 2025

Lodged by  
 Abigail Mercado

Authority	Status	Page
✉ BYDA Confirmation		2
🏠 APA Group Gas Networks (90073)	Received	4
🏠 Brisbane City Council	Received	56
🏠 Energex QLD	Received	59
🏠 NBN Co Qld	Received	97
🏠 Queensland Urban Utilities	Received	111
🏠 Telstra QLD FA	Received	116

## Contact Details

<b>Contact</b> Abigail Mercado	<b>Contact number</b> 0419 713 388	<b>Company</b> ilookproperty	<b>Enquirer ID</b> 3581815
<b>Email</b> property1@ilookproperty.com.au		<b>Address</b> P O Box 221 Buddina QLD 4575	

## Job Site and Enquiry Details

**WARNING:** The map below only displays the location of the proposed job site and does not display any asset owners' pipe or cables. The area highlighted has been used only to identify the participating asset owners, who will send information to you directly.

<b>Enquiry date</b> 17/12/2024	<b>Start date</b> 08/01/2025	<b>End date</b> 04/04/2025	<b>On behalf of</b> Private	<b>Job purpose</b> Excavation	<b>Locations</b> Both Road, Nature Strip, Footpath	<b>Onsite activities</b> Blasting, Horizontal Boring, Manual Excavation, Mechanical Excavation, Non- Destructive Digging, Subdivision, Vertical Boring
-----------------------------------	---------------------------------	-------------------------------	--------------------------------	----------------------------------	--	--

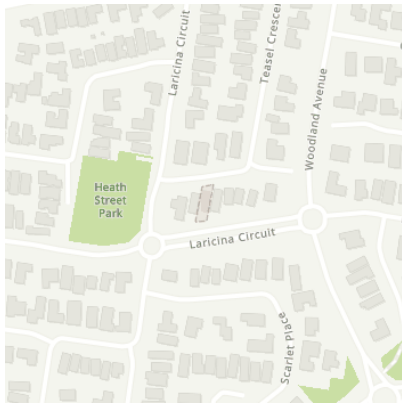

Check that the location of the job site is correct. If not, you must submit a new enquiry.

If the scope of works change or plan validity dates expire, you must submit a new enquiry.

Do NOT dig without plans. Safe excavation is your responsibility. If you don't understand the plans or how to proceed safely, please contact the relevant asset owners.

<b>User Reference</b> 5 Teasel Cr	<b>Address</b> 5 Teasel Cr Forest Lake QLD 4078	<b>Notes/description</b> -
--------------------------------------	---	-------------------------------

## Your Responsibility and Duty of Care

- **Lodging an enquiry does not authorise project commencement.** Before starting work, you must obtain all necessary information from all affected asset owners.
- If you don't receive plans within 2 business days, contact the asset owner & quote their sequence number.
- Always follow the 5Ps of Safe Excavation (page 2), and locate assets before commencing work.
- Ensure you comply with State legislative requirements for Duty of Care and safe digging.
- If you damage an underground asset, you MUST advise the asset owner immediately.
- By using the BYDA service, you agree to the [Privacy Policy](#) and [Term of Use](#).
- For more information on safe digging practices, visit [www.byda.com.au](http://www.byda.com.au)

## Asset Owner Details

Below is a list of asset owners with underground infrastructure in and around your job site. It is your responsibility to identify the presence of these assets. Plans issued by Members are indicative only unless specified otherwise. Note: not all asset owners are registered with BYDA. You must contact asset owners not listed here directly.

Referral ID (Seq. no)	Authority Name	Phone	Status
248885697	APA Group Gas Networks (90073)	1800 085 628	NOTIFIED
248885698	Brisbane City Council	(07) 3403 8888	NOTIFIED
248885699	Energex QLD	13 12 53	NOTIFIED
248885696	NBN Co Qld	1800 687 626	NOTIFIED
248885701	Queensland Urban Utilities	13 26 57	NOTIFIED
248885700	Telstra QLD FA	1800 653 935	NOTIFIED

END OF UTILITIES LIST



## Plan

Plan your job. Use the BYDA service at least one day before your job is due to begin, and ensure you have the correct plans and information required to carry out a safe project.



## Prepare

Prepare by communicating with asset owners if you need assistance. Look for clues onsite. Engage a skilled Locator.



## Pothole

Potholing is physically sighting the asset by hand digging or hydro vacuum extraction.

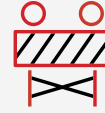

## Protect

Protecting and supporting the exposed infrastructure is the responsibility of the excavator. Always erect safety barriers in areas of risk and enforce exclusion zones.



## Proceed

Only proceed with your excavation work after planning, preparing, potholing (unless prohibited), and having protective measures in place.

## Engage a skilled Locator

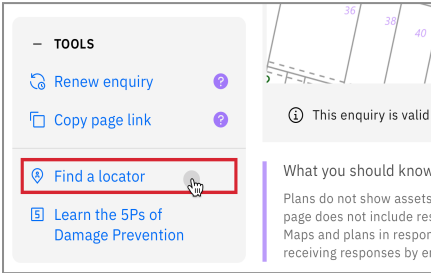

When you lodge an enquiry you will see skilled Locators to contact

Visit the Certified Locator website directly and search for a locator near you

[certloc.com.au/locators](http://certloc.com.au/locators)

## Book a FREE BYDA Session



BYDA offers two different sessions to suit you and your organisation's needs. The free sessions are offered in two different formats - online and face-to-face:

1. **Awareness Session:** Understand the role of BYDA, safe excavation practices, complying with asset-owner instructions, and the consequences of damages. Learn how to mitigate and avoid potential damage and harm and ensure a safe work environment.
2. **Plan Reading Session:** Develop the skills to interpret asset owners' plans, legends, and symbols effectively. Understand the complexities of plan interpretation to ensure smooth project execution.

To book a session, visit:

[byda.com.au/contact/education-awareness-enquiry-form/](http://byda.com.au/contact/education-awareness-enquiry-form/)

**BOOK NOW**

## APA Group Gas Networks (90073)

Referral  
248885697

Member Phone  
1800 085 628

### Responses from this member

Response received Tue 17 Dec 2024 12.43pm

File name	Page
Response Body	5
400-STD-AM-0001_2 Guidelines for Works Near Existing Gas Assets.pdf	6
248885697.pdf	47

**PLEASE NOTE:** This is an automated response. Please **DO NOT REPLY to this email**. If you require further information in relation to this Before You Dig response, please contact  
BYDA\_APA@apa.com.au

**Enquiry Details:**

Impact	affected
Sequence Number	248885697
Enquirer Id	3581815
Activity	Blasting,Horizontal Boring,Manual Excavation,Mechanical Excavation,Non- Destructive Digging,Subdivision,Vertical Boring
Job Number	38295369
User Reference	5 Teasel Cr
Message	

**Site Details:**

Address	5 Teasel Cr Forest Lake QLD 4078
---------	--

**Enquirers Details:**

Contact	Abigail Mercado
Company	ilookproperty
Email	property1@ilookproperty.com.au
Phone	+61419713388
Address	P O Box 221 Buddina QLD 4575

APA Group



# Guidelines for Works Near Existing Gas Assets

## 400-STD-AM-0001

Revision 2

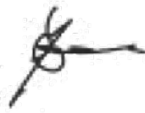
<b>OWNER NAME:</b>	Alan Creffield
<b>OWNER TITLE:</b>	Manager of Integrity
<b>APPROVER NAME:</b>	Anastasia Coutie
<b>APPROVER TITLE:</b>	Team Lead – 3 <sup>rd</sup> Party Engagement
<b>APPROVAL SIGNATURE:</b>	
<b>APPROVAL DATE:</b>	18/08/2023

always powering ahead

## DOCUMENT CONTROL & APPROVAL INFORMATION

### Summary of Changes

Below is a brief summary of the changes made to the document since the previous issued version.

Revision	Description	Date	Author
0.0	Issue for Use	29.06.2018	Matthew Read
1.0	Issued for Use – document periodic update / major overhaul	01.03.2022	Kahil Parsons
2.0	Removal of incorrect table 2 references to 1. proximity of HV cables 2. Updating separation distances to AS2885.3 BYDA reference update Table 4 Note	16.08.2023	Dale Russell

### Printed Working Copy

All printed copies of this document are to be used as reference copies only.

It is the responsibility of those with printed copies to ensure that the document is current.

### Responsibility

Any amendments to this document will be the responsibility of the document owner.

### Control

Controlled Networks documents including templates are published on the Networks National Document Library (NNDL).

All native copies of published controlled Networks documents are managed by [NetworksDocLibrary@apa.com.au](mailto:NetworksDocLibrary@apa.com.au) in accordance with 400-PR-QM-0001, Networks Controlled Documents Development and Review procedure.

## Table of Contents

DOCUMENT CONTROL & APPROVAL INFORMATION.....	2
Summary of Changes.....	2
Printed Working Copy.....	2
Responsibility.....	2
Control.....	2
TERMS OF USE.....	5
1 INTRODUCTION.....	6
<b>1.1</b> Scope of this Document.....	6
<b>1.2</b> Asset Types.....	6
1.2.1 Natural Gas Transmission.....	6
1.2.2 Natural Gas Distribution.....	7
1.2.3 LPG Distribution.....	7
<b>1.3</b> Damage and Emergencies.....	7
<b>1.4</b> General Duty of Care and Responsibility to Obtain Information.....	8
1.4.1 Additional Transmission Pressure Pipeline Requirements.....	8
2 PROTECTION PROCESS.....	9
<b>2.1</b> Assessment Information.....	9
3 PART 1 - APA NOTIFICATION AND AUTHORISATION REQUIREMENTS.....	11
<b>3.1</b> BYDA Request.....	11
<b>3.2</b> Provings and Site Identification.....	11
<b>3.3</b> APA Notification and Authorisation Process.....	11
<b>3.4</b> Commercial Agreement and Service Delivery.....	13
<b>3.5</b> Decommissioned Gas Assets.....	13
4 PART 2 - DESIGN AND ASSET PROTECTION REQUIREMENTS.....	15
<b>4.1</b> Standard Clearances.....	15
<b>4.2</b> Third Party Assets and Structures.....	19
<b>4.3</b> Landscaping Plans.....	19
<b>4.4</b> Surface Levels and Conditions.....	21
<b>4.5</b> Casings Vent Stacks.....	22
<b>4.6</b> Earthing and Electrical Effects.....	23
<b>4.7</b> Temporary and Permanent Vehicle Crossings.....	24
5 PART 3 - CONSTRUCTION AND LAND USE REQUIREMENTS.....	25
<b>5.1</b> Land Use Change.....	25
<b>5.2</b> Permits and Site Watch.....	25
<b>5.3</b> Coating Surveys and Leakage Surveys.....	26
<b>5.4</b> Pipeline Repairs, Recoating and Slabbing.....	26
<b>5.5</b> Exposure of Buried Gas Assets.....	27
5.5.1 General.....	27



5.5.2	Physically Proving Gas Assets .....	27
5.5.3	Hydro-Vacuum Excavation .....	28
5.5.4	Mechanical Excavation .....	29
5.5.6	Protection During Exposure .....	30
5.5.7	Backfill and Reinstatement .....	31
<b>5.6</b>	Trenchless Excavation .....	31
<b>5.7</b>	Piles, Piers or Poles .....	32
<b>5.8</b>	Hot Works for Construction Activities .....	32
<b>5.9</b>	Vibration Limits .....	32
<b>5.10</b>	Compaction Limits .....	33
<b>5.11</b>	Blasting / Seismic Survey / Explosives .....	33
<b>5.12</b>	Suspended Materials above Gas Assets and No Go Zones for Cranes .....	34
<b>5.13</b>	Temporary Materials .....	34
6	PART 4 - ALTERATION OF EXISTING GAS ASSETS .....	34
7	GLOSSARY OF TERMS AND ABBREVIATIONS .....	35
8	DOCUMENT REFERENCES .....	40
	<b>APPENDIX A GENERAL BYDA RESPONSE PROCESS .....</b>	<b>41</b>

## TERMS OF USE

The “Guidelines for Works Near Existing Gas Assets Standard” is used for APA Networks excavations or third party excavations near APA Network operated assets. This guideline must only be used by the person or entity who received it directly from APA (“You”) to ensure the latest version is used.

APA Networks has provided this document to You subject to the terms of use set out below. By retaining possession of this document, You acknowledge and agree to the following conditions;

1. The information contained in this document relates only to APA Networks operated assets (as defined in this document) and does not relate to any other utility assets owned or operated by APA, such as APA Gas Transmission Pipelines.
2. This Guidelines document is provided to You to assist in the development of design plans, construction and land use activities.
3. This Guidelines document does not override or supersede APA’s Permit to Work (**PTW**) or Excavation policies and procedures.
4. Any proposed works in the vicinity of APA Networks operated assets may also require approval from other utility providers or government agencies. APA Networks has no responsibility for, and makes no representation in relation to, any requirements that may be necessary to obtain such approvals.
5. This document does not relieve any person from the requirement to make appropriate Before You Dig Australia (**BYDA**) enquiries, and otherwise discuss any proposed works with APA Networks, either for initial or subsequent works.
6. You must not reproduce this document without APA Networks permission and must not alter or amend this document.
7. To ensure the latest version of this document is used only APA Networks can provide a valid copy of this document.
8. APA Networks reserves its right to modify, amend, supplement, delete or withdraw any part of this document or any reference contained in this document, at any time without notice.
9. You must make your own independent enquiries in relation to any works that are proposed to be undertaken in the vicinity of any APA Networks operated assets (including obtaining all necessary express written consents and approvals from APA Networks). The information contained within is intended as a guide only.
10. Except as required by law and only to the extent so required, APA Networks and its related bodies corporate, officers, employees, agents and Contractors;
  - a) do not make any representation, warranty or undertaking, express or implied, as to, or accept any responsibility or liability for; and
  - b) are not in any way liable, directly or indirectly, to You or any other person for any loss, damages, costs, expenses or reliance arising out of or in connection with the validity, accuracy, completeness, relevance, or any errors in or omissions from, any information or statement contained in this document.
11. APA Networks reserves all its rights in the information contained in this document. No rights or obligations are granted or to be implied from the contents of this document. You acknowledge that all intellectual property and other tangible and intangible rights in the information contained in this document are and remain the exclusive property of APA Networks.
12. You agree to release and indemnify APA Networks and its related bodies corporate, officers, employees, agents and Contractors against all reasonably foreseeable claims, costs, expenses, losses and liabilities (including legal costs on a full indemnity basis) suffered or incurred by them as a result or in connection with the use of this document by You.

The purpose of this document is to provide guidelines for third parties planning to install new infrastructure or conduct works near existing APA Networks (**APA**) operated assets.

It is intended that this document will be provided to third parties proposing works around existing gas assets for their use during the design and planning phase following initial planning BYDA enquiries. This document does not provide authorisation to undertake the works but provides APA requirements to ensure that any review and acceptance of proposed works is completed as quickly as possible.

# 1 INTRODUCTION

## 1.1 Scope of this Document

This document addresses APA’s requirements for considering how a third party’s proposed works and APA managed works may impact APA Networks operated assets under the following parts:

**Part 1** – APA Notification and Authorisation Requirements

**Part 2** – Design and Asset Protection Requirements

**Part 3** – Construction and Land Use Requirements

**Part 4** – Alteration of Existing Gas Assets

APA Networks acts as the asset operator on behalf of entities Australian Gas Networks (**AGN**), Allgas, APA, Origin and Queensland Nitrates (**QNP**) and operates in New South Wales, Northern Territory, Queensland, South Australia and Victoria. The criteria provided in this document only applies to the assets managed by APA Networks on behalf of these companies.

APA also owns and operates natural gas transmission infrastructure on all mainland states and territories of Australia. These assets are operated by a separate APA entity and are out of scope for this document.

A glossary of all terms and abbreviations used in this document is contained in **Section 7**.

A list of all relevant external standards and APA reference documents is contained in **Section 8**.

## 1.2 Asset Types

APA Networks’ operated gas assets include buried pipe, above and below ground stations (e.g. pressure regulation, valves, meters), electrical cables, cathodic protection systems (e.g. test points, anode beds), pits and electrical cabinets. Depending on the gas type and the operating pressure, gas assets are classified as natural gas transmission, natural gas distribution and Liquefied Petroleum Gas (**LPG**) distribution as shown in **Figure 1**.

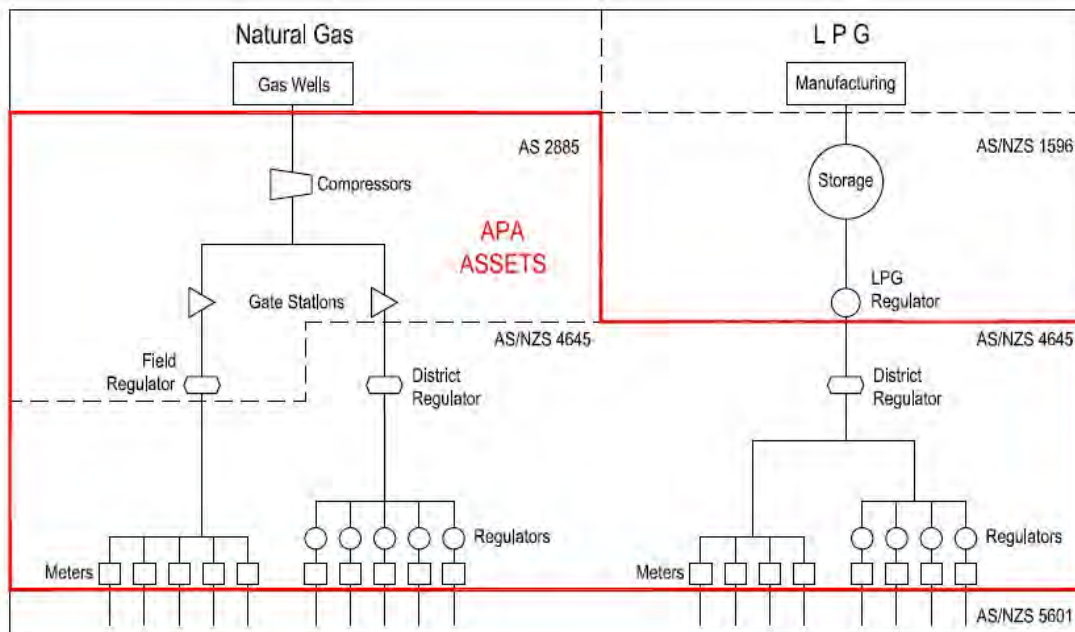

**Figure 1 Asset Types and Standards Operated by APA Networks**

### 1.2.1 Natural Gas Transmission

Natural gas transmission pressure assets operate at pressures above 1,050 kPag, and are generally used for transporting large quantities of gas across country. Design, construction and operation of these assets is governed by the AS 2885 suite of Australian Standards (**AS**).

Due to the higher pressure and energy density, there are severe safety, supply and environmental consequences which can result from third party interference. Hence, more stringent requirements and controls are applied to third party works in the vicinity of these assets.

Buried transmission pipelines are constructed from coated steel pipe where the appearance can vary depending on the year of construction, but will generally appear as yellow, black or grey when physically exposed.

### 1.2.2 Natural Gas Distribution

Natural gas distribution pressure assets operate at pressures below or equal to 1,050 kPag from offtakes of transmission pressure assets, and are generally used to supply consumers such as businesses and homes. Design, construction and operation of these assets is governed by the AS/NZS 4645 suite of Australian Standards.

Due to the lower energy density compared to transmission assets, less stringent requirements and controls are applied to distribution assets. Some distribution assets are deemed critical by APA Networks due to the safety and supply implications that may arise due to a third party strike. These critical distribution assets will be defined on BYDA responses, and some of the controls which are applied to transmission pressure assets (e.g. permit and site watch) will be required.

Buried distribution pressure pipes may be constructed from the following materials and physical appearances when exposed:

- Cast Iron (black);
- Polyethylene (PE) (yellow or black with yellow stripes);
- Steel coated or uncoated (generally yellow, black or grey); and
- Other plastic such as Polyvinyl Chloride (PVC) or nylon (yellow).

Some legacy materials such as cast iron and nylon may require additional protection during construction works due to the unpredictable nature of the materials.

### 1.2.3 LPG Distribution

LPG distribution pressure assets operate at pressures below 140 kPag from storage compounds and are generally used to supply consumers such as businesses and homes in parts of Queensland, South Australia and Northern Territory. Design, construction and operation of these assets is governed by the AS/NZS 4645 suite of Australian Standards.

**Additional safety considerations are required in addition to the requirements for natural gas, as LPG is heavier than air and will pool at the leak point and can accumulate in a trench or excavation.**

The same materials used for buried distribution pressure pipes (**Section 1.2.2**) may be used on LPG distribution networks.

## 1.3 Damage and Emergencies

If you smell gas or damage has occurred, or is suspected, on any gas asset call APA emergency number **1800 GAS LEAK (1800 427 532) or 1800 808 526 for LPG assets.**

Any unreported damage has the potential to escalate and endanger public safety.

Where damage has resulted in a release of gas, you are advised to take the following immediate action:

- Clear the area of all people. Do not under any circumstance re-enter the damage area;
- Where safe to do so, shut off or remove all ignition sources and devices in the area e.g. naked flames, vehicle engines, power tools, mobile phones;
- Do not attempt to stop the flow or repair the damage;
- Allow the gas to vent to air; and
- Once clear of the area, contact the emergency number **1800 427 532 or 1800 808 526 for LPG assets.**

The conditions in this document or as provided by APA Networks are intended to protect the gas assets as well as keep safe any construction crews or general public in the vicinity. Depending on the circumstances, some variation to the conditions in this document may be required or may be provided by an approved APA Networks site watch representative. It is legislated in all jurisdictions that the direction provided by APA is followed.

## 1.4 General Duty of Care and Responsibility to Obtain Information

Anybody working near a gas asset, or responsible for such work, has a duty of care to exercise caution, to maintain a safe working environment and to meet requirements of all relevant laws and Occupational Health and Safety legislation.

For general enquiries about results from BYDA please contact:

- [DBYDNetworksAPA@apa.com.au](mailto:DBYDNetworksAPA@apa.com.au) for Northern Territory, South Australia, Southern New South Wales and Victoria, and;
- [PermitsQLD@apa.com.au](mailto:PermitsQLD@apa.com.au) for Queensland and Northern NSW (incl. Tamworth).

The third party shall make contact with APA through the BYDA process if any clarification is required to determine the approval processes for any proposed land use changes (within the Measurement Length), design works and construction activities within 3 m of a gas asset or within a pipeline easement.

Any works proposed by the third party will only be authorised if APA is satisfied that the works will not affect the integrity of the APA Networks operated assets.

Any person undertaking work near an APA Networks operated asset, or responsible for such work, must ensure that they familiarise themselves with APA requirements.

Working around any gas asset, especially transmission pressure pipelines, without appropriate planning and controls as specified by APA Networks can be extremely dangerous. Damage to a gas asset could result in:

- Possible explosion and fire with the risk of loss of equipment, property, personal injury, and death;
- Loss of gas supply to thousands of customers;
- Substantial repair and gas restoration liability costs to the authority or principal responsible; and,
- Prosecution under the relevant laws governing pipeline and gas safety.

**Prior to the commencement of any works within the Protected Zone of transmission pressure or critical gas assets, the Contractor performing the work must receive an Authority to Work Permit (ATWP).**

Any works within the Protected Zone of critical assets must comply with any conditions attached to an ATWP and depending upon the nature of the asset and works supported by an approved construction methodology.

Written authorisation in the form of the ATWP must be kept on site at all times, and the holder of the authorisation must comply with all the conditions of the ATWP. The performance of any works near critical APA Networks operated assets without a valid ATWP and full compliance with its conditions will constitute a safety incident and may also result in an infringement notice and associated penalties issued by the regulator of the APA Networks asset.

### 1.4.1 Additional Transmission Pressure Pipeline Requirements

Where the works proposed by the third party may result in a change in land use within the Measurement Length for a transmission pressure pipeline (as defined in AS/NZS 2885.6 for Pipelines – Gas and Liquid Petroleum), such works may also be subject to formal approval requirements through APA Networks and applicable local and state government planning processes. This may also require a Safety Management Study (**SMS**) Report to be completed and approved by APA Networks. The SMS Report is generated from an SMS workshop involving an SMS facilitator, the third party and APA Networks. APA Networks is the owner of the SMS Report and any resulting recommendations/ actions must be implemented to the satisfaction of APA prior to the commencement of any physical works.

Certain categories of development/ land use change are not appropriate to be located within the Measurement Length of transmission pressure pipelines. In certain circumstances, the otherwise unacceptable risks associated with such developments may be alleviated with the aid of installing protective slabbing over the asset or undertaking other protection and mitigation measures.

## 2 PROTECTION PROCESS

APA is committed to working cooperatively with third parties to ensure that existing gas assets will be appropriately protected from any proposed works.

The process to be followed for any proposed works is outlined in **Table 1**. This table cross references the relevant section of this document which provides any specific requirements for each gas asset classification. The steps in this table are to be followed in conjunction with the process outlined by BYDA<sup>1</sup>, a flow chart is also provided in **APPENDIX A**.

**Table 1 Protection Process Summary**

Section	Step	Purpose
3	<b>Notification and Authorisation</b>	<p><b>Identify and locate existing gas assets in the vicinity of any proposed works.</b></p> <p>Submit BYDA requests to obtain indicative plans of gas assets.</p> <p>Notify APA Networks and obtain approval to verify the exact position by physically proving the position of gas assets at the cost of the third party.</p>
4	<b>Design and Protection Requirements</b>	<p><b>Review APA Networks design and protection requirements for any proposed infrastructure near gas assets.</b></p> <p>If acceptable clearance is available in accordance with this section review impact of construction methodology on existing gas assets.</p> <p>If acceptable clearance is not available in accordance with this section and the proposed infrastructure cannot be modified, alteration or protection of the existing gas assets will be required at the cost of the third party.</p>
5	<b>Construction and Land Use Requirements</b>	<p><b>Review construction methodology for adverse impact to existing gas assets.</b></p> <p>Some additional protection measures may be required depending on the existing gas assets, the construction methodology and whether land use changes are required.</p> <p>If works meet the requirements of this document, submit work package to APA Networks for review and approval. If approval is given, then undertake works in accordance with APA Networks conditions/ permits. If approval is not given modify work package accordingly.</p> <p>If works do not meet the requirements of this document or APA Networks approval cannot be reached, alteration or protection of the existing gas assets will be required.</p>
6	<b>Alteration</b>	<p><b>Request alteration of existing gas infrastructure if there is insufficient clearance or construction methods will adversely impact existing gas assets.</b></p> <p>Alteration of existing gas assets are fully recoverable and may result in delays if not identified early.</p>

### 2.1 Assessment Information

Throughout the protection process, APA Networks assessment may be required to determine if the proposed works/ installation has sufficient separation or if work can be undertaken with a suitable construction methodology. If APA Networks assessment is required, the following information must be provided to enable an efficient and comprehensive review.

- Due dates or a work program;
- The location / address and extent of proposed works;

<sup>1</sup> BYDA process is available at <https://www.1100.com.au/safety-information/digging-safely/>

- Scope / description of the work impacting APA assets;
- A work package containing detailed design or construction issue drawings with the location of APA assets and the extent of works marked and / or georeferenced. Sufficient details must be provided on the plans to verify locations against APA information, which is typically measured from property boundaries. Plan and cross sectional drawings are typically required, including any proving locations;
- The proposed construction methodology (if available); and
- For critical assets only, a completed permit request form. This form is automatically provided in response to a BYDA enquiry when it is required, with direction for this form included in the BYDA response (refer to **Section 5.2**).

If the information provided is incomplete, or irrelevant information is provided, it may result in a delay of the assessment process and provision of a response. Due to the varying nature of potential works, it is not possible to develop a comprehensive listing of information that will be required for each work type, but the above is provided as a general guideline for what will normally be required.

## 3 PART 1 - APA NOTIFICATION AND AUTHORISATION REQUIREMENTS

### 3.1 BYDA Request

The fastest method for obtaining APA Network gas asset locations is to lodge a BYDA request. A response can be expected from APA within two business days, and may include one of three responses as outlined in **APPENDIX A**, depending on the location of the works in relation to existing APA operated gas assets in the vicinity.

For some BYDA requests, APA Networks may provide different responses to different assets affected by the proposed works. In all instances it is the responsibility of the third party to review and follow the direction of all BYDA responses.

The information provided by APA Networks in response to a BYDA request, along with any other plans or subsequent information provided by APA, show only the indicative location of the asset at the time and are a guide only. In most instances it will be necessary to prove the location of all buried assets within the proposed work area.

The following items must be considered when using asset information provided by APA Networks:

- Gas service lines from buried distribution pressure supply mains to consumers may not be shown on plans. Service lines are usually laid at right angles from main to a meter position, except where road conduits are provided; and
- Plans become rapidly outdated and so should be used within 30 days and then destroyed. It is the responsibility of the third party to contact APA Networks to seek the updated or renewal of any information after this time.

APA shall not be liable or responsible for the accuracy of any information supplied.

### 3.2 Provings and Site Identification

Electronic location (e.g. ground penetrating radar, pipe locators) of gas assets is required to verify the onsite locations and any plans that have been provided.

Physical proving of existing gas assets is required at key locations to verify that the separation and protection criteria provided in this document have been achieved. The location and quantity of provings will depend on the scope of proposed work, but provings will at least be required at infrastructure crossing points or where changes to surface level condition are planned.

Additional verifications are required for works parallel and in close vicinity to existing gas assets. Physical provings at maximum 10 m intervals along straight sections of pipe, along with all bends, branch lines and customer service offtakes to verify asset locations.

**Note:** Live service offtakes which no longer supply consumers may protrude from the gas asset and are not traceable or identifiable from records.

**Note:** The maximum physical proving intervals for straight sections of pipe may be adjusted based upon the discretion of APA personnel for extenuating circumstances.

The following items must be considered when proving the location of an existing gas asset:

- Provings must be conducted safely and in accordance with the requirements of **Section 5.5.2**. If damage to a gas asset does occur it should be reported immediately to APA as described in **Section 1.3**.
- Permit and site watch by an APA Networks representative may be required for some proving activities in accordance with **Section 5.2**.

### 3.3 APA Notification and Authorisation Process

Prior to the third party undertaking any works/ activities or as part of the planning and design phase, the third party shall ensure a BYDA request is submitted. The automated response received from the BYDA system will be tailored based on the criticality of the assets.



For assets operated at distribution pressures and not considered critical mains, a Duty of Care Notice is provided with the BYDA response for the third party to consider. Site watch may be necessary under a duty of care notice where additional protection or other integrity concerns require it.

In the event that works are conducted within the Protected Zone of a transmission pipeline and/ or critical distribution main, these works will require a review approval received from APA prior to commencement of works. Works subject to this requirement are deemed to include, but not limited to, the following activities that fall under **Table 3**;

- Non Destructive Digging (**NDD**);
- Mechanical excavation including trenchless excavation i.e. drilling (boring, horizontal direction drilling (**HDD**), pipeline bursting and tunnelling) for installing infrastructure such as the following;
  - o Roadways, driveways, railways, pavements;
  - o Electrical equipment (cables, overhead transmission lines, telecommunication cable or power poles);
  - o Installation of culverts/ pipes (water, drainage, sewer or reticulation); o Landscaping.

APA will not approve certain activities and structures in the transmission pipeline easement (if applicable), including the following;

- Permanent storage;
- Installation of billboard structures;
- Use and storage for explosives, flammables or corrosives;
- Blasting;
- Structures forming part of any house, house extensions, carports or entertainment areas;
- Dams and other manmade water features. Locations of dams off the pipeline easement/ protected zone must not create run off or drainage towards the pipeline easement;
- Chemically treated effluent coming in contact with the pipeline easement/ protected zone;
- Garbage, sand fill, refuse disposal;
- Airstrips.

The Third Party must submit an enquiry to APA at the earliest possible stage to allow sufficient time for assessment. Submissions should include the following information;

- Land description and map identifying location of the proposed works;
- Types of works to be carried out;
- Intended future use of the land (where relating to change in land use)
- Type and weight of machinery that will be used;
- Any plans or diagrams of the works;
- Timeframe for the works.

The sequence of obtaining APA approval is as follows;

- a) Submit enquiry for Initial Review – The Third Party submits the request prior to works commencing and APA Networks will complete an 'Initial Review'. The third party must not progress any works on site until they receive a response from APA Networks. The two possible outcomes of this stage are a 'No Impact' response or;
- b) Enquiry Escalated for Standard Assessment – The request will be forwarded to APA Networks Field or System Operations personnel for a more detailed appraisal, which may involve contacting the third party, site visits, locating of assets of site, and/or request for additional information. The third party must not progress any work on site until they receive a response from APA Networks. The two possible outcomes of this stage are a 'No Objection under standard conditions' response or;
- c) Enquiry Escalated for Engineering Assessment – The request has been forwarded to the Integrity Third Party Engagement team for additional appraisal and determination of specific conditions. The third party must not progress any works on site until they receive a response from APA Networks. The two possible outcomes of this stage are a 'No Objection under special conditions response' or;

- d) Enquiry Escalated for Alteration – The Integrity Third Party Engagement team triggers the alteration process for this enquiry. The third party will be contacted for additional information and must not progress any work on site until they receive a response from APA Networks.
- e) No Impact – The third party receives a ‘No Impact’ response and can proceed with the works under appropriate APA Networks requirements e.g. Duty of Care, Authority to Work Permit and/or Site Watch.
- f) No Objection Under Conditions – The third party will receive a No Objection under standard or special conditions response and can progress with the planning of the works under the conditions specified in the response and appropriate APA Networks requirements e.g. Duty of Care, Authority to Work Permit and/or Site Watch.

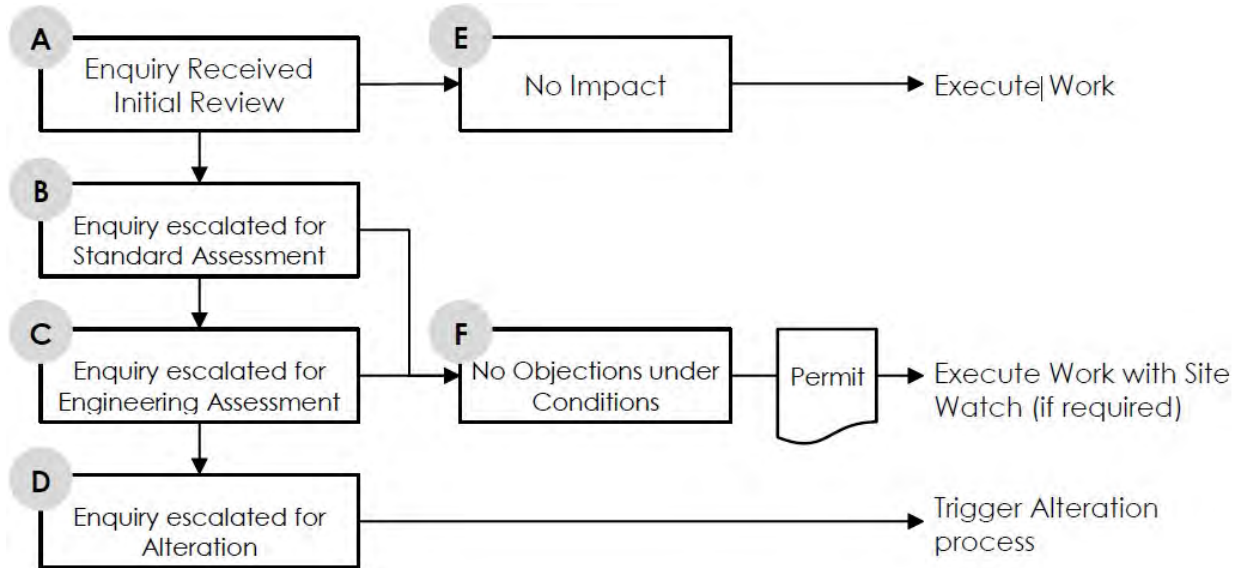

**Figure 2 Stages for Third Party Works Authorisation Request**

For works around APA Networks transmission pipelines or critical mains the documents take precedence in the following order;

- APA Authority to Work Permit (**ATWP**)
- APA accepted Third Party Construction Drawings
- APA accepted Third Party Construction Methodology
- APA Networks Guidelines for Works Near Existing Gas Assets (this document)
- APA accepted Third Party Safe Work Method Statement (**SWMS**) (if applicable)

### 3.4 Commercial Agreement and Service Delivery

APA will undertake a review of Third Party Works, as required. At APA’s discretion cost recovery for these works may be required. Where APA Networks requires cost recovery a commercial service agreement in the form of a Works Agreement will be required.

**Note:** Any third party works requiring blasting, seismic and/or tunnelling work near APA Networks operated assets will not be considered “low risk” and cost recovery for detailed review maybe required.

### 3.5 Decommissioned Gas Assets

Decommissioned gas assets that remain in the ground are not always shown on BYDA plans.

Where unknown assets are identified or suspected on site but are not on APA plans, they must be treated as being live. In this instance, the third party must contact all utility owners and operators in the area of the BYDA and notify them of the findings.

Following review, if APA accepts that it is a decommissioned gas asset, the asset must be treated as per the requirements of this document. APA will take no further action where it is not considered to be a decommissioned gas asset.

In some cases, decommissioned gas assets are required for future use by APA (sometimes noted as “Idle” on APA plans). These assets must be treated as live using the same criteria outlined in this document, and must not be removed or altered without APA’s express written approval.

Where APA confirms there is no future use of a decommissioned gas asset (sometimes noted as “Abandoned” on APA plans), removal of the asset can be undertaken by the third party under the following conditions:

- For assets considered by APA to be decommissioned gas assets, APA must be engaged to verify that the asset is gas free;
- End caps must be permanently sealed, using an APA approved methodology, on any decommissioned sections that are to be left in place to prevent future water ingress into the remaining sections of the decommissioned gas asset;
- An as-built drawing must be submitted by the third party for any section(s) of a decommissioned gas asset removed by the third party or its sub-contractors to ensure BYDA can be updated accordingly; and
- Payment for costs associated with any verification or alteration activities must be provided prior to APA undertaking works.

## 4 PART 2 - DESIGN AND ASSET PROTECTION REQUIREMENTS

### 4.1 Standard Clearances

Minimum clearance dimensions outlined in this section must be met to allow for safe future maintainability and protection of existing gas assets. If separation clearances cannot be achieved, APA will review the proposed infrastructure on a case-by-case basis to determine whether a resolution can be achieved before alteration of any existing gas assets is considered. Authorisation of works by APA is still required, regardless of being able to achieve the required separation distances.

Clearances specified in **Table 2** are measured from the closest edges of the existing gas asset to the proposed infrastructure. Depending on the exact nature of proposed infrastructure, additional clearance may be required.

**Note:** Clearances specified herein are from gas assets, third party utilities may have their own standard separations that exceed APA's minimums specified in **Table 2**.

The future access zone required around a gas asset depends upon a number of factors such as size, operating pressure, depth and soil conditions, but typically this access zone is at least 1000 mm either side and 700 mm below the gas asset. As an aid for design and / or installation, the minimum clearances presented in **Table 2** are provided to allow for safe future access to gas assets. These minimum clearances assume that the asset have been proven and the location verified. There may be circumstances where additional clearances are required.

**Table 2 Minimum Clearances**

Clearance Type (Note 2, 9)	Minimum Transmission Pressure Asset Clearance	Minimum Distribution Pressure Asset Clearance
Any installation up to 0.6 metres wide which is crossing the gas asset	500 mm Vertical <b>(Note 2)</b>	300 mm Vertical <b>(Note 2)</b>
Any installation over 0.6 metres wide which is crossing the gas asset	500 mm Vertical	300 mm Vertical <b>(Note 2)</b>
Any installation laid by trenchless excavation e.g. HDD, boring, etc.	3000 mm Vertical	600 mm Vertical
	Refer to <b>Section 5.6</b> for minimum horizontal separation distances	
Any installation laid parallel to a steel gas asset	600 mm Horizontal <b>(Note 2, 3)</b>	
Any installation laid parallel to any gas asset other than steel	N/A	300 mm Horizontal <b>(Note 2, 3)</b>
Trenching separation from edge of gas asset to edge of trench <b>(Note 4)</b>	500 mm Horizontal	300 mm Horizontal
Underground electrical cables laid parallel to any gas asset other than steel	N/A	300 mm Horizontal
Electrical conduits and cables (<11 kV) laid parallel to a steel gas asset	Engineering assessment required <b>(Note 2, 3)</b>	
Electrical conduits and cables (≥ 11kV) laid parallel to a steel gas asset	<b>(Note 2, 3)</b> Engineering assessment required <b>(Note 7)</b>	

Electrical earthing systems near a steel gas asset	High Voltage: Engineering Assessment Required Low Voltage: 300 mm Horizontal <b>(Note 7)</b>	
Electrical earthing system near any gas asset other than steel	N/A	300 mm Horizontal
<b>Clearance Type (Note 2, 9)</b>	<b>Minimum Transmission Pressure Asset Clearance</b>	<b>Minimum Distribution Pressure Asset Clearance</b>
Undisturbed cover from the top of the gas asset to the underside of trenching or road pavement boxing	500 mm Vertical	300 mm Vertical <b>(Note 1)</b>
Distance from predominant building line	3000 mm Horizontal Where applicable outside pipeline easement	Refer to <b>Section 4.2</b>
Distance from Sensitive Use Locations (Refer <b>Section 7</b> for Glossary of Terms and Abbreviations)	APA Engineering Assessment Required <b>(Note 8)</b>	N/A
Canopies longer than 15 m parallel to the edge of the gas asset	3000 mm Horizontal <b>(Note 10)</b>	Refer to <b>Table 4 (Note 10)</b>
Any installation that could add excessive loads to the gas asset or restrict access to the gas asset	3000 mm Horizontal <b>(Note 2)</b>	
Any installations that may need require underpinning were APA to expose the gas asset	3000 mm Horizontal	
Any temporary stake, e.g. star picket	300 mm Horizontal	
Electrical poles including street lighting and traffic signals	3000 mm Horizontal Where applicable outside pipeline easement	1000 mm <b>(Note 3, 5, 6, 7)</b>
Fence post, including road safety barriers	3000 mm Horizontal when installed per APA requirements	500 mm Horizontal when installed per APA requirements
Pile or pier	3000 mm Horizontal when installed per APA requirements	500 mm Horizontal when installed per APA requirements
Permanent Heavy Vehicle Loads (Greater than 4.5T)	Refer to <b>Section 4.7</b> Temporary and Permanent Vehicle Loads	
Tree Root Barrier	3000 mm Horizontal	1000 mm Horizontal Refer to <b>Section 4.3</b> Landscaping Plans
Separation distances for vegetation	Refer to <b>Section 4.3</b> Landscaping Plans	

**Note 1:** For distribution main crossings, where the vertical separation distance is less than 300 mm physical protective slabbing, e.g. HDPE or concrete, shall be installed where the other utility is crossing beneath the APA pipeline/distribution main.

HDPE or concrete, shall be installed where the other utility is crossing above the APA pipeline/distribution main.

No protective slabbing is required for utility crossings greater than 500 mm separation.

**Note 2:** Structures and large utilities crossing APA Networks operated assets need to be self-supporting so that future repairs or maintenance of the asset can occur as per **Section 4.2 Third Party Assets and Structures**.

**Note 3:** Horizontal separation includes utility surface access pits, thrust blocks and/ or footings.

**Note 4:** Additional horizontal separation may be required depending on the extent of the planned works, local soil conditions and trench stability of the existing gas asset. This is particularly relevant where works occur within the angle of repose of the existing gas asset (e.g. parallel trenching that is deeper than the existing gas asset) and may result in undermining.

**Note 5:** In accordance with 'AS/NZS 4853 – Electrical hazards on metallic pipelines' without further information and APA engineering assessment, no electrical power poles for 66kV or above are permitted within the following separation distances of steel gas assets;

- If the power line has an Overhead Earth Wire (**OHEW**) – 15 m;
- If power line does not have an OHEW – 100 m;

**Note 6:** Where electrical poles (including street lighting and traffic signals) are proposed which place the gas asset within the no dig zone specified by the electrical authority either of the following shall occur;

- a) The poles shall be designed with deeper foundations to be self-supporting if the gas asset needs to be excavated. Or;
- b) For non-metallic assets relocated into a conduit that extends past the no dig zone.

**Note 7:** Clearance for electrical cables and earthing systems from steel gas assets must be reviewed in accordance with **Section 4.6 Earthing and Electrical Effects**. Electrical cables, substations and/or earthing systems installed in the vicinity of steel gas assets require an Earth Potential Risk (**EPR**) and Low Frequency Induction (**LFI**) assessment to AS/NZS 4853.

**Note 8:** Requires a setback distance to stay away from the Measurement Length (refer to **Table 14 Glossary of Terms and Abbreviations**). Alternatively, the setback distance may be reduced if protection slabbing is installed along the Sensitive Use Location where interaction with the Measurement Length occurs. This may also be limited to the development area subject to APA engineering assessment.

**Note 9:** Pipeline protection needs to be assessed and shown on the design plans with design clearances. This includes recoating, bridge slab or asset strike protection slab.

**Note 10:** Clearance may be dependent on demonstrating that there is sufficient continuous ventilation.

For construction and land use activities around gas assets the minimum horizontal clearances referenced in **Table 3** must be followed.

**Table 3 Minimum Clearances for Construction Works and Land Use Activities**

Construction and Land Use Activities	Minimum Horizontal Clearance	
	Transmission Pressure & Critical Distribution Mains	Non-Critical Distribution Pressure Mains
Excavation without APA representative present ( <b>Note 1</b> )	3000 mm	N/A
Trenchless Excavation ( <b>Note 1</b> )	3000 mm Refer to <b>Section 5.6</b>	1000 mm Refer to <b>Section 5.6</b>
Temporary Heavy Vehicle Traffic (greater than 4.5T)	If the load has not been assessed, maintain a Horizontal separation of 3000 mm.  APA engineering assessment must be completed if crossing asset.  Refer to <b>Section 4.7</b> Temporary and Permanent Vehicle Crossings	Refer to <b>Section 4.7</b> Temporary and Permanent Vehicle Crossings
Installation of Piles, Piers or Poles	Refer to <b>Table 2</b> and <b>Section 5.7</b>	
Hot Works from Construction Activities	Any hot works within 5000 mm of an open trench containing gas asset or where cover is less than 300 mm. Refer to <b>Section 5.8. (Note 2)</b>	
Compaction	<b>Section 5.10</b> for Compaction Limits Maximum Compaction Limits	
Vibration Limits	No vibration within 3000 mm of the pipeline and greater distance to comply with <b>Section 5.9</b>	
Blasting, Seismic Survey or the use of Explosives	Approval required for works within 100m. Refer to <b>Section 5.11</b> .	
Lifting over exposed gas asset	Not permitted over the gas asset. Refer to <b>Section 5.12</b> for Suspended Materials above Gas Assets and No Go Zones for Cranes.	
Clearance of crane outriggers to gas assets	Not permitted within 3000 mm of gas asset. Refer to <b>Section 5.12</b> for Suspended Materials above Gas Assets and No Go Zones for Cranes.	
Clearance of temporary material from pipeline	Not permitted within 3000 mm of gas assets. Refer to <b>Section 5.13</b> for Temporary Materials.	

**Note 1:** Excavation covers NDD, mechanical excavation and trenchless excavation (boring, HDD, pipeline bursting and tunnelling).

**Note 2:** Horizontal separation distance also applies to any pits or valve covers.

## 4.2 Third Party Assets and Structures

Structures, including but not limited to buildings, walls, canopies, footings, pile caps or retaining walls, must not transfer any load to or be installed over any gas asset.

The design of any third party asset or structure must take into account future safe access of any gas assets in the vicinity. The proposed third party asset or structure must be installed in a way that prevents the angle of repose from encroaching into the future access zone as specified in **Section 4.1** around the existing gas asset.

Any third party asset or structure installed within proximity to a transmission pipeline or critical distribution pressure main must be designed to be self-supporting and allow for a minimum excavation window 1m on either side of the asset and 700 mm below the edge of the asset, for maintenance of the asset. This self-supporting design information is required to be shown on the construction drawings supported by geotechnical data and calculations. Construction of structures on pipeline easements are not permitted without explicit consent from APA.

Distribution pressure gas mains must be offset from the expected predominant building line at a distance in accordance with **Table 4**. Transmission pressure gas assets shall be per **Table 2**.

**Table 4 Minimum Building Offset Distances for Distribution Pressure Gas Mains**

Diameter (DN)	MAOP (kPag)			
	≤210	>210 ≤ 420	>420 ≤ 600	>600
≤110	0.5 m	0.5 m	1.0m	3 m
>110 ≤ 160	0.5 m	0.5 m	3 m	5 m
>160	0.5 m	3 m	3 m	8 m

Gas assets may be located underneath curbing or strip footings for road safety barriers for short sections up to 10 m to allow for tapers. The integrity of the gas asset to be located underneath the curbing or strip footing may require inspection, repair, recoating and / or slabbing depending on the existing condition and extent of proposed works.

Posts or poles which are located in road reserve, or otherwise exposed to vehicle impact, must be designed such that there will be no damage to the gas asset in the event of a vehicle impact.

For works in Victoria, consent from the relevant State Minister is required under Section 120 of the *Pipelines Act 2005* (VIC) for the erection of structures or buildings within 3,000 mm of a transmission pressure asset. Ministerial consent must be arranged through Energy Safe Victoria (**ESV**) following review and acceptance of the proposed designs by APA Networks.

## 4.3 Landscaping Plans

Vegetation may limit line of site, access and passage along an existing gas asset alignment, while the associated roots may damage existing buried pipe, coating or other ancillary equipment (e.g. cables). Above ground gas infrastructure may also be exposed to hazards from falling vegetation and increased fire risk. Additionally, trees and tree roots may limit access to the gas asset in an emergency, during normal operations and when make new connections or modifications.

Landscaping plans which include vegetation should select tree species which do not have vigorous root activity and do not exceed above 5m in height when fully mature when planted within 3m of gas assets. The pre-selection of trees considered suitable for planting within road reserves and near gas assets should also consider interference with, or damage to, other underground and overhead services.

For all landscaping works within 3 m of transmission pressure or critical distribution pressure gas assets the following details must submitted to APA for review and approval prior to planting.

- Tree species – botanical and common name
- Mature tree buttress and canopy diameter
- Mature tree height



- Maximum root ball diameter
- Offset from gas asset
- Method of protection to gas asset

Trees to be planted within 3 m of transmission pressure or critical distribution pressure gas assets, should also adhere to **Table 5** below.

**Note:** Horizontal separation is measured from pipe edge to edge of mature trunk or mature drip line, whichever is the greater.

Strata cells are not considered an appropriate protection from tree roots. If strata cells are to be installed in the vicinity of existing buried gas assets, the controls identified in **Table 5** must be used for protection.

**Table 5 Protection of Distribution Gas Assets from Vegetation**

Vegetation Types	Requirements	Horizontal Separation from Pipe Edge to Vegetation			
		Greater than 3 m	1.5 to 3m	1.5 to 0.5 m	<0.5 m
Trees or Large Shrubs	Min. separation of 3 m is required between trees and pipe if no protection methods are utilised.				
Medium and Small Shrubs	Within 1.5 m – 0.5 m protection methods must be utilised.				
Ground cover and grasses	No protection methods required.				
Gas Protection Methods					
	No protection methods required, provided separation limits are followed.				
	<p>Within 3 m, tree species which have mature buttress diameters less than 0.15 m and do not have invasive or deep roots may be accommodated without protection methods after consultation with APA Networks (<b>Note 1</b>).</p> <p>For trees with mature buttress diameters greater than 0.15 m one of the following gas protection methods must be implemented;</p> <ol style="list-style-type: none"> <li>1. Lowering or relocation of the gas asset to a minimum of 1.2 m cover.</li> <li>2. Installation of new gas conduit beyond the structural root zone (<b>SRZ</b>) of the mature tree species for future use. (<b>Note 2</b>)</li> <li>3. Installation of a root barrier system. System to be 1 m deep or extend 250mm below the gas asset, whichever is the greater.</li> </ol>				
	<p>Within 1.5 m installation of a root barriers system is mandatory and gas protection methods are as follows;</p> <ol style="list-style-type: none"> <li>1. Installation of a robust root barrier system. System to be 1 m deep or extend 250 mm below the gas asset, whichever is the greater.</li> </ol> <p><b>AND</b></p> <ol style="list-style-type: none"> <li>2. Lowering or relocation of the gas asset to a minimum of 1.2 m cover.</li> </ol> <p><b>OR</b></p> <ol style="list-style-type: none"> <li>3. Installation of new gas conduit beyond the SRZ of the mature tree species for future use. (<b>Note 2</b>)</li> </ol>				
	Planting directly over gas assets is not permitted in any location, as it prevents emergency and maintenance access. Tree roots can damage gas asset resulting in gas leaks.				

**Note 1:** Refers to the minimum 1.5 m structural root zone for a mature buttress diameter less than 0.15 m mandated under AS 4970 – Protection of trees on development sites.

**Note 2:** Suitable protection method for PE mains only. Conduits to be recorded in Geographic Information System (GIS) for future referencing.

**Note 3:** On transmission pressure assets vegetation must not limit line of site along the buried gas assets alignment, all signage must remain each in sight of the other.

#### 4.4 Surface Levels and Conditions

Decreases or increases to surface levels must consider depth of cover requirements for gas assets specified in **Table 6**. This is in addition to maintaining a minimum working cover from the top of the gas asset to the underside of trenching or road box out works during construction as specified in **Table 2**. Vehicles must not cross gas assets at covers less than those specified in **Table 6** unless in accordance with **Section 5.10** for Compaction Limits or **Section 4.7** for Temporary and Permanent Vehicle Crossings.

Where existing surfaces are to be modified, finished cover levels are not to be reduced to less than existing levels, unless meeting the minimum requirements of **Table 6**. The requirement for, and the extent of, protective slabbing over any APA Networks operated asset will be determined by APA at its sole discretion with adherence to minimum depth of cover without physical protection as the preference. Depending on the location, local councils and relevant road/ rail authorities may have minimum depth of cover requirements that APA are required to meet which are more stringent than those listed in **Table 6**. Depth of cover requirements for individual consumer offtakes (service connections) are also provided in **Table 7**.

Details of any additional fill proposed to be placed on or within 3 metres of a gas asset, or within any applicable easement, must be clearly shown on plans and must be approved by APA Networks in writing. A maximum depth of cover of 2,500 mm for transmission pressure assets and 2000 mm for distribution assets apply in all locations; however, it is preferred not to exceed 1500 mm for both types of assets.

**Table 6 Minimum Depth of Cover Requirements for Pipelines and Mains**

Asset Location	Minimum Depth of Cover (Note 3)	
	Transmission Pressure Asset	Distribution Pressure Asset
Under Minor Road Pavement ( <b>Note 1</b> )	<ul style="list-style-type: none"> <li>1,200 mm</li> <li>1,200 mm to 1,000 mm with physical protection slabbing and APA engineering load assessment</li> </ul>	<ul style="list-style-type: none"> <li>750 mm</li> <li>750 mm to 600 mm with physical protection slabbing and APA engineering load assessment</li> </ul>
Under Major Road Pavement ( <b>Note 2</b> )	<ul style="list-style-type: none"> <li>1,200 mm</li> <li>1200 mm to 1,000 mm with bridging slabs (<b>Note 4</b>)</li> </ul>	<ul style="list-style-type: none"> <li>1,200 mm</li> <li>1200 mm to 750 mm with bridging slabs (<b>Note 4</b>)</li> </ul>
In Road Reserve but not Under Road Pavement	<ul style="list-style-type: none"> <li>900 mm</li> <li>900 mm to 750 mm with protective slabbing contingent upon pipeline location class</li> </ul>	<ul style="list-style-type: none"> <li>750 mm</li> <li>750 mm to 600 mm with protective slabbing</li> </ul>
Not in Road Reserve	<ul style="list-style-type: none"> <li>900 mm</li> <li>750 mm with protective slabbing contingent upon pipeline location class</li> </ul>	<ul style="list-style-type: none"> <li>750 mm for &gt; 210 kPa</li> <li>600 mm for ≤ 210 kPa</li> </ul>
Railway Reserve	2000 mm ( <b>Note 5</b> )	
Large Open Drain or Major Water Crossing	2000 mm ( <b>Note 6</b> )	

**Note 1:** Minor road pavements typically are owned by local councils.

**Note 2:** All roads owned by state and federal authorities are major roads. Roads owned by council may be major or minor roads. Covers less than 1200 mm may require dispensation from the relevant road authority.

**Note 3:** Protective slabbing must be installed where minimum depth of cover requirements cannot be met or are required to meet specific safety requirements. Bridging slabbing for transmission pressure assets may be replaced with protection slabbing following APA engineering assessment.

**Note 4:** The requirement for bridging slabs can be downgrade to physical protection slabbing where APA engineering assessment is completed and approved.

**Note 5:** Installation within railway reserve shall be in accordance with both AS 4799 and the respective operating standard for the gas assets i.e. AS 2885 and AS 4645.

**Note 6:** The minimum depth of cover of 2,000 mm shall consider future scour of the drain or waterway crossing. For man-made drains the depth of cover can be reduced to 1200 mm if sealed (i.e. concreted) and appropriately designed. For transmission pressure assets, waterway crossings shall be designed in accordance with AS 2885.1 – 2018 Clause 5.8.6.2. For all assets, as a minimum the following shall be considered;

- a) A hydrological investigation to determine the stream power under peak stream, watercourse or waterway flows. The investigation shall determine the 1 in 100 year flood and the probable maximum flood and intermediate (optional) flood conditions.
- b) A geotechnical investigation to determine the physical parameters of the crossings, and using the information from the hydrological investigation, the erosion potential. This assessment should also consider the meander potential of the watercourse so that the limits of special construction can be defined.

**Table 7 Minimum Depth of Cover Requirements for Customer Offtakes (Services)**

Asset Location	Customer Offtake size	
	≤ DN50	> DN50 and ≤ DN110 (Note 1)
Roadway	450 mm	600 mm
Private Property	300 mm	450 mm

**Note 1:** Customer offtakes (services) with diameters greater than DN110 shall have depth of cover in accordance with **Table 6**.

Changes to surface conditions (e.g. changing from nature strip to road pavement) or which place the gas asset in an inaccessible position (e.g. with excessive cover) may require slabbing, recoating and / or relocation. Changes to surrounding surface levels or conditions must also consider drainage and the potential to result in erosion of cover for gas assets. Additionally, gas fittings such as valves, stopple fittings or flanges must not be located underneath road pavement. An APA Engineering assessment will be required if this is not feasible, refer to **Section 6**.

Where a new hardstand surface is installed on non-metallic distribution pressure mains (e.g. a painted concrete driveway), consideration should be given to including a casing or enveloper pipe to APA requirements for insertion of future gas assets. This will ensure that the new hardstand surface is not modified as part of the future gas installation. Where a casing or enveloper pipe is installed for future insertion works surveyed as-constructed records are to be provided to APA Networks for incorporation into the GIS records.

For transmission pressure gas assets, any landscaping material should be level within the easement or a minimum of 3 m (but preferably 6 m) to each side of the pipeline, to permit excavating equipment to operate without having to destroy the adjacent landscaping.

## 4.5 Casings Vent Stacks

Casings provide mechanical protection and protection to gas assets from external loadings. Some cased crossings are sealed and fitted with a casing vent stack, which gas leaks are identified via.

The following APA requirements are to be applied for works near casing vent stacks:

- Casing vent stacks cannot be removed unless an alternative arrangement has been approved by APA Networks or they have been assessed as being redundant;
- Unfettered access is to be maintained to casing vent stacks; and
- Minimum distance from casing vent stack discharge point to any electrical installation or overhead structure must be 1000 mm.

## 4.6 Earthing and Electrical Effects

Steel gas assets are susceptible to adverse effects from electrical sources such as above and below ground cables, substations, transformers, earth rods, cathodic protection systems or electrified tram / train lines.

Without any further information or engineering assessment, earthing systems for distribution ( $\geq 11\text{kV}$ ) and transmission ( $\geq 66\text{kV}$ ) power lines must satisfy the Earth Potential Rise (EPR) Level 1 (Conservative) compliance of AS/NZS 4853 – 2012 Table 4.3 & 4.5 which specifies separation distances from pipe appurtenances (e.g. valves, regulators, isolation joints), access points or earth points (including cathodic protection test points). For the potential hazards to be accepted as low risk on the basis of a Level 1 assessment the separation between a conductive structure or substation and pipeline subject to EPR shall be greater than the values given in **Table 8** below.

**Table 8 Separation Distances for Pipeline Subject to EPR from Power Lines (Level 1 Assessment)**

Fault Current or Actual Current (A)  (Note 2, 3)	Separation Required (m) - Note 1				
	Distribution ( $\geq 11\text{kV}$ )	Power Line	Transmission ( $\geq 66\text{kV}$ )	Power Line	
	100 $\Omega\cdot\text{m}$	500 $\Omega\cdot\text{m}$	100 $\Omega\cdot\text{m}$	500 $\Omega\cdot\text{m}$	
150	40	190	N/A	N/A	
300	80	390	N/A	N/A	
500	130	660	N/A	N/A	
750	200	1,000	N/A	N/A	
1,000	270	1,300	60	310	
3,000	N/A	N/A	190	940	
6,000	N/A	N/A	380	1,900	
10,000	N/A	N/A	635	>3,500	

**Note 1:** Earth resistivity of 500  $\Omega\cdot\text{m}$  shall be used for dry sand or rock and 100  $\Omega\cdot\text{m}$  for all other cases.

**Note 2:** If the fault current is unknown for a distribution power line ( $\geq 11\text{kV}$ ), a fault current of 1000 A shall be used for the first pass assessment.

**Note 3:** If the transmission power line ( $\geq 66\text{kV}$ ) uses an OHEW, uses values up to 3,000 A (this assumes a current split of 30% of 10 kA). For lines without an OHEW, use values up to 10,000 A for current going down the structure.

Without any further information or engineering assessment, distribution ( $\geq 11$  kV) and transmission ( $\geq 66$  kV) power lines parallel to steel gas assets must satisfy the Low Frequency Induction (LFI) Level 1 (Conservative) compliance of AS/NZS 4853 – 2012 Table 4.2 & 4.4 which specifies maximum acceptable power line to pipeline exposure length.

Per AS/NZS 4853 – 2012 the pipeline expose length (average separation for the parallel section) under LFI conditions shall be less than the values given in **Table 9** below.

**Table 9 Exposure Length for Pipeline Subject to LFI from Power Lines (Level 1 Assessment)**

Power line to pipeline separation (m)	Exposure Length (m) – Note 1		
	Distribution Power Line ( $\geq 11$ kV) – 100 $\Omega$ .m	Power Line	Transmission Power Line ( $\geq 66$ kV) – 100 $\Omega$ .m
5	180		95
10	210		110
20	240		127
50	310		165
100	400		210
200	550		290
500	950		500

**Note 1:** Without soil resistivity data, assessments are to be completed assuming 100  $\Omega$ .m. If soil resistivity data is available refer to AS/NZS 4853 – 2012.

Where AS/NZS 4853 Level 1 EPR or LFI requirements cannot be achieved a Level 2 and/or 3 assessment will be required.

The third party must provide to APA detailed plans of any source(s) of earthing and/ or electrical effects proposed to be located in the vicinity of steel gas assets, with an assessment report compliant with AS/NZS 4853 Electrical Hazards on Metallic Pipelines. This assessment report is to determine any effects to existing cathodic protection or induced voltage mitigation systems from these types of installations. The third party must address any relevant requirements and any recommendations and/or actions must be implemented to the satisfaction of APA Networks. All cost association with the study, and implementing its recommendations and/ or actions are to be borne by the third party. The third party must also complete validation testing upon completion of construction and provide all findings/ reports to APA Networks.

Hazards which may arise due to electrical systems located in the vicinity of steel gas assets include the following:

- Accidental contact between gas assets and electrical systems;
- Capacitive coupling;
- Conductive coupling;
- Electromagnetic induction;
- Low Frequency Induction (LFI);
- Earth Potential Rise (EPR), including due to fault current or lightning discharge; and,
- Adverse cathodic protection interference in excess of those allowed under AS 2832.1 or relevant state regulations

## 4.7 Temporary and Permanent Vehicle Crossings

Vehicle crossings over existing gas assets are limited to light vehicles (Gross Vehicle Mass not greater than 4.5 tonnes unless advised otherwise by APA Networks in writing) on unsealed surfaces or Heavy Vehicles (compliant General Access Vehicles) on established road pavements.

Any proposed new crossings must be assessed and authorised in writing by APA Networks.

A maximum surface pressure of 400 kPa is allowable directly above buried gas assets. However, any surface pressure exceeding this limit or where cover over the gas asset has been reduced from **Table 6** will require an APA Engineering Assessment and approval.

Where soil conditions exhibit poor compaction and load bearing characteristics, such as wet soil conditions, equipment is not permitted to cross the gas asset irrespective of weight without establishing a stable sealed surface or road plates.

Crane footings or bog mats must not be placed where the angle of repose can influence an existing gas asset without express written approval by APA. Where the existing gas asset is within the angle of response, the maximum surface pressure due to the crane must be provided.

## **5 PART 3 - CONSTRUCTION AND LAND USE REQUIREMENTS**

Extreme care should be exercised at all times when working around existing gas assets, as repair works will be fully chargeable and may result in delays to any works. Refer to the duty of care outlined in **Section 1.4** and the requirements of this section when selecting construction methods.

### **5.1 Land Use Change**

Where works proposed by a third party may result in a change in land use within the Measurement Length (as defined in AS/NZS 2885.6 for Pipelines – Gas and Liquid Petroleum) of transmission assets, such works may also be subject to formal approval requirements through APA Networks and applicable local and state government planning processes.

This may also require a Safety Management Study (SMS) report be completed and approved by APA Networks. This SMS report is generated from an SMS workshop involving an independent SMS facilitator, third party and APA Networks. APA Networks is the owner of the SMS report and any resulting recommendation/ actions must be implemented to the satisfaction of APA Networks prior to the commencement of any physical works.

Certain categories of development, such as Sensitive Use Locations (refer to **Table 14 Glossary of Terms and Abbreviations**), are not appropriate to be located with the Measurement Length. In certain circumstances, the otherwise unacceptable risks associated with such developments may be alleviated with the aid of installing protective slabbing over the transmission pipeline or undertaking other protection and mitigation measures.

Sensitive Use Locations near transmission pipelines are designated under AS/NZS 2885.6 and identify land where the consequences of a Failure Event may be increased because it is developed for use by sectors of the community who may be unable to protect themselves from the consequences of a pipeline Failure Event.

Sensitive uses are defined as follows;

- Schools, which includes colleges
- Hospitals and aged care facilities such as nursing homes, elderly people's homes
- Prisons and jails
- Sheltered housing
- Buildings with five or more stories
- Large community and leisure facilities, large open air gatherings
- Day care facilities
- Other potentially difficult to evacuate facilities
- Other structures as defined by relevant local councils.

For further information regarding the SMS process, refer to APA Networks Encroachment and Land Use Change SMS Trigger Procedure, **400-PR-L-0003**.

### **5.2 Permits and Site Watch**

Transmission pressure assets and critical distribution pressure assets, must have a permit issued prior to proposed works in the vicinity of the existing assets, including any proving activities. Following the issue of a permit, a site watch inspector may be required to verify that the activities are carried out appropriately.

Other distribution pressure assets not considered critical will only require site watch as determined by APA Networks.

Where a permit is required, the response provided to the BYDA enquiry will include the relevant forms and process to be followed for submitting a permit request.

While BYDA recommends completing the request two business days prior to undertaking works, this is to ensure that the location information is obtained. This may not allow sufficient time for APA Networks to supply site watch. Further delays may be experienced if the proposed works are significantly complicated, do not meet the requirements of this document or if insufficient information is provided.

**It is an offence in all jurisdictions to undertake activities in the vicinity of transmission pipelines without prior authorisation by the operator.**

### **5.3 Coating Surveys and Leakage Surveys**

Where proposed works have potential to indirectly damage pipe coating (i.e. due to compaction) or result in a leak of the gas asset (e.g. vibration of cast iron pipes), additional monitoring activities such as Direct Current Voltage Gradient (**DCVG**) or leakage surveys may be required.

If required, chargeable DCVG surveys will be conducted prior to works to establish any existing coating faults which exist on the gas asset. A subsequent DCVG survey will be conducted at the conclusion of works, and where new faults have developed on the gas asset, repairs shall be made with costs charged to the works owner. Surveys can be conducted prior to finalising road surfaces to avoid costly repairs.

A similar chargeable survey program can be applied where leakage surveys are required. However, additional surveys may be necessary throughout works to ensure work crews do not operate in a gaseous environment once leaks are caused.

### **5.4 Pipeline Repairs, Recoating and Slabbing**

Buried steel assets operated by APA Networks are coated to provide protection from corrosion.

Where the surface conditions above a buried steel pipe are changed which may limit future access to the existing gas asset an assessment of the coating condition will likely be triggered.

The requirement for pipeline recoating is assessed by APA Networks on a case by case basis, based on the proposed works, but will generally be dependent on the following:

- The asset class;
- The existing coating type, age and condition;
- Increase in loading that can bring forward any pipeline anomalies; and,
- Changes limiting access to the existing asset(s), such as the installation of slabbing, road pavement, culverts, embankment ramps or any other feature.

A chargeable coating survey carried out in accordance with **Section 5.3** may be required to assess the condition of the existing gas asset coating.

Recoating and/ or associated slabbing works over any gas asset will be determined by APA Networks Engineering Assessments and any applicable risk assessments (Safety Management Study or Formal Safety Assessment).

Pipeline repairs, recoating and slabbing that form part of any third party commercial agreement will be charged to the third party.

The requirement for, and the extent of, slabbing over any APA Networks operated asset will be determined by APA at its sole discretion and may depend on factors other than only changes in depth of cover discussed in **Section 4.4**. Slabbing may be required for the following reasons:

- Removable protective slab to provide protection from third party mechanical excavation;
- Bridging slab to provide protection from external loadings e.g. insufficient depth of cover combined with vehicle traffic.

Slabbing must be installed with adequate separation from the pipe, which may impact the undisturbed cover requirement, and cannot be installed directly underneath road pavement or at surface level.

Any bridging slab designs prepared by a third party must be accompanied by certification from the registered practising structural engineer (Registered Professional Engineer Queensland (**RPEQ**) required for works in Queensland, and so on as required for other States and Territories) confirming that the design is adequate to prevent pipeline loading.

## **5.5 Exposure of Buried Gas Assets**

### **5.5.1 General**

Excavation works covers Non-Destructive Digging (**NDD**) and mechanical excavation. All such excavations must be completed in accordance with APA's direction.

The Third Party or its Contractor can perform exposure works on APA Networks operated assets via NDD using vacuum excavation and subsequent mechanical excavation works under the following conditions:

- **A current BYDA request is available for the works.**
- An approved Authority to Work Permit (**ATWP**) is issued for works near transmission pipelines or critical mains.
- APA Site Watch Officer is present for works near transmission pipelines or critical mains as outlined on the ATWP.
- The Third Party (or its Contractor) shall ensure they have their own SWMS, Risk Assessment, Environmental Management Plan, Tool Box Talk, Traffic Management and Pre-Start in line with their own corporate policy in place prior to works commencing.
- All underground assets have been identified by surface marking where within or close to the excavation area prior to proceeding with planned proving works (i.e. hand or NDD (e.g. Hydro-Vacuum Excavation). Any non-recorded assets should be identified prior to breaking ground (e.g. excavation or cutting).
- A check for gas leaks has been conducted prior to the commencement of work.
- If the mechanical excavation operator cannot see the spotter (where applicable, APA Site Watch Officer), he or she must stop moving immediately and not resume movement until contact has been established. Spotters must be aware of their surroundings and should never walk into the path of a vehicle, moving equipment or a swinging load. They need to scan the ground to become aware of any trip or fall hazards.
- If excavations are greater than 1.5 m or ground conditions are considered unstable benching/ battering/ shoring must be utilised. Additionally, appropriate ladders/ ramps or steps must be utilised to ensure safe access and egress.
- **Under no circumstances is mechanical equipment to be used within 300 mm of any gas asset.**

### **5.5.2 Physically Proving Gas Assets**

Prior to mechanical excavation of the gas assets, the asset shall be physically proven by NDD or through the use of hand excavation. The method used will vary based on the criticality of the asset. The requirements in **Section 5.5.1** shall be implemented prior to physically proving the gas asset.

#### **Technique 1 – Vacuum Excavation (Critical and Non-Critical Gas Assets)**

A vacuum truck can be used to prove and expose the gas asset. Please ensure the requirements detailed in **Section 5.5.3** are adhered to.

#### **Technique 2 – Hand Excavation (Critical and Non-Critical Gas Assets)**

If the anticipated depth of cover of the gas asset is less than 1m (measured from the top of pipe) then hand excavation shall be used to expose the gas asset. The use of round edge shovels should be used to avoid damage to the pipe or coating. In the event that the anticipated depth of cover of the gas asset is greater than 1m then mechanical excavation can be undertaken in accordance with the requirements of **Section 5.5.4** but must stop when within 1m of the gas asset (i.e. 1.3m anticipated depth means that 300 mm of cover can be removed by mechanical excavation and the



remainder by hand excavation as described above. The anticipated depth shall be based on the shallowest result from BYDA or pipe locator.

### **Technique 3 – Hand + Excavation (Non-Critical Gas Assets ONLY)**

If the gas asset is deemed non-critical then a combination of hand digging and excavation can be used. This technique requires the third party to hand excavate 300 mm then mechanically excavate the first 150 mm. In this technique the hand excavation shall always lead the mechanical excavation by 150 mm. Once within 300 mm of the gas asset then only hand excavation is allowed.

### **5.5.3 Hydro-Vacuum Excavation**

Where hydro-vacuum excavation is used in the vicinity or to expose existing gas assets, the following conditions must be applied:

- Ensure the general requirements in **Section 5.5.1** are adhered to prior to the works commencing.
- Root cutting heads shall not be used at any time.
- When locating pipelines and mains, a maximum water pressure of 2500 PSI (17200 kPa) may be used to a depth no greater than 450 mm. Below this depth, the maximum water pressure shall be set in accordance with **Table 10** for the asset type in the vicinity.
- When locating customer offtakes (services), a maximum water pressure of 2500 PSI (17200 kPa) may be used to a depth no greater than 300 mm. Below this depth, the maximum water pressure shall be set in accordance with **Table 10** for the asset type in the vicinity.
- Where air is used in place of water the air pressure shall not exceed 175 PSI (1200 kPa).
- A minimum distance of 200 mm shall be maintained between the nozzle tip and subsoil and vertical movements avoided (i.e. nozzle shall not touch or be inserted into soil).
- The wand shall never remain motionless during excavation. Aiming directly at the gas asset shall be avoided at all times.
- NDD vacuum equipment must not come into contact (impact) with the pipe or coating.
- Once a gas asset has been exposed via hydro-vacuum methods, a visual check must be undertaken to ensure no damage has occurred to the pipe or its coating. Damage caused to the pipe coating by the third party will be chargeable.
- A dead man trigger or similar, shall be installed and used on the wand.
- If conduits are to be installed for identification of the gas assets location the conduit shall be offset to one side and recorded or a flexible conduit installed over the gas asset. The placement of PVC pipes directly on the gas asset may cause damage to the pipe coating and require repair at the contractor's expense.
- Vacuum excavated holes shall be cleaned of any rocks and debris and backfilled with a minimum 300 mm of sand.

Personnel operating NDD equipment shall monitor ground conditions to determine and adjust for the lowest water pressure setting and vacuum used to adequately expose the gas asset. The objective shall be to use the lowest possible pressure and vacuum required to adequately excavate in order to minimise risk of coating and/or pipe damage. **Table 10** provides the maximum water pressure to be used for various pipe and coating types.

**Table 10 Maximum Water Pressure for Hydro-Vacuum Excavation**

Pipe / Coating Type		Max. Water Pressure (PSI)	Pipe / Coating Type	Max. Water Pressure (PSI)
Steel	Coal Tar Enamel Coated	1,000	<b>Steel – Mummified fittings</b> (e.g. valves, flanges)	Not Permitted
	Polyethylene Tape Coated	1,000	<b>Cast Iron</b>	1,000
	Polyethylene Coated	2,000	<b>Polyethylene</b>	2,000
	Trilaminate Coated	2,000	<b>Nylon or PVC</b>	1,500
	FBE or HBE Coated	2,000	<b>Unknown Material or Steel Pipe Coating</b>	1,000
	Uncoated	2,500		

**5.5.4 Mechanical Excavation**

Prior to commencing any excavation works the general requirements in **Section 5.5.1** must be adhered to.

Where works are to be carried out within 3 m of the gas alignment and to 1 m of the known gas main depth, the contractor is required to pothole and expose the gas asset as outlined in **Section 5.5.5**.

Prior to the mechanical excavation commencing ensure the excavator is in working order and all pre-start equipment checks are completed.

Excavators with general purpose buckets (e.g. mud bucket, general purpose teeth) up to 30 tonnes are permitted to conduct mechanical excavations in the vicinity of existing APA gas assets in accordance with APA requirements. Any variation of excavator size or bucket type will require assessment and approval by APA Networks. Buckets with any type of tiger or penetration teeth are not permitted unless explicitly approved by APA Networks.

**Critical Gas Assets**

No mechanical equipment shall be used within 1 m of the potholed depth of the critical gas asset, except under explicit on site direction from an APA representative (i.e. APA Site Watch).

**Under no circumstances is mechanical equipment to be used within 300 mm of any gas asset.**

Once the gas asset has been positively proven, as outlined in **Section 5.5.2**, mechanical excavations can commence at a minimum of 300 mm offset from the outer edge of the pipe. The third party shall not mechanical excavate directly over a critical gas asset, with hand excavation only directly over the alignment or to expose the asset.

**Figure 3 Gas Asset Side Excavation Method**

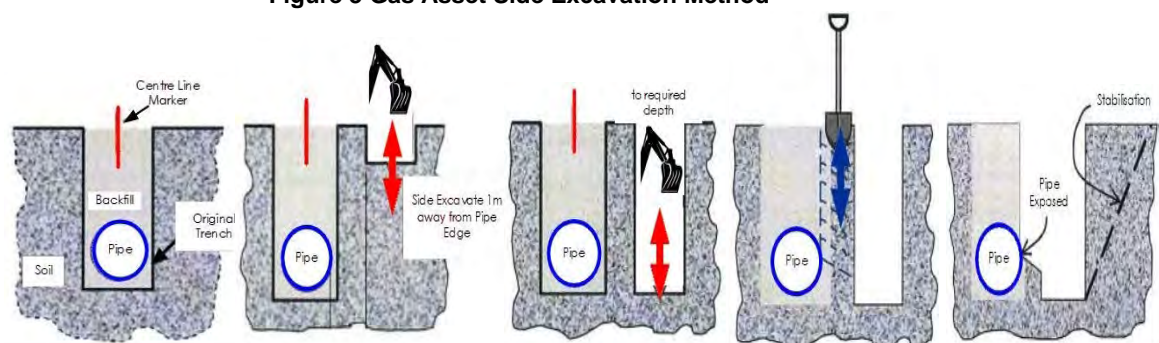

### Non-Critical Gas Assets

Mechanical excavation is permitted directly over the top of non-critical gas assets however **under no circumstances is mechanical excavation equipment to be used within 300 mm of any gas asset.** If the third party is in doubt with regards to the criticality of the gas asset, then the excavation method outlined for critical gas assets shall be used.

Prior to the mechanical excavation commencing, the asset shall be physically proved as outlined in **Section 5.5.2**. Once the depth has been physically proven the third party can proceed with excavating around the gas asset until within 300 mm. From this point hand excavation or NDD is required.

#### 5.5.6 Protection During Exposure

Additional protection measures are required where an exposed gas asset may be subject to impact from construction activities, sagging of exposed pipe and trench instability. Any works requiring exposure and protection of the gas asset should have an accompanying methodology and approval by APA Networks.

Physical protection (e.g. structural steel protection, sandbags, wrapped with split PVC pipe) should be installed around the exposed gas asset when exposed, particularly when new infrastructure is planned to be installed crossing below the gas asset. If the gas asset is to be exposed for longer than one day or otherwise left unattended, suitable barricades, security fencing and/ or steel plates will be required to provide protection from vehicles, dropped objects (such as construction materials) or vandalism.

Unsupported exposed pipe lengths require protection from sagging by using suitable supports such as sandbags or slings. Where slings or other support types come into contact with the gas asset, protection methods must be employed (e.g. wrapped with split PVC pipe) to prevent damage to the existing pipe or coating. Exposed unsupported joints must also be identified and supported during works. The maximum allowable length of exposed pipe without support is provided in **Table 11**.

**Table 11 Maximum Unsupported Lengths of Exposed Pipe**

Gas Asset Diameter (mm)	Steel Maximum Unsupported Length (mm)	Polyethylene Maximum Unsupported Length (mm)	Other Material Maximum Unsupported Length (mm)
≤20	2,000	1,500	1,500 <b>(Note 1)</b>
>20 & ≤63	2,800	2,000	
>63 & ≤100	3,600	3,000	
>100 & ≤150	4,200		
>150 & ≤250	5,000		
>250	5,700		

**Note 1:** Particular care should be taken for other materials include cast iron, PVC or nylon due to the unpredictable nature of the joints.

Additional protection and support during trench or bell-hole excavation works to minimise ground instability may also be necessary to protect the integrity of existing gas assets during exposure works. Trenches are to be inspected prior to commencing works each day and monitored by the onsite party responsible for the excavation. APA shall be notified of any condition likely to affect the stability of trench.

Any deep excavations, within 3 m of a gas asset, shall be designed and constructed such that the effects of subsidence, collapse or extreme weather will not affect the gas asset. Any such excavations prepared by a third party must be accompanied by certification from a registered practising engineer (RPEQ required for works in Queensland, and so on as required for other States and Territories) confirming that the design is adequate to protect the gas asset.

### 5.5.7 Backfill and Reinstatement

Prior to backfilling, a minimum of 150 mm of bedding sand must be placed around all gas assets. Bedding sand shall be in accordance with APA specification **400-SP-L-0002**, which can be provided to third parties upon request. The bedding must be compacted in accordance with **Section 5.10**, including suitable compaction and backfill of the underside of the gas asset to prevent any further vertical movement during subsequent layers above the asset. APA may require geo-fabric installation between different trench reinstatement products to prevent sand migration in which nonwoven fabric is required and needs to extend 1000 mm past either side of the utility crossing.

The bedding material shall be clean, free from all sharp objects, sandbags, clay material, vegetable matter, building debris and disused road paving material to the specification provided by APA. Recycled bedding material and stabilised sand must not be used unless explicitly approved by APA.

The remainder of the excavation shall be backfilled and compacted in accordance with **Section 5.10**, at maximum increments of 300 mm to a density which is similar to the surrounding sub-grade material. Only clean fill material shall be used, preferably the same as the natural soil in the area, and free from ash, weeds and pest plants, salt or any chemicals which could harm the gas assets. Where required, concrete slabbing shall be installed in accordance with **Section 5.4**.

In all circumstances gas warning tape / marker board shall be installed in accordance with the following requirements:

- Gas warning tape installed at 300 mm below finished surface level.
- Gas marker board installed 300 mm above the top of the pipe.

Note, where gas warning tape cannot be installed 300 mm below the finished surface level due to road pavement box out, marker board is to be installed 50 mm below the box out work zone.

In situations where a physical protection slab or bridging slab has been utilised an additional layer of gas marker board must be installed 50 mm above the slabbing.

The excavated area is to be reinstated to the original condition or as approved by APA and the relevant local council, road authority or landowner as applicable. Any marker signs removed during excavation works must also be reinstated in original positions. Additional marker signs may be required at new infrastructure crossings as directed by APA.

## 5.6 Trenchless Excavation

Trenchless excavation covers horizontal directional drilling (**HDD**), boring, pipe bursting and tunnelling. These activities are considered high risk that require additional controls to prevent damage to existing gas assets. This includes proving the existing gas asset location and depth for all horizontal bores, as well as providing a witness trench to verify that the bore will pass the asset with sufficient separation.

A witness trench must be used in addition to live electronic tracking of the bore head. The witness trench must be prepared to the specification provided in **Table 12**. The progressive measurement of the length of the bore must also be made and plotted along its proposed direction to ensure the bore head has not missed the witness trench. The bore head must be exposed in the witness trench, when the crossing is above the existing gas asset.

For all assets installed via trenchless excavation a vertical separation aligning with the maximum borehole diameter (e.g. reamed diameter) shall be demonstrated. For transmission pressure and distribution pressure assets this vertical separation distance is 1000 mm and 600 mm, respectively.

If the works run parallel to a transmission pressure or critical gas assets a minimum separation distance of 3 m must be maintained. For non-critical gas assets, the minimum separation distance of 1 m must be maintained. For works running parallel to gas assets, proving of the actual location of the gas asset must occur every 4 m.

**Note:** It is expected that HDD operators working near gas assets hold the national competency RIICCM202 – Identify, location and protect underground service.

**Table 12 Minimum Witness Trench Dimensions**

Crossing Type	Witness Trench Depth	Witness Trench Dimensions
Crossing Above Existing Gas Asset	To bottom (invert) of gas asset	Witness trench shall be 1000 mm to 2000 mm in front of the gas asset on the approach side. Witness trench shall be min. 1500 mm long and 300 mm wide centred on bore centre line.
Crossing Below Existing Gas Asset	To bottom (invert) of gas asset plus 500 mm	

Dispensation may be considered where detailed long sections are provided for assessment by APA and where depths of existing gas assets or separation to the bore are greater than 2500 mm.

Pipe bursting is not permitted within 1000 mm of an existing gas asset.

### 5.7 Piles, Piers or Poles

No piling such as pile-driving, sheet-piling or hammer-piling is permitted within 15 m of an existing gas asset unless explicit consent has been provided by APA. In all instances, vertical bored (augured) piles, piers or poles are preferred.

Where installation of piles, piers or poles are proposed between 500 mm and 1000 mm clearance from a gas asset (distribution and transmission pressures, respectively), the area directly below the proposed pile, pier or post location must be excavated to a level equivalent to the bottom (invert) of the existing gas asset, and works started from that depth.

**Note:** Proving of the gas asset must be completed in accordance with the requirements set out in **Section 5.5.2** prior to the commencement of any works.

Temporary steel plates may also be installed between the gas asset and the proposed pile, pier or post used for vertical bore methods within this clearance to provide extra protection.

**Note:** Direct vibration monitoring on the gas main may be required depending upon the installation method utilised. Refer to **Section 5.9** for APA Networks vibration limits.

### 5.8 Hot Works for Construction Activities

Typical hot works include grinding, welding, thermal or oxygen cutting or heating, and other related heat producing or spark-producing operations. Heat sources or hot works must not impact gas assets, taking into consideration that the ground or adjacent structures may also be capable of transmitting heat.

In order to safely undertake hot works, response procedures in the event of fire or flammable gas detection must be prepared and monitoring for flammable gases must be undertaken during works.

APA must approve any hot works where there is less than 300 mm ground cover to buried gas assets, or within 5,000 mm of any exposed gas assets (including any pits or valve covers). A heat shield or barrier may be required to provide protection if it cannot be demonstrated that works can be undertaken without impacting the gas asset.

### 5.9 Vibration Limits

Significant vibration may arise from activities such as blasting, piling, tunnelling and HDD/boring.

To avoid damage to existing APA Networks operated pipes and coatings, the following vibration limits must not be exceeded at any point on the pipe:

- a) For cast iron mains: 5 mm/s maximum Peak Particle Velocity (**PPV**) measured on the pipe.
- b) For steel pipe with a coal tar enamel (**CTE**) coating or with poor coating health: 10 mm/s maximum PPV measured on the pipe.
- c) For non-coal tar enamel pipe coatings and other pipe materials (i.e. steel, PE, PVC or Nylon): 20 mm/s maximum PPV measured on the pipe.

d) For blasting, the above vibration limits can be increased if supported by calculations in accordance with Design Guidelines for Buried Steel Pipeline – American Lifelines Alliance American Society of Civil Engineers (**ASCE**) and approved in writing by an APA Networks Integrity Engineer.

**Note:** Cast iron mains are particularly susceptible to damage by vibration. The PPV limit may not prevent leaks from cast iron and may require additional gas leakage survey activities during works in accordance with **Section 5.3**.

For vibration monitoring adopt an alarm at 80% of the acceptable PPV value and when the alarm is activated, the work must stop and be re-assessed. Short incursions up to 100% are acceptable, for sustained periods of vibration longer than 5 minutes, works must be stopped.

The zone of influence for vibration assessment undertaken by the third party is shown below;

- For compaction, refer to **Table 13**.
- For trenchless excavation (HDD/ boring), refer to **Section 5.6**.
- For piling refer to **Section 5.7**.
- For blasting refer to **Section 5.11**.

## 5.10 Compaction Limits

Compaction activities such as establishing a base course for a road pavement may result in damage to the pipes and coatings of existing gas assets. Compaction limits in the vicinity of existing gas assets are summarised in **Table 13**.

**Table 13 Maximum Compaction Limits**

Horizontal Separation (m)	Minimum Cover to Top of Gas Asset (mm)	Compaction Limits
≤3 (Note 1)	300	Small handheld compactor only
	500	Large handheld compactor Maximum 4 tonne tandem drum static roller
	750	Maximum 8 tonne tandem drum static roller
	1200	Maximum 10 tonne tandem drum static roller subject to APA approval
>3 & ≤10	All	Maximum 8 tonne tandem drum vibrating roller
>10 & ≤15	All	Maximum 10 tonne tandem drum vibrating roller
>15	All	Any compaction method

**Note 1:** Compaction within 3 m of gas assets is limited to static rollers. If vibration compaction is necessary a robust vibration assessment and construction methodology signed off by an RPEQ for works in Queensland, and so on as required for other States and Territories, will need to be produced by the third party for review and approval by an APA Networks Integrity Engineer.

## 5.11 Blasting / Seismic Survey / Explosives

Blasting, seismic survey or the use of explosives is not permitted within 100 m of a gas asset unless explicit approval is provided by APA Networks. The size and quantity of the explosives to be used will determine how close to the pipeline blasting will be permitted. In all cases, blasting methods must be arranged to limit ground vibrations so that the peak particle velocity does not exceed acceptable limits. At no stages will blasting be permitted within 3 m of the pipeline.

### 5.12 Suspended Materials above Gas Assets and No Go Zones for Cranes

Where gas assets are exposed, no cranes, excavators or backhoes are permitted to carry or suspend materials directly over or across a gas asset without an APA Networks approved lifting plan and SWMS.

Outriggers must be set up outside a 3 m radius from gas assets unless otherwise approved by APA Networks in writing.

### 5.13 Temporary Materials

In all instances it is preferred that temporary materials (e.g. soil, shipping containers) are not stored on top of transmission pressure and critical gas assets. Temporary material must not restrict access and should be placed at least 1,500 mm from the alignment of these assets unless otherwise approved by APA Networks.

## 6 PART 4 - ALTERATION OF EXISTING GAS ASSETS

Where the proposed third party works do not comply with the requirements of this document, and adequate additional controls or a specialised engineering solutions cannot be developed, alteration of the existing gas assets will be required.

Gas asset alterations will only be undertaken under a Recoverable Works Agreement (**RWA**) appropriate to the scope and extent of the works required.

An Early Works Agreement (**EWA**) may also be required where works are proposed which require proving, engineering design activities or purchase of long lead items. This will allow for completion of these items prior to execution of a RWA and avoid delaying works.

If either or both these agreements are required, then APA Networks will enter negotiations with the relevant third party and any costs will be payable by that third party.

## 7 GLOSSARY OF TERMS AND ABBREVIATIONS

**Table 14** Glossary of Terms and Abbreviations

Term/ Abbreviation	Meaning
AGN	Australian Gas Networks
APA	Each entity that forms part of the APA Group
APA Engineering Assessment	Covers technical assessments which may involve field integrity assessments that may or may not include the use of specialist Consultants managed by APA.
APA Networks Operated Assets	APA Networks acts as the asset operator on behalf of entities Australian Gas Networks (AGN), Allgas, APA, Origin and Queensland Nitrates (QNP) and operates in New South Wales, Northern Territory, Queensland, South Australia and Victoria.
APA Permit Issuing Officer	The APA Permit Issuing Officer is responsible for opening the Permit To Work, validating APA Networks assets have been located and being the Site Watch for works within the gas Easement or Protected Zone.
AS	Australian Standard
ASCE	American Society of Civil Engineers
ATWP	Authority to Work Permit
CTE	Coal Tar Enamel
Damage	Physical damage to and interference with APA's assets. Damage includes reducing design life, coating damage, dents, scratches, rupture, cutting of cathodic protection cables. Damage can also include potential impacts that APA pipelines can have on third party assets.
BYDA	Before You Dig Australia (previously known as Dial Before You Dig (DBYD))
DCVG	Direct Current Voltage Gradient
Depth of Cover	Vertical distance from the existing natural ground surface to the top of the buried gas asset
EPR	Earth Potential Rise
ESV	Energy Safe Victoria
EWA	Early Works Agreement



Excavation	Excavation refers to manual digging or mechanised digging operation with plant or equipment which involves trenching and trenchless excavation. Trenchless excavation covers boring, Horizontal Directional Drilling (HDD), pipe bursting and tunnelling.
FBE	Fusion Bonded Epoxy
GIS	Geographic Information System
HBE	High Build Epoxy
HDD	Horizontal Directional Drilling
Hot Works	Hot works are defined as grinding, welding, thermal or oxygen cutting or heating, and other related heat-producing or spark-producing operations. Heat sources or hot works must not impact pipelines, taking into consideration that the ground or adjacent structures may also be capable of transmitting heat.
LFI	Low Frequency Induction
LPG	Liquefied Petroleum Gas
MAOP	Maximum Allowable Operating Pressure
Measurement Length	<p>The maximum length of pipeline route which presents an extended source of hazard on the basis that an event of failure could affect any part of the development or specific location relevant to the development.</p> <p>The maximum length corresponds to the heat radiation hazard associated with a 4.7 kW/m<sup>2</sup> heat radiation contour for an ignited full bore rupture calculated in accordance with AS/NZS 2885.6. If the pipeline is designed as a no rupture pipe, then the measurement length corresponds to a credible leak size.</p>
NDD	Non-Destructive Digging (NDD) refers to either hand digging or Non-Destructive Pot Holing using a vacuum pipe connected to a vacuum truck with either a water lance or air lance. Hydro-Vacuum Excavation consists of a water lance and vacuum truck and is used to physically prove existing assets.
OHEW	Overhead Earth Wire
PE	Polyethylene
Pipe Bursting	Pipe bursting refers to a pipe being inserted to a larger pipe that results in the larger pipe being damaged. For an example of pipe bursting, refer to the following You-Tube video: <a href="https://www.youtube.com/watch?v=HX5beh0ubGY">https://www.youtube.com/watch?v=HX5beh0ubGY</a>
Pipeline Easement	The pipeline area shown on a survey plan and referenced on the property title.
Predominate Building Line	The expected predominate building line relates to the façade of the building, not necessarily the property boundary.
Protected Zone	A Protected Zone is an area extending both horizontally and longitudinally along a gas asset. It is the area where loads and/or any hot works may potentially cause damage to the gas asset.

	The Protected Zone refers to works near APA Networks gas assets or works within the vicinity of the gas assets that may cause an unacceptable risk to the asset in accordance with Table 2 Minimum Clearances or Table 3 Minimum Clearances for Construction Works and Land Use Activities
PTW	Permit to Work
PPV	Peak Particle Velocity
PVC	Polyvinyl Chloride
QNP	Queensland Nitrates Plant
RPEQ	Registered Profession Engineer Queensland
RWA	Recoverable Works Agreement
Sensitive Use Locations	<p>This is designated as Class “S” as per AS/NZS 2885.6 Pipelines - Gas and liquid petroleum - Pipeline safety management and refers to the sub location class.</p> <p>Sensitive Use Location Class (S) identifies land where the consequences of a FAILURE EVENT may be increased because it is developed for use by sectors of the community who may be unable to protect themselves from the consequences of a pipeline FAILURE EVENT.</p> <p>Sensitive uses are defined as follows:</p> <ul style="list-style-type: none"> <li>• Schools which includes colleges</li> <li>• Hospitals</li> <li>• Aged care facilities such as nursing homes, elderly people’s homes</li> <li>• Prisons and jails</li> <li>• Convalescent homes</li> <li>• Sheltered housing</li> <li>• Buildings with five or more stories</li> <li>• Large community and leisure facilities, large open air gatherings</li> <li>• Day care facilities</li> <li>• Other potentially difficult to evacuate facilities</li> <li>• Other structures as defined by relevant local councils.</li> </ul> <p>The Sensitive Use Location Class “S” must be assigned to any section of a gas transmission pipeline where there is a sensitive development within the applicable Measurement Length.</p>

Site Watch	<p>An APA Site Watch representative can be the Permit Issuing Officer for excavation work within a gas Easement or Protected Zone and is referred to as the primary spotter for excavation works.</p> <p>The secondary spotter is provided by the Contractor.</p> <p>The primary spotter has the ultimate decision regarding works within the gas Easement or Protected Zone which includes the method of excavation, starting and stopping excavation work.</p> <p>The APA Site Watch representative is the nominated competent person responsible for the following;</p> <ul style="list-style-type: none"> <li>• Making themselves highly visible and everyone on the job site should be aware of the Site Watch's role;</li> <li>• Communication to personnel operating mobile plant and equipment ensuring minimum clearance to above and below ground assets is maintained and the construction methodology is adhered to and complies with APA Networks requirements.</li> </ul> <p>Ensuring personnel do not encroach within the swing radius of the operating machinery.</p>
SMS	Safety Management Study
SMWS	Safe Work Method Statement used by APA or Contractors to execute field work. The risks and associated control measures risk assessments should be transferred to SWMS.
SRZ	Structural Root Zone
Structures	Structures refer to third party structures which includes, but is not limited to; temporary or permanent buildings, walls, canopies, footings, pile caps or retaining walls
Third Party	The person or entity and their agents or Contractors that propose to undertake work near APA assets.
Third Party Assets	Third Party Assets include roads, utilities and structures.
Third Party Excavation	Third Party Excavation which is <b>not</b> associated with APA (e.g. road works, utility installation, private development, fencing).
Third Party Works Classification	<p>The Third Party Work Classification as shown in <b>Section 3.3</b> covers the following three work classifications:</p> <ol style="list-style-type: none"> <li>1. No Impact to gas assets</li> <li>2. No Objection Under Conditions</li> <li>3. Enquiry Escalated for Alteration</li> </ol>
Transmission Pipeline	Gas transmission pipeline which includes all associated equipment such as cathodic protection, earthing grid, instrumentation and electrical cables.
Utilities	Includes water, wastewater, drainage, telecommunications cables, power poles and cables owned by individuals or organisations other than APA Networks.
Voltage	<p>Difference of potential normally between conductors or between conductors and earth as follows:</p> <ol style="list-style-type: none"> <li>a) Extra-low voltage – Not exceeding 50V a.c. or 120 V ripple-free d.c.</li> <li>b) Low voltage – Exceeding extra-low voltage, but not exceeding 1000 V a.c. or 1500 V d.c.</li> </ol>



	c) High voltage – Exceeding low voltage.
Works	The development of any type of buildings, structures and other obstructions (including residential buildings, pools, sheds, carports, major developments, transport infrastructure, services, stockpiles, trees), and any work that causes changes to the ground (including movement of heavy vehicles, blasting, tunnelling, pile driving, ground compaction, earthworks, open and trenchless excavations)

## 8 DOCUMENT REFERENCES

**Table 15 Document References**

<b>External Standards</b>	
API RP 1102	Steel Pipeline Crossing Railroads and Highways
AS 2832.1	Cathodic protection of metals: Pipes and cables
AS 2885.0	Pipelines – Gas and liquid petroleum: General requirements
AS/NZS 2885.1	Pipelines – Gas and liquid petroleum: Design and Construction
AS/NZS 2885.2	Pipelines – Gas and liquid petroleum: Welding
AS 2885.3	Pipelines – Gas and liquid petroleum: Operations and Maintenance
AS 2885.5	Pipelines – Gas and liquid petroleum: Field Pressure Testing
AS/NZS 2885.6	Pipelines – Gas and liquid petroleum: Pipeline safety management
AS/NZS 4645.1	Gas Distribution Networks - Network Management
AS/NZS 4645.2	Gas Distribution Networks - Steel Pipe Systems
AS/NZS 4645.3	Gas Distribution Networks - Plastics Pipe Systems
AS 4799	Installation of Underground Utility Services and Pipelines Within Railway Boundaries
AS 4827.1	Coating defect surveys for buried pipelines Part 1: Direct current voltage gradient (DCVG)
AS/NZS 4853	Electrical Hazards on Metallic Pipelines
AS 4970	Protection of trees on development sites
<b>Standard Policies, Procedures, Specifications, Guidelines, Forms and Templates</b>	
400-SP-L-0002	Networks Bedding Material Specification
400-PR-L-0003	Encroachment and Land Use Change SMS Trigger Procedure

## APPENDIX A GENERAL DBYD RESPONSE PROCESS

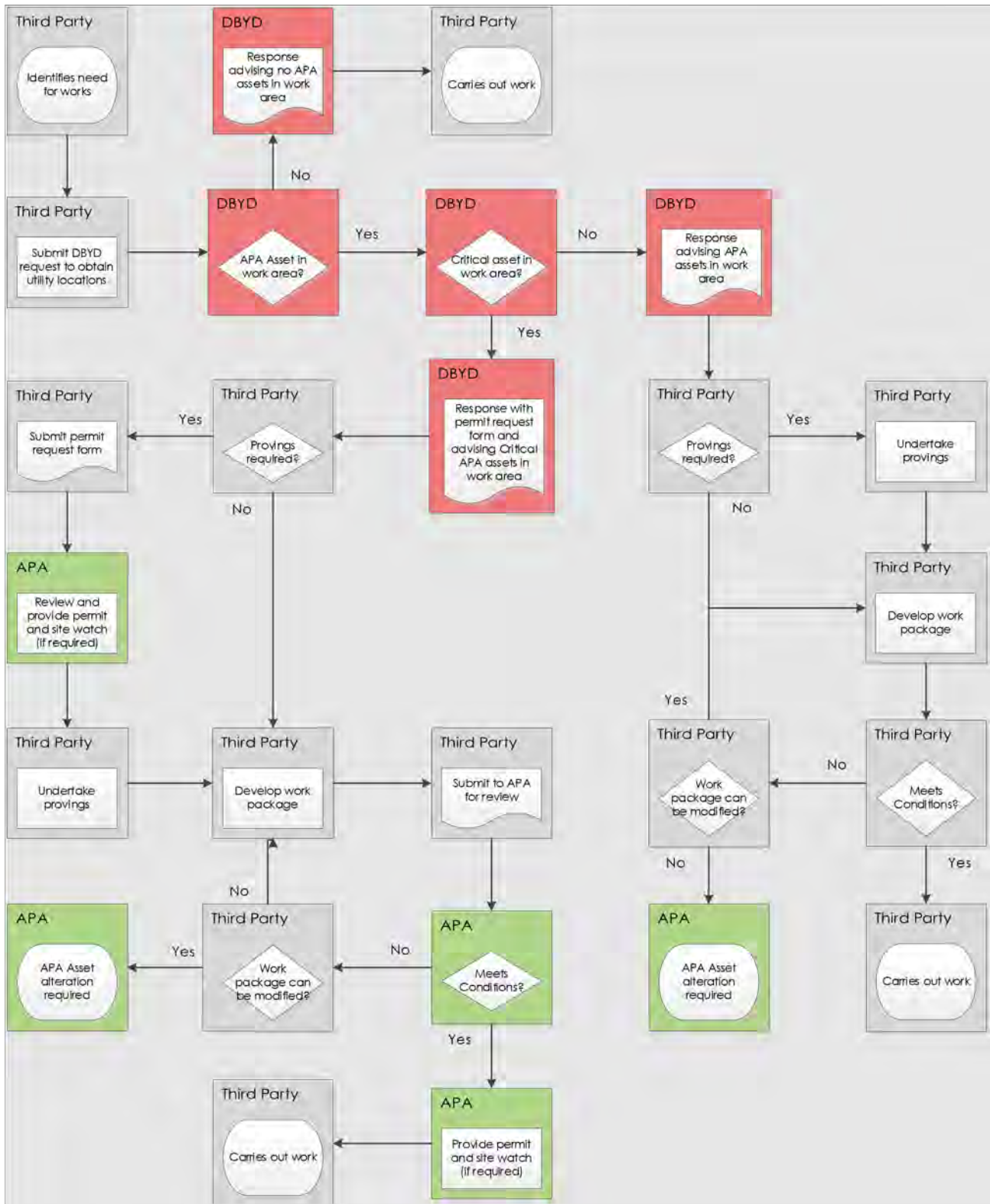

# Before You Dig Australia

Classification: Networks

**Enquiry Date:** 17/12/2024  
**Sequence Number:** 248885697  
**Work Site Address:** 5 Teasel Cr  
Forest Lake  
QLD 4078





For your immediate information **THERE IS A GAS PIPELINE OR INFRASTRUCTURE (Gas Assets) located in close vicinity to your works.**

**Enquiry Date:** 17/12/2024  
**Enquirer:** Abigail Mercado

---

**Sequence Number:** 248885697  
**Worksite Address:** 5 Teasel Cr  
Forest Lake  
QLD 4078

---

Thank you for your Before You Dig enquiry regarding the location of gas assets.

**We confirm there are Gas Assets located in close vicinity of the above location. Damage to gas assets may result in explosion, fire and personal injury.**

---

Please ensure you read all the relevant information contained in this response to your BYDA enquiry including reviewing the **APA Guidelines for Works Near Existing Gas Assets** and clearly understand and comply with all requirements relating to your scope of work.

If you have any queries relating to this information, contact the APA Before You Dig Officer for clarification. Refer to contact points listed on the following pages.



# Before You Dig Checklist



## 1. Plan

- Review maps provided with this BYDA response and confirm the location of your work site is correct.
- Review the **APA Guidelines for Works Near Existing Gas Assets** and clearly understand requirements relating to my scope of work.



## 2. Prepare

- Electronically locate gas assets and mark locations.
- Note: Enquirers should still look for visible evidence of gas assets at the worksite not shown on plans.



## 3. Pothole

- Physically confirm ('prove') the location of gas assets by potholing by hand excavation or non- destructive vacuum excavation methods in accordance with **APA Guidelines for Works Near Existing Gas Assets**.
- Road authorities, councils, utilities and their authorised contractors and agents are responsible to pothole or use other suitable methods to verify the location and depth of all gas assets, including gas (inlet) services, prior to commencing any works.



## 4. Protect

- Protect gas assets by maintaining clearances whilst excavating and following conditions provided by APA.
- Where required by APA, only conducting work in proximity to gas assets while Site Watch is on site.
- Where applicable, APA Authority To Work permit conditions are clearly understood and complied with.
- Strap and support exposed mains and inlet services. Cover exposed mains to prevent damage until the excavation can be restored permanently.



## 5. Proceed

- Only proceed with your work once you have completed all the planning, preparation, potholing and protection requirements.
- APA BYDA response (including maps) are on site for reference at all times, and less than 30 days old.

Site Address 5 Teasel Cr  
Forest Lake  
QLD

4078

Sequence No 248885697

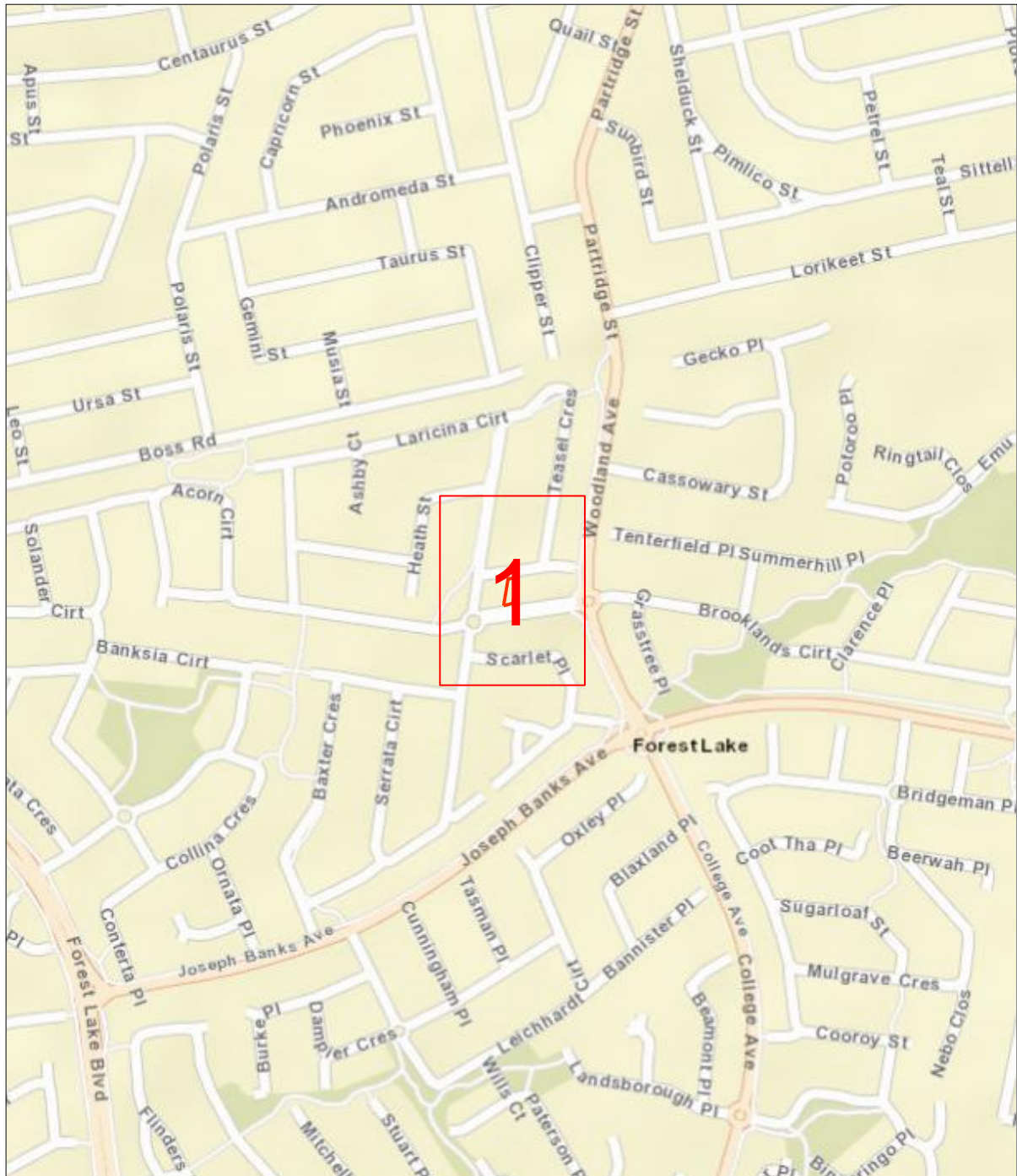

Scale 1: 6000

Map Sources: Esri, Garmin, HERE, FAO, NOAA, USGS,  
© OpenStreetMap contributors, and the GIS User Community



Enquiry Area

Map Key Area



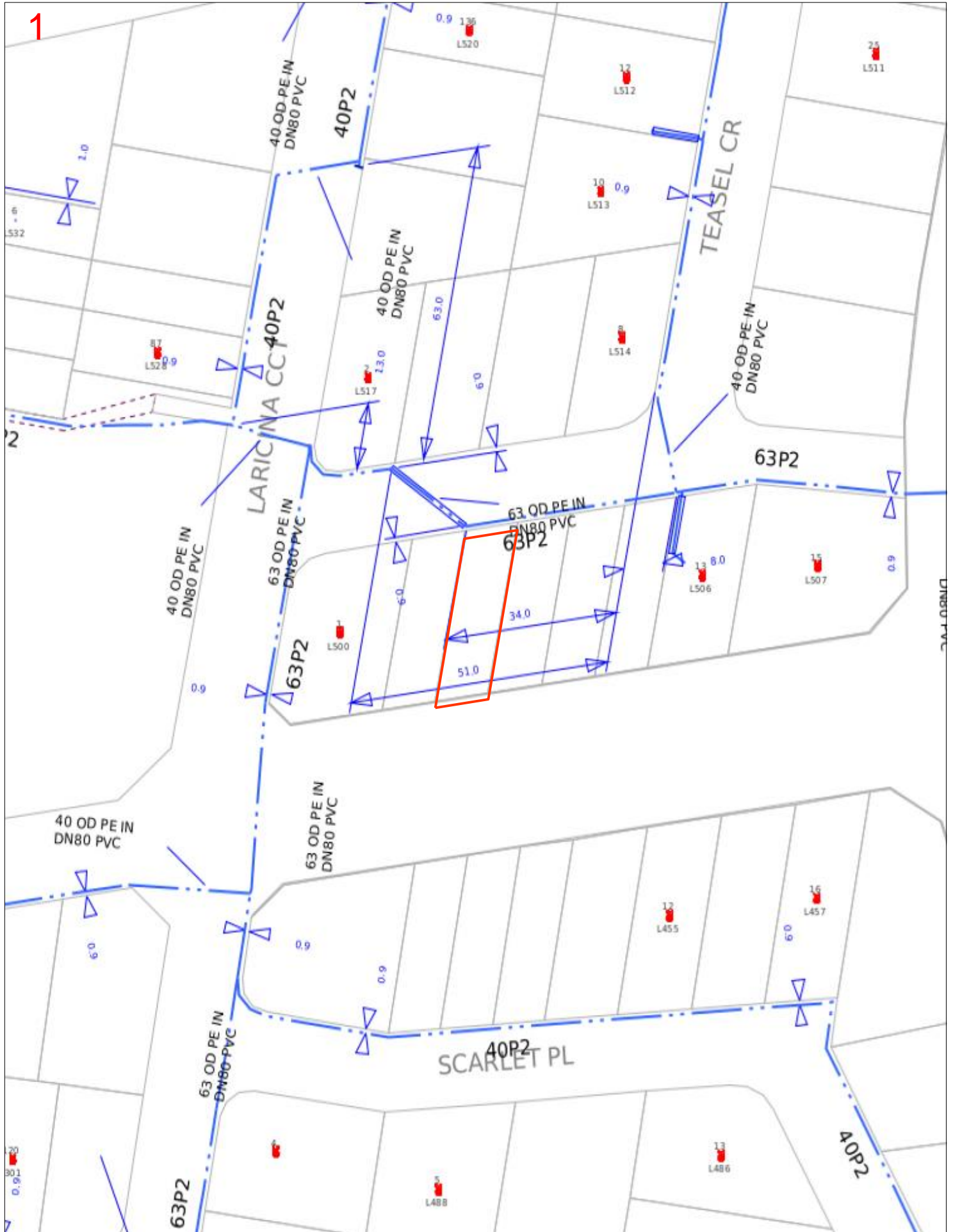

Scale 1:700 map

Map Sources: Esri, Garmin, HERE, FAO, NOAA, USGS, © OpenStreetMap contributors, and the GIS User Community



Enquiry Area

Map Key Area



## Map Symbolology

Pipe	Pipe code and material	Object
Low pressure	C* (for example, C2) Cast iron	Valve
Medium pressure	CU Copper	Buried valve
High pressure	N2 Nylon	Regulator
Transmission pressure	P* Polyethylene (PE)	Gas supplied = yes
Critical main (behind pipe)	P6, P7, P9–P12 Medium density PE	CP rectifier terminal
Proposed (pressure by colour)	P2, P4, P8 High density PE	CP test station
LPG (pressure by colour)	S* Steel	CP anode
Abandoned	W2 Wrought galv iron	CP bond wire
Idle/inactive	W3 PE coat wrought galv iron	Syphon
Sleeve		Trace wire point
Casing (behind pipe)		
Area	Abbreviation	
BYDA area of interest	BoK Back of kerb	FoK Front of kerb
	C Depth of cover	Galv Galvanized
	CP Cathodic protection	NTI Not tied in

### Example

Pipe	Pipe code
 40P6 in 80C2    40 mm high pressure medium density poly in an 80 mm cast iron casing	Pipe diameter in millimetres is shown before pipe code. 40P6 = 40 mm nominal diameter
 63S8    63 mm medium pressure steel	

*This map was created in colour and should be printed in colour*

## Site Watch

Site Watch is where an APA field officer attends your work site to monitor and ensure controls are in place to protect critical gas assets from damage during work.

The following rates apply for this service (1 hour minimum charge):

Item	Rate (excl. gst)
Site Watch - Business Hours	\$143.42 per hour
Site Watch - After Hours	\$175.06 per hour
Cancellation Fee Fee applies where cancellations received after 12pm (midday) 1 business day prior to the booking	\$286.84

- Contact APA - Before You Dig officer for state specific hours of business.

## Contacts

Contacts APA Group	
Enquiry	Contact Numbers
General enquiries or feedback regarding this information or gas assets.	APA - Before You Dig Officer Phone: 1800 085 628 Email: BYDA_APA@apa.com.au
Gas Emergencies	Phone: 1800 GAS LEAK (1800 427 532)

## Important Information

- Refer to requirements relating to construction, excavation and other work activities in the **APA Guidelines for Works Near Existing Gas Assets** document with this BYDA response.
- BYDA enquiries are valid for 30 days. If your works commence after 30 days from the date of this response a new enquiry is required to validate location information.
- For some BYDA enquiries, you may receive two (2) responses from APA. Please read both responses carefully as they relate to different assets.
- Gas (inlet) services connecting Gas Assets in the street to the gas meter on the property are not marked on the map. South Australia Only - if a meter box is installed on the property, a sketch of the gas service location may be found inside the gas meter box. APA does not guarantee the accuracy or completeness of these sketches.

## Disclaimer and legal details

- This information is valid for 30 days from the date of this response.
- This information has been generated by an automated system based on the area highlighted in your BYDA request and has not been independently verified.
- Map location information is provided as AS5488-2022 Quality Level D, as such supplied location information is indicative only.
- Whilst APA has taken reasonable steps to ensure that the information supplied is accurate, the information is provided strictly on the condition that no assurance, representation, warranty or guarantee (express or implied) is given by APA in relation to the information (including without limitation quality, accuracy, reliability, completeness, currency, sustainability, or suitability for any particular purpose) except that the information has been disclosed in good faith.
- Any party who undertakes activities in the vicinity of APA operated assets has a legal duty of care that must be observed. This legal obligation requires all parties to adhere to a standard of reasonable care while performing any acts that could foreseeably harm these assets.

The background features a solid red field with several large, white, angular geometric shapes. One prominent shape is a large white polygon on the left side, and another is a white triangle on the right side. The text 'apa' is positioned in the upper right area of the red background.

**apa**

**Referral**  
248885698

**Member Phone**  
(07) 3403 8888

## Responses from this member

**Response received** Tue 17 Dec 2024 12.43pm

<b>File name</b>	<b>Page</b>
Response Body	57
ASSET 248885698.pdf	58



**Attention: Abigail Mercado**

Thank you for your enquiry with Brisbane City Council's Before You Dig service.

**Job Number:** 38295369  
**Sequence Number:** 248885698

The attached .PDF file contains the location of Council's relevant services for your requested location. If you are having trouble viewing these files, it is recommended you upgrade your version of Adobe Reader. You can download the latest version of Adobe Reader for free at <http://get.adobe.com/reader/>

If you require more information, Council offers a convenient online mapping subscription service containing additional services data. The online service offers a wide variety of spatial information suitable for searches over large areas, including information previously available only by visiting Council's Customer Service Centres.

For more information on Council's online mapping services, visit <http://www.brisbane.qld.gov.au/planning-building/planning-guidelines-and-tools/online-tools/ebimap/index.htm>

Kind regards,

Brisbane City Council  
Before You Dig



**Job # 38295369**  
**Seq # 248885698**  
 Provider: Brisbane City Council  
 Telephone: (07) 3403 8888

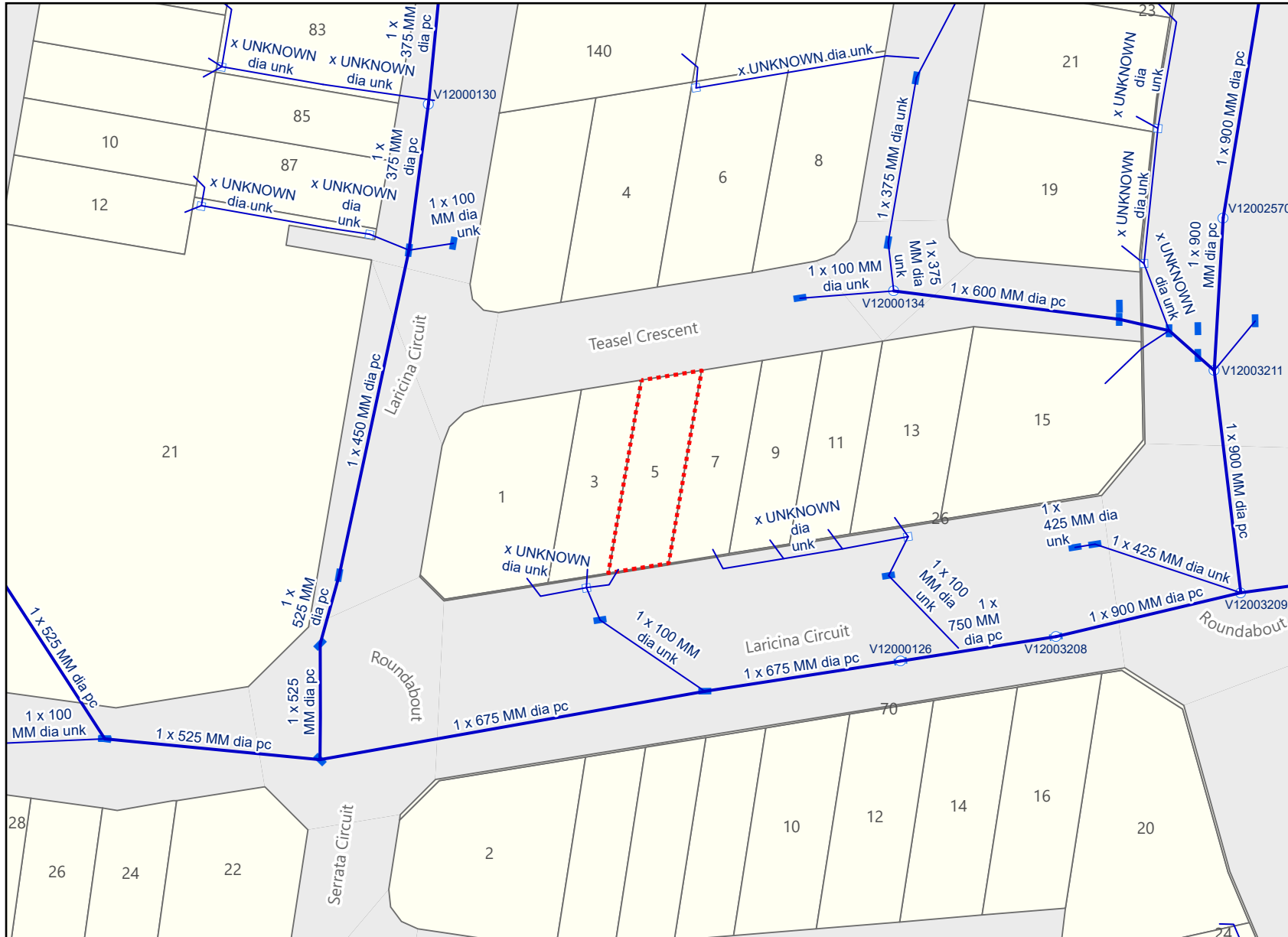

### Legend

- BYDA Enquiry

### Stormwater Network

- Stormwater Drain
- Stormwater Gully / Roofwater Connection
- Stormwater Maintenance Hole
- Stormwater Roofwater Pit
- Stormwater Gully Pit

**Disclaimer:**  
 © Brisbane City Council [2020]  
 In consideration of Council, and the copyright owners listed below, permitting the use of this data, you acknowledge and agree that Council, and the copyright owners, give no warranty in relation to the data (including accuracy, reliability, completeness, currency or suitability) and accept no liability (including without limitation, liability in negligence) for any loss, damage or costs (including consequential damage), relating to any use of this data.  
 Data must not be used for direct marketing or be used in breach of the privacy laws.

Copyright of data is as follows:  
 Cadastre and Street Names © 2020 State of Queensland (Department of Natural Resources, Mines and Energy)

Caution: This map may contain the locations of abandoned underground asbestos pipes. Council gives no warranty to the completeness or accuracy of these records. Appropriate care needs to be taken in all cases.

In an emergency contact Brisbane City Council on 07 3403 8888  
 17/12/24 (valid for 30 days)

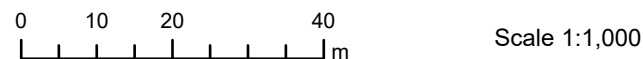

Plans generated by SmarterWX™ Automate

**Referral**  
248885699

**Member Phone**  
13 12 53

## Responses from this member

**Response received** Tue 17 Dec 2024 12.46pm

<b>File name</b>	<b>Page</b>
Response Body	60
248885699 - Energex Plan.pdf	63
Working Near Overhead and Underground Electric Lines.pdf	64
Energex BYDA Terms and Conditions.pdf	92

# Assets found

## Before You Dig Australia (BYDA) Request

**Please DO NOT SEND A REPLY to this email as it has been automatically generated and replies are not monitored.**

The attached Plan details ENERGEX's Assets in relation to Your nominated search area.

Ensure You read and understand the important notes outlined below.

<b>You:</b>	<b>BYDA Enquiry No:</b>
Abigail Mercado	248885699
<b>Company:</b>	<b>Date of Response:</b>
ilookproperty	17 Dec 2024
<b>Search Location:</b>	<b>Period of Plan Validity:</b>
5 Teasel Cr Forest Lake, QLD 4078	4 Weeks
<b>External Comments (if any):</b>	

**WARNING: When working in the vicinity of Energex's Assets You have a legal Duty of Care that must be observed.**

### It is important that You note:

1. Immediately report life threatening emergencies to Emergency Services on **000** or to ENERGEX on **13 19 62**.
2. Please read and understand all the information and disclaimers provided - including the Terms and Conditions on the attached pages.
3. We have only searched the area which has been nominated in the request. If this nominated area is not what You require, please resubmit another enquiry with BYDA.
4. Plans provided by ENERGEX are only an indication of the presence of underground Assets within the nominated area. Locations provided are approximate and the plans are not suitable for scaling purposes, as exact ground cover and alignments cannot be provided. You must confirm the exact location of Assets by use of an electronic cable locator followed by careful, non-mechanical excavation (i.e. potholing).
5. Plans provided by ENERGEX do not encompass ENERGEX's overhead Assets.
6. ENERGEX, its servants or agents shall not be liable for any loss or damage caused or occasioned by the use of plans and details supplied pursuant to the BYDA Request and You agree to indemnify ENERGEX against any claim or demand for any such loss or damage to You, Your servants or Your agents.
7. You are responsible for any damage to underground Assets caused by works pursuant to or in any way connected with this BYDA Request.

8. In addition to underground cables marked on attached plan, there could be underground earth conductors, underground substation earth conductors, Multiple Earthed Networks (MEN) conductors, Single Wire Earth Return (SWER) Substation Earth Conductors, Air Break Switch (ABS) Earth Mats or Consumer Mains in the vicinity or private underground cables (inc. consumers' mains that may run from ENERGEX mains onto private property) in the vicinity of the nominated work area(s) that are not marked on the plans.
9. Independent underground cable locators can be found by using the "Find a locator" option available within the BYDA enquiry response with LV Cable (up to 1kV), HV Cable (1kV-<33kV) & HV cable (33kV and over) displayed.
10. The ENERGEX Before You Dig Australia (BYDA) information map(s) provide the vicinity of underground cable and will not be adequate for conveyancing purposes. A Request for Search (Property Search) can be arranged through ENERGEX.
11. The attached plans are only valid for a period of four weeks from receipt. If excavation does not commence within four weeks, a new plan should be obtained.
12. The ENERGEX BYDA map (named maps.pdf) may contain shaded area(s), indicating the location of planned work(s). Should You find planned works that You believe may affect Your planned work(s), please contact the ENERGEX BYDA team on the details listed below.
13. ENERGEX may contact You to discuss Your proposed excavation in the vicinity of feeders identified on the attached plan(s).
14. Do not access any Assets, for example, conduits, cables, pits or cabinets.
15. Your work will need to comply with:
  - [Working near overhead and underground electric lines - Electrical safety code of practice 2020](#)
  - [Managing Electrical Risk in Workplace Electrical Safety Code of Practice \(2013\)](#)
  - [Excavation Work Code of Practice \(2021\)](#)

**NOTE:** Where Your proposed work location contains ENERGEX 33kV or greater Underground cables please access the [Energen before you dig Website](#) for more information.

General enquiries (7:00am - 5:30pm Mon to Fri) **13 12 53**

Life threatening emergencies only triple zero (000) or **13 19 62**

To re-submit or change the nominated search area please visit [BYDA.com.au](#)

E: [custserve@energex.com.au](mailto:custserve@energex.com.au)

E: [byda@energyq.com.au](mailto:byda@energyq.com.au)

ABN: 40 078 849 055



**Disclaimer:** While reasonable measures have been taken to ensure the accuracy of the information contained in this plan response, neither Energen nor PelicanCorp shall have any liability whatsoever in relation to any loss, damage, cost or expense arising from the use of this plan response or the information contained in it or the completeness or accuracy of such information. Use of such information is subject to and constitutes acceptance of these terms.

If you are unable to launch any of the files for viewing and printing, you may need to download and install free viewing and printing software such as [Adobe Acrobat Reader \(for PDF files\)](#)





BYDA

Sequence: 248885699  
Date: 17/12/2024

Scale: 1:500  
Tile No: **Tile No: 1**

**CAUTION - HIGH VOLTAGE**

LEGEND

- Substation
- Cable Marker
- Pit
- Pole
- Pillar
- LV Cable (up to 1kV)
- HV Cable (1kV - <33kV)
- HV Cable (33kV and over)
- Pit Boundary
- Planned Work Area

AS5488 Category "D" Plan



**DISCLAIMER:** While reasonable measures have been taken to ensure the accuracy of the information contained in this plan response, neither Energex nor Pelican Corp shall have any liability whatsoever in relation to any loss, damage, cost or expense arising from the use of this plan response or the information contained in it or the completeness or accuracy of such information. Use of such information is subject to and constitutes acceptance of these terms.

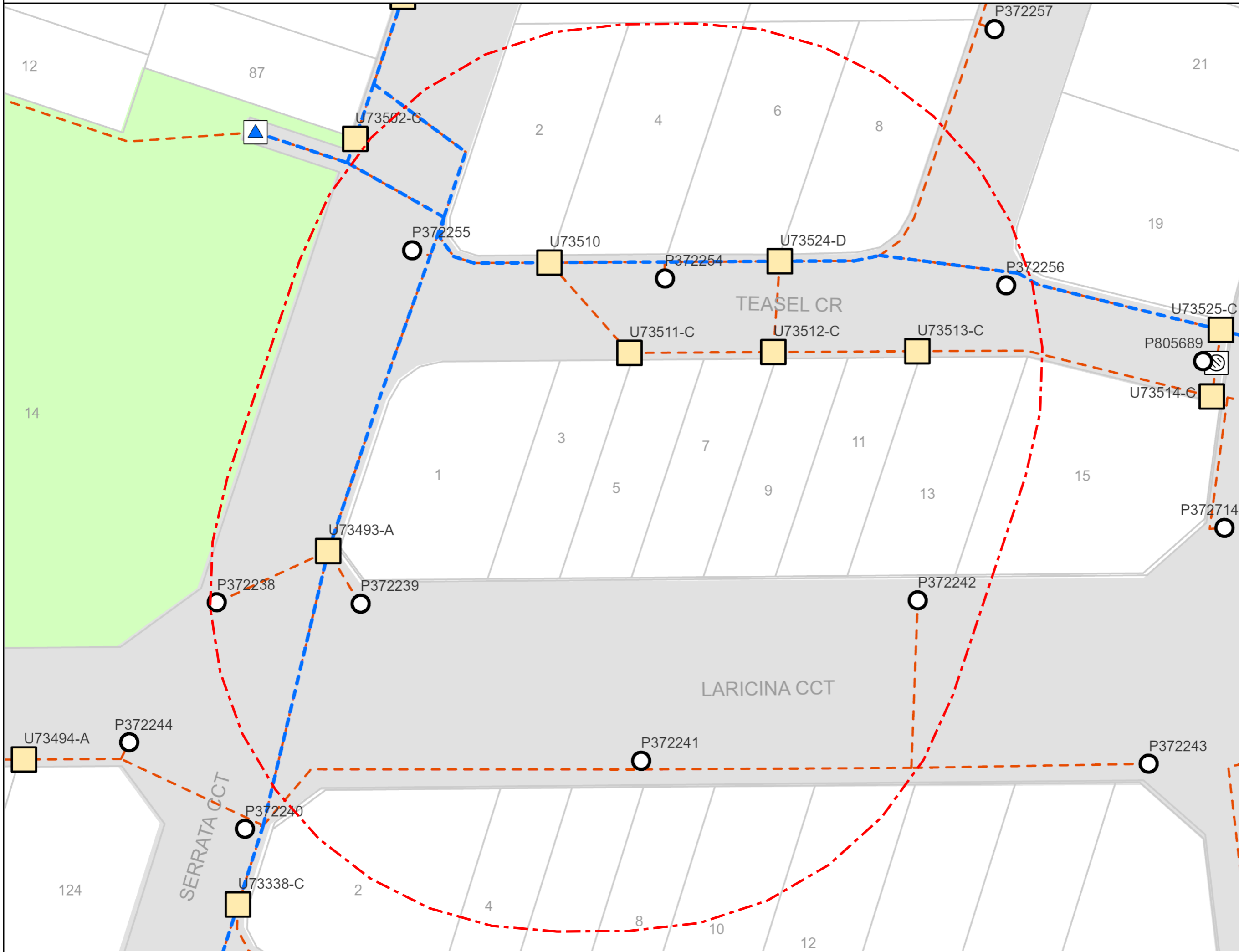



Scan to provide feedback

# ELECTRICITY ENTITY REQUIREMENTS - WORKING NEAR OVERHEAD AND UNDERGROUND ELECTRIC LINES



Part of Energy Queensland

**Purpose:** This instruction describes Electricity Entity requirements for working or operating plant near any Electricity Entity Overhead or Underground electric lines.

**Scope:** This instruction applies to anyone who may be contemplating working or operating plant near any Electricity Entity Overhead or Underground electric lines.

<b>Person responsible for ensuring compliance with this Work Practice:</b>	All EQL employees have responsibility to comply with listed controls.
<b>Measures in place to ensure compliance with the Work Practice:</b>	Team Leaders must provide appropriate supervision and / or assurance in addition to formal assurance activities performed by EQL.
<b>Person(s) responsible for reviewing the Work Practice:</b>	Prior to any task listed on this Work Practice being performed, the contents must be understood by all workers exposed to the hazard on site. (i.e. using HazChat).
<b>Work Practice control and guidance to be reviewed:</b>	All controls for this task must be verified, monitored, and maintained by crews for the duration of works.

**Key tools and equipment:** N/A

**Note:**  
 Prior to works commencing the contents of supporting Work Practices must be understood.  
 If at any time the control or procedural guidance in this Work Practice cannot be applied or are not suitable, work must cease, and advice must be sought from your leader or a Technical SME before proceeding.  
 Work Practices may be provided as a means of sharing hazard and control information to EQL contractors. But it is the responsibility of the contractor to provide their own safe system of work (including, consultation, training, instruction, and supervision to reduce risk SFAIRP)

[Table of Contents](#)



## 1. ABOUT THIS GUIDE

This guide to working near the Electricity Entity network is designed to assist any person working, contemplating work or operating plant near any Electricity Entity overhead or underground electric lines to meet their duties under the Work Health and Safety Act 2011, Electrical Safety Act 2002, Electrical Safety Regulation 2013 and relevant Codes of Practice including Electrical Safety Code of Practice 2020 Working Near Overhead and Underground Electric Lines and help to identify the steps needed to ensure risks are minimised for all who work or are likely to be affected by the work in these situations.

“The Electrical Code of Practice 2020 Working Near Overhead and Under Ground Electric Lines” provides practical advice on ways to manage electrical risk when working near electric lines including the exclusion zones that apply. An electronic copy of this Code of Practice as well as, Electrical Safety Act and Regulation is available at the Queensland Government Electrical Safety Office web site at <https://www.worksafe.qld.gov.au/electricalsafety>. You should obtain a copy and read this material, to enable you to fully understand your obligations, and prospective means of complying with them.

### 1.1. Who does the Electrical Safety Code of Practice 2020 - Working Near Overhead and Underground Electric Lines and Electricity Entity Requirements apply to?

A person, worker or Person Conducting a Business or Undertaking (PCBU) at a workplace is required to comply with the requirements of Electrical Safety Regulation 2013 Part 5 Overhead and Underground Electric Lines and Electrical Safety Code of Practice 2020 Working Near Overhead and Underground Electric Lines to ensure that no person, plant or thing comes within an unsafe distance (exclusion zone) of an overhead electric line. Compliance with these regulatory requirements is essential to reduce the risk of electric shock and contact with Electricity Entity electric lines and other assets which can have deadly consequences.

Examples of work activities where risk of person, plant or equipment coming near or into contact with overhead electric lines include but are not limited to:

- Pruning or felling trees or vegetation near overhead electric lines, including the service wire into a building.
- Carrying out building work, scaffolding or demolition adjacent to overhead electric lines.
- Painting fascia, replacing roofing, guttering or external cladding near service line point of entry to a building.
- Operating cranes, tip trucks, cane harvesters, elevated work platforms, fork lifts, grain augers, excavators, irrigators, etc near OH electric lines.
- Erecting or maintaining advertising signs or billboards near overhead electric lines.
- Dam or levee bank construction.

Examples of work activities that could involve risk of damage to underground cables or earthing systems include but are not limited to:

- Digging holes, excavating, sawing, trenching, under boring, sinking bore holes, earthworks or laying cables, pipes, etc or driving implements into the ground (e.g. star pickets, fence posts) near where underground cables or earthing systems may be located.

### 1.2. Are you working or planning to work near overhead or underground electric lines?

Electrical Safety Regulation Section 68 requires that before carrying out any work at a workplace where there is a risk of any person, plant or thing encroaching the exclusion zone of overhead electric lines, the person, worker or PCBU is required to ensure that the potential hazards are identified, a risk assessment conducted and the necessary control measures implemented to minimise electrical safety risks to ensure the safety of all workers and other persons at the workplace. The Electrical Safety Regulation 2013 and Electrical Safety Code of Practice 2020 - Working Near Overhead and Underground Electric Lines detail the Exclusion Zones that must be maintained.

### 1.2.1 Work near overhead electric lines

Where a risk assessment has been conducted and control measures implemented in accordance with requirement of Electrical Safety Code of Practice 2020 - Working Near Overhead and Underground Electric Lines and Electricity Entity Requirements (this document) and it has identified that exclusion zones from overhead electric lines cannot be maintained, the person, worker or PCBU is then required to contact Electricity Entity and request written Safety Advice (refer Section 1.3 below).

The person, worker or PCBU shall be required to maintain exclusion zones until such times as the Electricity Entity has provided written Safety Advice. A person, worker or PCBU would not be required to contact the Electricity Entity and request a written Safety Advice where their risk assessment and implemented control measures ensure that exclusion zones from overhead electric lines will be maintained throughout performance of work to be undertaken at a particular site.

### 1.2.2 Exclusion Zones

An exclusion zone is a safety envelope around an overhead electric line. No part of a worker, operating plant or vehicle should enter an exclusion zone while the overhead electric line is energised (live).

Exclusion zones keep people, operating plant and vehicles a safe distance from energised overhead lines.

You must keep yourself and anything associated with the work activity out of the exclusion zone (e.g. a safe distance) unless it is not reasonably practicable to do so; and the person conducting a business or undertaking complies with the requirements of Section 68(2) of the Electrical Safety Regulation in relation to:

- conducting a risk assessment.
- implementing control measures
- adhering to any requirements of an Electricity Entity responsible for the line.

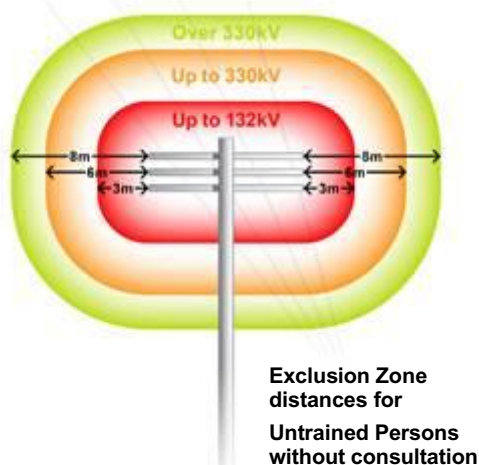

**Exclusion Zone – Untrained Person (distances in mm)**

Nominal phase to phase voltage of electric line	Untrained Person		
	Person	Operating Plant	Operating Vehicles
Insulated LV: Consultation with and verified by AP (Electrical)	No exclusion zone prescribed	1000	300
LV with NO consultation with Electricity Entity	3000	3000	600
LV With consultation with Electricity Entity	1000		
>LV up to 33 kV with NO consultation with Electricity Entity	3000		900
LV up to 33 kV with consultation with Electricity Entity	2000		
>33 kV up to 132 kV	3000	6000	2100
>132 kV up to 220 kV	4500		2900
>220 kV up to 275 kV	5000		

Information extracted from Electrical Safety Regulation 2013 Schedule 2

**Exclusion Zone – Instructed Person and Authorised Person (distances in mm)**

Nominal phase to phase Voltage of electric line	Instructed Person (IP) & Authorised Person (AP)		
	AP and IP	Operating Plant with Safety Observer or another Safe System of work	Operating of Vehicles
Insulated LV: Consultation with and verified by AP (Electrical)	No exclusion zone prescribed	No exclusion zone prescribed	No exclusion zone prescribed
LV	No exclusion zone prescribed	1000	600
>LV up to 33 kV	700	1200	700
>33 kV up to 50 kV	750	1300	750
>50 kV up to 66 kV	1000	1400	1000
>66 kV up to 110 kV		1800	
>110 up to 132	1200		

Information extracted from Electrical Safety Regulation 2013 Schedule 2

**1.2.3 Work near underground electrical lines (underground electrical assets)**

Before carrying out any earthworks at a location, the person, worker or PCBU is required to ensure that the potential hazards are identified, a risk assessment conducted and the necessary control measures implemented to minimise the risk of damaging identified or unidentified underground electrical assets and to ensure the safety of all workers and other persons at the workplace. The Electrical Safety Regulation 2013 and Electrical Safety Code of Practice 2020 - Working Near Overhead and Underground Electric Lines and Electricity Entity Requirements detail the requirement for work near underground electric lines.

There is no exclusion zone applicable for underground electrical assets – conduits, cables (unless cable is damaged, or conductors or terminations have been exposed) therefore there is **no requirement for a written Safety Advice** to be requested by a person, worker or PCBU, or issued by an electricity entity for work at a site that only involves identified or unidentified underground electrical assets (e.g. does not involved overhead electric lines or other exposed live parts within the work location).

**1.3. Obtaining Safety Advice**

To obtain written Safety Advice where identified as being required in Section 1.2.1 above, complete and return (by fax or email) the applicable Safety Advice Request Form which is accessible via the electricity entity website link on page 9:

- Energex Form - Application for Safety Advice – Working near Energex exposed live parts
- Ergon Energy Safety Advice Request Form

On receipt, the Electricity Entity will contact the Applicant to advise date and time to meet at site to provide written Safety Advice. It is advisable to bring to the meeting your copy of the Electrical Safety Code of Practice 2020 Working Near Overhead and Underground Electric Lines (and Before You Dig Australia Plan for location of underground assets where required), as reference to this will be necessary during the meeting. Written Safety Advice and/or other control measures provided by the Electricity Entity may incur a fee.

Failure to adhere to the Electrical Safety Regulation Section 68 requirements and mandatory control measures as documented on written Safety Advice as issued will result in written non-compliance advice being sent to the Electrical Safety Office.

Where this work is required to occur on a regular basis at a workplace, the PCBU may consider arranging to have one or more employees trained and subsequently accredited with the Electricity Entity as Authorised Persons.

#### 1.4. Authorised Person and how to become one?

Under the Electrical Safety Regulation 2013, the exclusion zones for working near or operating plant or vehicles near exposed, low voltage or high voltage electric lines vary depending on whether a person is classed as an “Untrained Person”, “Authorised Person” or “Instructed Person”. An Authorised Person is permitted to carry out work closer to the electric lines than an Untrained Person (refer Electrical Safety Code of Practice 2020 Working Near Overhead and Underground Electric Lines Appendix B Exclusion Zones for Overhead Electric Lines).

To become an Authorised Person, the employer / self-employed person must first satisfy the “person in control” of the electric line, in this case the Electricity Entity, that their Applicants possess the required competencies. They must then apply in writing to Electricity Entity for approval.

Removal or replacement of LV service fuse to permit work on consumers’ mains, installation switchboard, consumer’s terminals or eliminate an exclusion that would exist requires the Electrical Mechanic to hold a current Queensland Electrical Mechanic Licence and perform the work in accordance with their documented safe system of work.

**NOTE:** It is not permissible to replace a blown LV service fuse(s) after loss of supply to consumer’s installation or to alter Electricity Entity LV aerial services.

#### 1.5. Contacting Electricity Entity for Safety Advice or Authorised Person Enquiries

By phone

- call Electricity Entity on General Enquiries phone number (refer page 3).

By email

- **Energex:** [custserve@energex.com.au](mailto:custserve@energex.com.au) or [authorisedperson@energex.com.au](mailto:authorisedperson@energex.com.au)
- **Ergon Energy:** [safetyadvice@ergon.com.au](mailto:safetyadvice@ergon.com.au)

Website

- **Energex:** <https://www.energex.com.au/home/safety/working-near-powerlines>
- **Ergon Energy:** <https://www.ergon.com.au/network/safety/business-safety/the-outdoor-workplace/working-near-powerlines>

## 2. OVERHEAD ELECTRIC LINES

The following table sets out preparatory work options that may be required to be performed by the Electricity Entity (or electrical contractor where identified as being permitted who is an Authorised Person - Electrical) to assist a person, worker or PCBU in minimising the electrical safety risks of, encroaching within the exclusion zone or contact with electric lines.

Category of work		Description	Costing arrangement
<b>Safety Advice</b>	Base information	Provide Safety Advice	<b>Nil cost to customer</b>
<b>LV Service isolation</b>	1. Isolation carried out by customer's electrical contractor	Isolation of overhead or underground service by removal of the service fuse(s). (Preferred option to isolate supply and eliminate the exclusion zone).	No involvement by the Electricity Entity. May be a cost charged by the customer's electrical contractor.
	2. Isolation carried out by Electricity Entity	Customer requested isolation of overhead or underground service by removal of the service fuse(s); or Customer requested physical disconnection and reconnection of overhead or underground service.	<b>Cost to customer.</b>
<b>Insulation integrity verification</b>	3. Verification of insulation integrity to reduce exclusion zone to no exclusion zone prescribed e.g. no contact permitted	Verification of insulation integrity to classify as insulated service – Insulation integrity can only be verified at the time of inspection – visual inspection is required before confirmation in all cases. When service insulation integrity verified - no exclusion zone prescribed e.g. no contact permitted.	<b>Cost to customer.</b>
<b>Service replacement</b>	4. Open wire service, service fuse(s) at house/building	Replacement of service with new XLPE service cable and service fuse(s) installed at origin (pole end) of service to allow isolation of service. Insulation integrity can be verified for new XLPE services at the time of installation – visual inspection is required before confirmation.	<b>Nil cost to customer</b> for service replacement. Customer responsible for necessary installation, Mains Connection Box and service support bracket upgrade and associated costs if required.
		Service installations where: a. the consumer's mains cannot be insulated and an exclusion zone must be maintained, and b. the service cannot be isolated at the service fuse. Service to be isolated by breaking the service cable connection to the LV mains at the pole. Service fuse(s) to be installed at origin (pole end) of service prior to reconnection.	<b>Nil cost to customer</b> for first disconnection and reconnection. <b>Cost to customer</b> for subsequent requests.

Category of work		Description	Costing arrangement
	5. All other service replacements	Customer requested replacement of existing service with new XLPE service cable to classify as insulated service, in lieu of isolation, to allow work close (no exclusion zone prescribed e.g. no contact permitted). Service fuse(s) to be installed at origin (pole end) of service.	<b>Cost to customer</b> for service replacement. Customer responsible for necessary installation, Mains Connection Box and service support bracket upgrade and associated costs if required.
<b>Tiger Tails</b>	6. Installation of Tiger Tails (for visual indication only – not for providing electrical insulation of LV mains)	Customer requested coverage of LV mains for visual indication only (not permitted on HV mains). The Entity may also fit tiger tails to LV service line for visual indication only.	<b>Cost to customer.</b>
<b>Aerial Markers</b>	7. Installation of aerial marker flags or balls (for visual indication only)	Customer requested temporary or permanent installation of appropriate aerial marker devices on LV or HV mains.	<b>Cost to customer.</b>
<b>Switching</b>	8. Customer requested switching	Customer requested switching to allow customer/contractor to work close (no exclusion zone prescribed e.g. no contact permitted).	<b>Cost to customer.</b>

**2.1. Isolation of supply to customer installation to eliminate exclusion zone around LV service line**

An Electrical Mechanic (holding current Queensland Licence) working on behalf of an electrical contractor and accredited with the Electricity Entity as an Authorised Person (Electrical) is permitted to remove and replace LV service fuse(s) when isolation of customer LV service line is required to eliminate the exclusion zone around the LV service line, or to work on the customer’s mains and/or switchboard. Isolation of the customer’s LV service line by an Authorised Person (Electrical) is only permitted at an underground service pillar or service pole by removing a fuse wedge(s) from a service line, in accordance with Electricity Industry practices e.g. from ground level using appropriate insulated tools, PPE and insulating mats. In those situations where the service fuse/circuit breaker is not located at supply end of the LV service, contact the Electricity Entity to arrange for Safety Advice where elimination of exclusion zone around LV service line is required.

Any controls used by the Authorised Person (Electrical) to identify and confirm isolation and ensure supply to the customer’s installation is not inadvertently re-energised shall comply with Electrical Safety Regulation 2013 Section 14 and 15 requirements.

**NOTE:** The Authorised Person (Electrical) will not be permitted to replace a blown LV service fuse(s) after loss of supply to a customer’s installation or to alter the Electricity Entity overhead LV services. The low voltage pole top service fuse shall only be removed by use of an approved, in test, insulated telescopic pole device while standing at ground level and wearing class 00 insulating gloves. At no time is it permissible for an Authorised Person (Electrical) to climb or work aloft on the Electricity Entity’s poles or assets unless approved by the Electricity Entity.

**2.2. Operating Plant**

It can be extremely difficult for operating plant operators to see overhead lines and to judge distances from them. Contact with overhead lines can pose a risk of grounding live conductors and electrocution.

In many cases the likelihood of damage or injury can be reduced by setting up and operating the machinery well clear of overhead electric lines.

In situations where operating plant is operated by an Authorised Person or Instructed Person without a Safety Observer or another safe system, the exclusion zone requirements (refer Section 1) for an Untrained Person applies (refer Electrical Safety Regulation 2013 Schedule 2 or Electrical Safety Code of Practice 2020 Working Near Overhead and Underground Electric Lines).

For an Authorised or Instructed Person and their Operating Plant to approach overhead electric lines closer than the exclusion zone distances for an Untrained Person, a Safety Observer or another safe system shall be used. Refer to the Electrical Safety Regulation 2013 and the Electrical Safety Code of Practice 2020 - Working Near Overhead and Underground Electric Lines for exclusion zone distances for Authorised and Instructed Persons operating plant with a Safety Observer or another safe system.

Where a Safety Observer is used, the Safety Observer shall:

- Be trained to perform the role.
- Not be required to carry out any other duties at the time, and
- Not be required to observe more than one item of plant operating at a time, and
- Attend all times when the item of plant is operating.

Other control measures for operating plant may include, but are not restricted to:

- Constructing physical barriers or height warning indicators either side of the overhead electric line that are lower than the maximum travel height permissible without encroaching within the exclusion zone of the overhead electric line.
- Applying appropriate signage at least 8 to 10 m either side of overhead electric lines.
- Arrange for visual indicators such as Tiger Tails or aerial markers to fitted to the overhead electric lines – only erected by the Electricity Entity (tiger tails are only permitted on LV mains).
- Ground barriers, where appropriate.
- Informing workers of required work practices.
- Ensuring operators are aware of the height and reach of their machinery in both stowed and working positions.
- Lowering all machinery to the transport position when relocating.
- Providing workers with maps or diagrams showing the location of underground and overhead electric lines, and
- Where possible, directing work away from overhead electric lines not towards them.



### 2.3. Scaffolding Requirements

The following information provided is for guidance only and shall be read in conjunction with the Electrical Safety Regulation 2013, Electrical Safety Code of Practice 2020 - Working Near Overhead and Underground Electric Lines and AS/NZS 4576:1995: Guidelines for Scaffolding.

Requirements shall be complied with where scaffolding is required to be erected within 4 m of nearby overhead electric lines:

- The scaffolding shall not be erected before contacting and obtaining Safety Advice from the Electricity Entity.
- Erection of scaffolding to comply with requirements of AS/NZS 4576:1995: Guidelines for Scaffolding.

The scaffolding can be either:

- nonconductive material scaffolding; or



## PROCEDURE / INSTRUCTIONS

- metallic scaffolding with solid nonconductive barriers (with no gaps, holes or cuts) securely fixed to the outside and/or top of the scaffolding to prevent encroachment within exclusion zones or contact with the energised mains.

Where scaffolding is erected within 3 m of nearby overhead electric lines:

- It shall be fitted with fully enclosed non-conductive solid barriers to prevent encroachment within exclusion zones or contact with the energised mains fully enclosed.
- The person required to erect and/or disassemble scaffolding as well as the required solid barrier affixed to the scaffolding should be an Authorised Person (approved in writing by the Electricity Entity - refer requirements of Section 1.4 of this Reference).
- A Safety Observer shall be used during performance of this work where there is a risk of encroachment within 3 m of nearby energised overhead electric lines for voltages up to 33 kV. Additional requirements may apply for voltage levels above 33 kV, contact the Electricity Entity for consultation.
- Alternatively, consideration should be given to the de-energisation of the nearby electric lines where possible for the duration of this work. Additional requirements may apply for voltage levels above 33 kV, contact the Electricity Entity for consultation.
- Comply with the horizontal and vertical statutory clearances from overhead electric lines as set out in Electrical Safety Regulation 2013 Schedule 4.
- Persons are not permitted to go outside of or climb on top of the solid barrier fixed on the outside and/or top of the scaffolding.

Where an insulated low voltage service line passes through the scaffolding, it should either be de-energised for duration of work or be fully enclosed by non-conductive material (e.g. form ply).

Minimum statutory clearances from nearby overhead electric lines for scaffolding erected with barriers affixed.

Voltage Level	Horizontal Distance "A" (in metres)	Vertical Distance "B" (in metres)
Low voltage conductors (uninsulated)	1.5m	2.7m
Low voltage conductors (insulated) – these distances can only be applied after the integrity of the insulation has been verified by the Electricity Entity	0.3m	0.6m
Above LV and up to 33 kV (uninsulated)	1.5m	3.0m
Above LV and up to 33 kV (insulated)	Contact Electricity Entity for consultation.	
Above 33 kV (uninsulated)	Additional requirements may apply for voltage levels above 33 kV, contact the Electricity Entity for consultation.	

**NOTE:** Dimension's "A" and "B" is between the scaffolding and the closest conductor of the overhead electric line. Dimension B is also taken from the lowest part of the mid span sag adjacent to the scaffolding.

Barrier fixed securely to the face of the scaffold. Barrier material must be fit for the intended purpose.

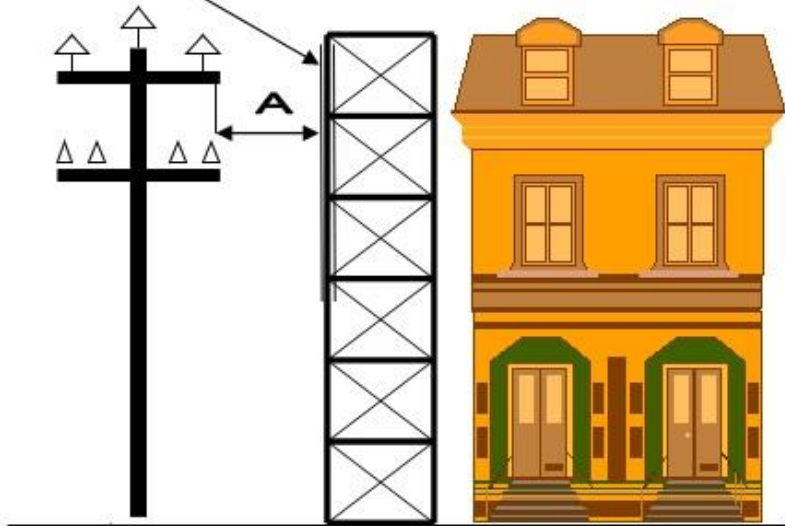

Barrier fixed securely to the face of the scaffold. Barrier material must be fit for the

Barriers and "Live Conductors" warning signs to be placed along

Min 100 mm between pole and scaffolding subject to relevant Local Authority local

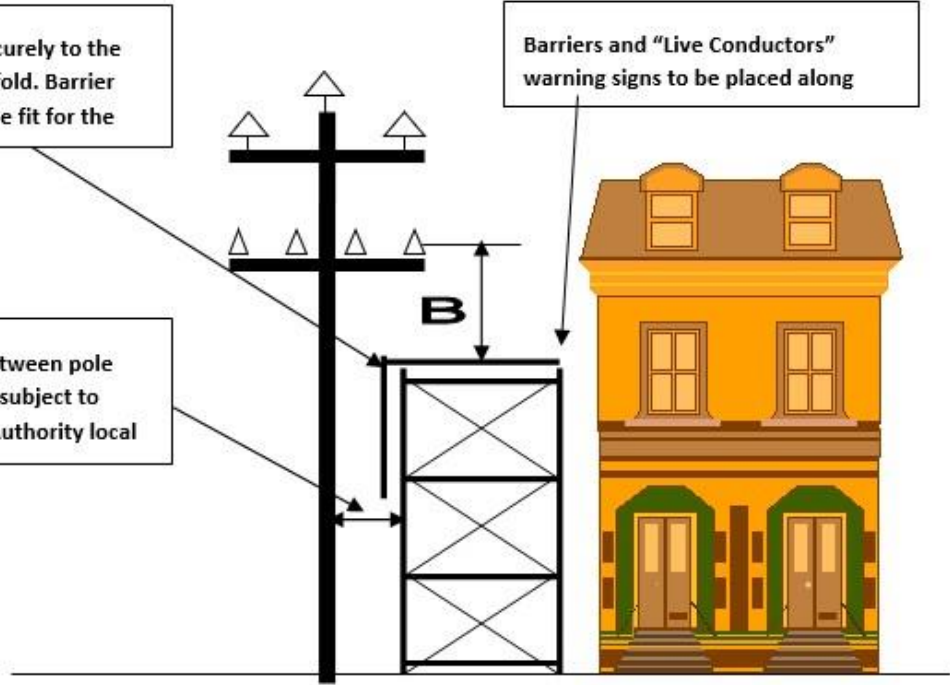

## 2.4. High Load transport under Overhead Electric Lines

Any person or company transporting a High Load (load in excess of 4.6 m high) under overhead electric lines must comply with Electrical Safety Code of Practice 2020 - Working Near Overhead and Underground Electric Lines is required to submit a Notification to Transport High Load form to the relevant Electricity Entity of the intended route and details of the high load involved. Before any person or company can transport a high load (load in excess of 4.6 m high), authorisation to travel must be received in writing from the Electricity Entity. Refer details below to contact the Electricity Entity for high load enquiries or to submit Notification to Transport High Load form:

### Energex:

- **Email:** [custserve@energex.com.au](mailto:custserve@energex.com.au)
- **Website:** [www.energex.com.au](http://www.energex.com.au)
- **Phone:** Energex Contact Centre on 13 12 53 (8am to 5:30pm, Monday to Friday)

### Ergon Energy:

- **Email:** [Highload2@ergon.com.au](mailto:Highload2@ergon.com.au)
- **Website:** [www.ergon.com.au](http://www.ergon.com.au)
- **Phone:** (07) 4932 7566 (8am to 4:30pm, Monday to Friday)

## 2.5. Additional Details and Fact Sheets on Electricity Entity Requirements

Additional details and Fact Sheets on Electricity Entity requirements for working near overhead electric lines are located on the following internet sites

**Energex:** <https://www.energex.com.au/home/safety/working-near-powerlines>

**Ergon Energy:** <https://www.ergon.com.au/network/safety/business-safety/the-outdoor-workplace/working-near-powerlines>

## 3. UNDERGROUND ELECTRICAL ASSETS

### 3.1. Responsibilities When Working in the Vicinity of Electricity Entity Underground Electrical Assets

Everyone has a legal “Duty of Care” that must be observed when working in the vicinity of underground electrical assets which includes underground cables, conduits and other associated underground equipment. When discharging this “Duty of Care” in relation to Electricity Entity underground electrical assets, the following points must be considered:

1. It is the responsibility of the architect, consulting Engineer, developer, and principal contractor in the project planning stages to design for minimal impact and protection of Electricity Entity underground electrical assets. The Electricity Entity will provide plans on request via BYDA showing the presence of the underground electrical assets to assist at this design stage.
2. It is the constructor’s responsibility to:
  - a. Anticipate and request BYDA plans of Electricity Entity underground electrical assets for a particular location at a reasonable time before earthworks begins.
  - b. Visually locate Electricity Entity underground electrical assets by use of an electronic cable locator followed by careful non-mechanical excavation (potholing using hydrovac or hand tools) when earthworks activities may damage or interfere with Electricity Entity plant.

- c. After completion of steps (a) and (b) above, if there is a risk of the Electricity Entity underground electrical assets being damaged or its structural integrity compromised by your planned earthworks activities, contact the Electricity Entity (General Enquiries phone number – refer page 3) for further advice.

A constructor may include but not limited to designer, project manager, installer, contractor, civil contractor.

- 3. The alignments and boundaries contained within BYDA plans and maps will sometimes differ from present alignments and boundaries “on the ground”. Accordingly, in every case, the constructor should obtain confirmation of the actual position of Electricity Entity cables and pipelines under the roadways by non-mechanical excavation (potholing using hydrovac or hand tools) when earthworks activities may damage or interfere with Electricity Entity underground electrical assets. In no case should the constructor rely on statements of third parties in relation to the position of Electricity Entity underground electrical assets.

### 3.2. Conditions of Supply of Information

- Plans and details of Electricity Entity underground electrical assets provided by BYDA are only current for 4 weeks from the date of dispatch and should not be referred to after this period, if you go past this time, please re-apply to BYDA as underground services may have been updated.
- The Electricity Entity agrees to provide plans if an Electricity Entity underground electrical assets location request is made to Before You Dig Australia (BYDA) , online at <https://www.byda.com.au> or the free iPhone Application, only on the basis that at least 2 business day notice is given and the BYDA applicant agrees to the terms of this agreement.



Note that the Electricity Entity only provides information on underground electrical assets it owns. Contact the owner of any privately owned underground electrical assets for details of their assets located at site.

- The Electricity Entity retains copyright of all plans and details provided in connection to your request.
- BYDA plans or other details are provided for the use of the BYDA applicant, its servants, or agents, for the sole purpose of the applicant’s responsibilities in relation to the Electricity Entity underground electrical assets and shall not be used for any other purpose.
- BYDA plans are diagrams only and indicate the presence of Electricity Entity underground electrical assets in the general vicinity of the geographical area shown. Exact ground cover and alignments cannot be given with any certainty as such levels can change over time.
- On receipt of BYDA plans and before commencing excavation work or similar activities near Electricity Entity’s underground electrical assets, carefully locate this plant first to avoid damage.
- The Electricity Entity, its servants or agents shall not be liable for any loss or damage caused or occasioned by the use of plans and of details so supplied to the BYDA applicant, its servants or agents, and the BYDA applicant agrees to indemnify the Electricity Entity against any claim or demand for any such loss or damage to the BYDA applicant, its servants, or agents or to any third party.
- The constructor is responsible for all damages to the Electricity Entity underground electrical assets when work commences prior to obtaining BYDA plans, or at any time after that for failure to follow agreed instructions contained in this document or any other advice provided by the Electricity Entity.
- By undertaking any work, you acknowledge that the Electricity Entity reserves all rights to recover compensation for loss or damage to the Electricity Entity caused by interference or damage, including consequential loss and damage to its cable network, or other property.
- Be aware that some underground conduits may contain asbestos. Refer to “Code of Practice for the Management and Control of Asbestos in Workplace [NOHSC: 2018 (2005)]” for guidance.

### 3.3. When Working in the Vicinity of Electricity Entity Underground Electrical Assets, You Must Observe the Following Conditions

#### 3.3.1 Records

The first step before any excavation commences is to obtain BYDA plans of Electricity Entity underground electrical assets in the vicinity of the work. For new work, records should be obtained during the planning and design stage. The records provided by BYDA must be made available to all relevant work groups on site. Where underground electrical asset information is transferred to plans for the proposed work, care must be exercised that important detail is not lost in the process.

#### 3.3.2 Location of underground electrical assets

Examining the records is not sufficient, as reference points may change from the time of installation. Records must also be physically proven when working in close proximity to underground electrical assets. The exact location of underground electrical assets likely to be affected shall be confirmed by use of an electronic cable locator followed by careful non mechanical excavation to the level of concrete slabs or conduits. Non mechanical excavation (potholing using hydrovac or hand tools) must be used in advance of excavators. In any case, where doubt exists with respect to interpretation of cable records, contact the Electricity Entity (General Enquiries phone number - refer page 3) for further advice.

If during excavation, cables or conduits are damaged:

- call Electricity Entity (Emergencies phone number – refer page 3) to report damaged cables or conduits.
- treat cables as if alive, post a person to keep all others clear of the excavation until the Electricity Entity crew attend to make safe.

If **unknown** cables or conduits (e.g. not shown on issued BYDA plans) are located during excavation:

- call Electricity Entity (Emergencies phone number – refer page 1) to report.
- treat cables as if alive, post a person to keep all others clear of the excavation until the Electricity Entity crew attend to make safe.

If the constructor is unable to locate Electricity Entity underground electrical assets within 2.5 m of nominal plan locations, they should contact the Electricity Entity (General Enquiries phone number - refer page 3) for further advice.

#### 3.3.3 Remote or On-Site Cable Location conducted by Electricity Entity

This service shall only be provided at Electricity Entity's discretion:

- The Electricity Entity may provide this site visit only when underground cables (33 kV or above) are present.
- Due to remote locations where external cable locator or hydro vac service providers are not readily available, Electricity Entity may attend site and assist with cable location (fees may apply for this service).
- The Electricity Entity may provide either remote over the phone or on-site cable location advice to assist in the location of Electricity Entity underground electrical assets, including how to visually locate and protect the plant when excavating.
- Where the Electricity Entity provides on-site cable location advice, any markings provided for the purpose of identifying cable location are for general guidance only, and the constructor is still responsible for non-mechanical excavation (potholing using hydrovac or hand tools) to visually locate Electricity Entity underground electrical assets.
- If the constructor is unable to locate Electricity Entity underground electrical assets within 2.5 m of nominal plan locations, they should contact Electricity Entity (General Enquiries phone number - refer page 3) to request further advice.

### 3.3.4 Electrical Cables

Electricity Entity cables may have warning covers e.g.:

- Clay paving bricks or tiles marked “Electricity” or similar (also unmarked)
- Concrete or PVC cover slabs
- PVC, asbestos or fibro conduit, fibre reinforced concrete, iron or steel pipe
- Concrete encased PVC or steel pipe
- Thin plastic marker tape
- Large pipes housing multiple ducts
- Multiple duct systems, including earthenware or concrete

**NOTE:** Some cables are known to be buried without covers.

### 3.3.5 Separation from Electricity Entity underground electrical assets

If location plans or visual location of Electricity Entity underground electrical assets by non-mechanical excavation (potholing using hydrovac or hand tools) reveals that the location of Electricity Entity underground electrical assets is situated where the developer or constructor plans to work, then contact the Electricity Entity (General Enquiries phone number - refer page 3) for further advice.

The developer or constructor shall ensure that minimum separation distance from Electricity underground electrical assets (refer Minimum Separation Requirements tables below) is complied with when installing, altering or repairing other underground services located in the vicinity.

If the Electricity Entity relocation or protection works are part of the agreed solution, then payment to the Electricity Entity for the cost of this work shall be the responsibility of the principal developer or constructor. The Electricity Entity will provide an estimate for work on receipt of the developer’s or constructor’s order number before work proceeds.

It will be necessary for the developer or constructor to provide the Electricity Entity with a written Work Method Statement for all works in the vicinity of, or involving Electricity Entity underground electrical assets. This Work Method Statement should form part of the tendering documentation and work instruction. All Work Method Statements shall be submitted to the Electricity Entity prior to the commencement of site earthworks.

**Underground Services Running Parallel with Electricity Entity Electrical Assets  
(Minimum Separation required in mm)**

Voltage Level	Gas	Communication or TV	Water		Sanitary drainage		Storm Water
			≤DN 200	>DN200	≤DN 200	>DN 200	
<b>LV</b>	300 (Ergon) 250	100	500	*1000	500	1000	500
<b>HV</b>	(Energex)	300					

\*Contact your local utility/council to obtain specific separation distances

**Underground Services Crossing Electricity Entity Electrical Assets  
(Minimum Separation required in mm)**

Voltage Level	Gas	Communication or TV	Water	Sanitary drainage	Storm Water
<b>LV</b>	100	100	300	300	100
<b>HV</b>					

**Notes:**

- These clearances are each Electricity Entity’s minimum requirements, additional separation may be required by the Service Owner. The greater of the separation requirements shall apply.
- Where the above tables does not list a separation requirement for a particular underground service type, the following minimum separation from electricity entity electrical assets shall apply:
  - LV = 100 mm
  - HV = 300 mm
- Compliance with these minimum separation requirements does not guarantee that issues such as Earth Potential Rise (EPR) and Low Frequency Induction (LFI) are managed, where these issues need to be managed, advice will need to be sought from an RPEQ Engineer
- All separation distances are measured from the exterior surface of the conduit / cable not centrelines or inner wall surfaces.

**Additional Details and Fact Sheets on Electricity Entity Requirements**

Additional details and Fact Sheets on Electricity Entity requirements for working near underground electrical assets are located on the following internet site.

**Energex:** <https://www.energex.com.au/home/safety/working-near-powerlines>

**Ergon Energy:** <https://www.ergon.com.au/network/safety/business-safety/the-outdoor-workplace/working-near-powerlines>

**4. EXCAVATION**

**4.1. Excavating near Poles and Stay Wires**

The following requirements are to be compiled with to minimise the risk of compromising the structural integrity of the Electricity Entity poles and stay foundations when excavation or trenching work is performed nearby that could result in the failure of one or more poles and grounding of supported electric lines.

- Excavation and trenching work undertaken by a person, worker or PCBU in the vicinity of poles and stay foundations shall:
- only be commenced after requirements of Section 3 have been complied with for any underground electrical assets located within the work site.
- upon completion of excavation and site earthworks do not restrict the Electricity Entity vehicle access to pole site for purpose of carrying out maintenance activities.

## PROCEDURE / INSTRUCTIONS

- comply with exclusion zones as detailed in the Electrical Safety Code of Practice 2020 - Working Near Overhead and Underground Electric Lines.
- not be attempted:
  - within 5 m (horizontal distance) of **pole stays** where the excavation depth is greater than 250 mm before contacting the Electricity Entity to determine requirements.
  - within 5 m (horizontal distance) of Electricity Entity poles with earth leads or cables running down into the ground before contacting the Electricity Entity to determine requirements.
  - within “Do Not Disturb” zone of pole prior to a certified engineering assessment having been completed by a Registered Professional Engineer Queensland, and then reviewed and approved by the Electricity Entity before proceeding with work. Approval by the Electricity Entity shall not relieve the PCBU of its duties to perform the work in a safe and proper manner and in accordance with all applicable legislation.
  - if the soil is exceedingly wet (saturated) or there is more than minimal wind loading unless additional pole support is provided in accordance with certified engineering assessment and approved by Electricity Entity.
  - when a severe weather event is occurring or expected (e.g. severe weather warning has been issued by Bureau of Meteorology).
- be backfilled as soon as possible (within same day where pole is required to be supported) soil mechanically compacted in layers of 150 mm and all rock and vegetable material excluded from the backfill.
- be backfilled and pole stabilised before removal of additional support required by a certified engineering assessment are permitted to be removed.

The PCBU shall be responsible for arrangement and costs of required certified engineering assessments, approvals by other regulatory bodies (eg councils, Main Roads pipeline owners, telecomm owns) and installation, maintenance, and removal of associated pole support.

Pole support equipment (where required in accordance with certified engineering assessment) shall be:

- only attached and removed by persons approved by the Electricity Entity.
- used to restrain both the pole head and foot to maintain pole stability during nearby excavation work.
- set up and positioned to maximise support effectiveness and minimise impact on traffic, pedestrian, excavation and machinery at site; and maintain exclusion zone from overhead lines. If insufficient clearance exists to maintain exclusion zone to pole support equipment, arrangements may be required for de-energising the electric line.

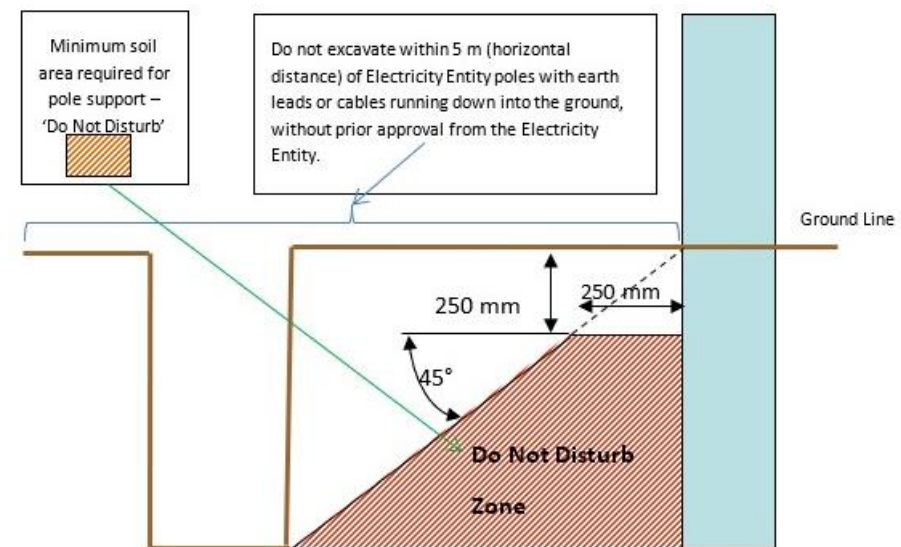

Figure 1 - Do Not Disturb Zone requirements when excavating near poles



Maximum Trench Depth	Minimum Distance from pole without pole support
Not more than 0.25 m (250 mm)	Can trench or hand dig (where cables and leads exist) right up to pole
1.0 m	1.0 m
1.5 m	1.5 m
2.0 m	2.0 m
2.5 m	2.5 m
3.0 m	3.0 m

**4.1.1 Certified Engineering Assessment**

Where required to be provided by the PCBU, a Certified Engineering Assessment shall:

- Ensure the stability of the Electricity Entity poles and foundations is maintained during and as a result of excavation work completed within the ‘Do Not Disturb’ zone.
- Include detailed design drawing of pole support method.
- Be completed and certified by a Registered Professional Engineer Queensland.
- Consider and address the following key points as a minimum:
  - Pole loading (vertical and lateral) including line deviation angles, direction of lean (towards or away from resultant loading)
  - Direction of pole lean.
  - Pole inspection (conducted to meet the Electricity Entity’s requirements at customer cost)
  - Pole foundation depth
  - Proximity of excavation in relation to pole
  - Soil condition
  - Proposed shoring methods as well as installation and removal process
  - Duration and staging of work
  - Requirement to independently support pole during work
  - Proximity of existing adjacent underground services and excavations
  - Proposed backfilling and reinstatement method
  - Monitoring and engineering/ geotechnical supervision during excavation work progress
  - Other equipment attached to pole (e.g. underground cables, transformer, ACR, ABS.) must be taken into consideration and in some circumstances will prevent the pole being supported.

**4.2. Excavating Near Underground Electrical Assets**

For all work within 2.5 m of nominal location, the constructor is required to non-mechanical excavation (potholing using hydrovac or hand tools) and expose the underground electrical assets, hence proving its exact location before earthworks can commence.

#### 4.2.1 Excavating Parallel to Underground Electrical Assets

If excavation work is parallel to the Electricity Entity underground electrical cables, then non mechanical excavation (potholing using hydrovac or hand tools) at least every 4 m is required to establish the location of all cables, hence confirming nominal locations before work can commence. If an excavation exceeds the depth of the cables and it is likely that the covers or bedding material around the cables/pipes will move causing Electricity Entity cables or conduits to be unsupported, contact Electricity Entity (General Enquiries phone number - refer page 3) for further advice.

**NOTE:** Be aware that cable depths and directions may change suddenly along the route.

#### 4.2.2 Excavating Across Underground Electrical Assets

Refer Minimum Separation Requirements table in Section 3.3.5 of this document for distances that shall be maintained to prevent inadvertent contact with or damage to underground electrical assets. If the width or depth of excavation is such that the Electricity Entity cables will be unsupported, contact Electricity Entity (General Enquiries phone number - refer page 3) for further advice. In no case shall a cable cover be removed without approval. A cable cover may only be replaced under the supervision of an Electricity Entity officer. Protective cover strips when removed must be replaced under Electricity Entity supervision. Under no circumstances shall protective cover strips be omitted to achieve the minimum separation distance required between Electricity Entity cables and other underground services.

#### 4.2.3 Heavy Machinery Operation Over Underground Electrical Assets

Where heavy “crawler” or “vibration” type machinery is operated over the top of cables, a minimum cover of 450 mm to the cable protective cover must be maintained. Alternatively, subject to a Certified Engineering Assessment, use load bearing protection whilst the machinery is in operation.

#### 4.2.4 Directional Boring Near Underground Electrical Assets

When boring parallel to cables, it is essential that trial holes are carefully dug using non mechanical excavation (pot holing using hydrovac or hand tools) at regular intervals to prove the actual location of the conduits/cables before using boring machinery. Where it is required to bore across the line of cables/conduits, the actual location of the cables/conduits shall be proven by non-mechanical excavation (pot holing using hydrovac or hand tools). A trench shall be excavated 1 m from the side of the cables where the auger will approach to ensure a minimum clearance of 500 mm from cables/conduits can be maintained.

#### 4.2.5 Hydro Vac Operation

When operating hydro vac equipment to excavate in vicinity of underground electrical assets (cables/conduits):

- Fitted with:
  - nonconductive (neoprene rubber or equivalent) vacuum (suction) hose.
  - oscillating nozzle on pressure wand with water pressure adjusted to not exceeding 2000 psi.
- Maintain a minimum distance of 200 mm between end of pressure wand and underground electrical assets. DO NOT insert the pressure wand jet directly into subsoil.
- Ensure pressure wand is not directly aimed at underground electrical assets (cables / conduits).

### 4.3. Blasting

Explosives must not be used within 5 m of cables/conduits, unless an engineering report is provided indicating that no damage will be sustained. Clearances shall be obtained from the Electricity Entity for use of explosives in the vicinity of cables/conduits. Contact Electricity Entity (General Enquiries phone number - refer page 3) for further advice.

The Electricity Entity will accept the level of 25 mm / sec as a peak component particle velocity upper limit as defined in AS 2187.2 Appendix J for blasting operations in the vicinity of these power lines.

Electric line insulators and conductors are particularly susceptible to damage from fly rock and adequate control measure including the use of blast mats shall be used to manage this. Contact Electricity Entity for consultation and application.

## 5. REPORTING DAMAGE CAUSED TO OVERHEAD OR UNDERGROUND ELECTRIC LINES

Any damage caused to the Electricity Entity overhead electric lines, poles, stays, underground cables, conduits and pipes must be reported no matter how insignificant the damage appears to be. Even very minor damage to cable protective coverings can lead to eventual failure of cables through corrosion of metal sheaths and moisture ingress.

All work in the vicinity of damaged overhead or underground electric lines shall cease and the area be made safe and vacated until clearance to continue earthworks has been obtained from the Electricity Entity. Call Electricity Entity (Emergencies phone number – refer page 3).

## 6. INFRASTRUCTURE NEAR ELECTRIC LINES

### 6.1. Easements and Wayleaves

This information, whilst not a legal document, has been developed to assist the community in answering some commonly asked questions about our easements and wayleaves, and briefly outlines what you can do where land is affected by an easement or where consent to installing electrical infrastructure has been given.

#### 6.1.1 What is an Electricity Easement?

An electricity easement is the authority held by the Electricity Entity to use your land near overhead and underground electric lines and substations (electrical assets). Electricity Entity holds this authority for your own safety and to allow employees access to electrical assets at all times. Whilst it will depend on the terms of the particular grant of easement, electrical easements generally give the Electricity Entity the right to access, maintain, repair, rebuild and to restrict development within a defined area.

The easement, which is registered on the property's title, contains a plan showing the dimensions of the easement and its location on the property together with the rights and restrictions over the easement area. The Department of Natural Resources and Mines <https://www.resources.qld.gov.au/> or your solicitor will be able to provide this information. Easements may also exist for telephone lines, water and sewage mains and natural gas supply lines.

#### 6.1.2 Why are easements necessary?

Easements are also created to allow the Electricity Entity clear, 24 hour access to the electric lines. It is important to keep the easement clear at all times so regular maintenance, line upgrades, damage or technical faults can be attended to immediately to provide a safe and reliable supply of electricity. Interference with Electricity Entity's rights and electrical equipment may compromise safety of the public and the occupiers of the property. Therefore, it is essential that Electricity Entity's rights are understood and observed.

**6.1.3 How do I know if there are easements on my property?**

Contact your solicitor or The Department of Natural Resources and Mines to obtain a Title Search that shows all registered easements on the property.

**6.1.4 Who owns the land the easement is on?**

The ownership of that land encumbered with the easement remains with the property owner.

**6.1.5 How does an easement affect what I can do with my property?**

An easement controls what you can build, what size trees you can plant and what outdoor activities you can carry out in the easement area.

An easement affects the use of the property by limiting the development that can be undertaken within the easement area. The exact rights granted to an Electricity Entity under an electricity easement will depend on the wording used in the grant of easement. Property owners and occupiers should also be aware that an Electricity Entity has the right of access to land to undertake certain works (including reading meters and disconnecting supply). These rights of access are granted by Queensland legislation not the easement and so may not be registered on the property's title and therefore may not be revealed in a Title Search.

**6.1.6 Who is responsible for maintenance of easement area?**

You must provide a continuous, unobstructed area along the full length of the easement to allow an Electricity Entity access to electric lines, transformers, underground cables and other equipment at all times. A width of 4.5 m is typically required for the safe passage of vehicles and heavy plant.

You must NOT place obstructions in the easement within 5 m of any electric lines, transformer, power pole, equipment or supporting wire.

Maintenance of the easement area is generally the responsibility of the property owner and/or occupier, however, complying with regulatory and safety requirements associated with Electricity Entity's electrical assets within the easement area is the responsibility of the Electricity Entity.

**6.1.7 What type of maintenance work does Electricity Entity undertake on easements?**

To enable Electricity Entity to construct, maintain, repair and rebuild electric lines on some properties, access roads and tracks are required on or adjacent to the easement area. As required, Electricity Entity is able to construct access tracks, retain the right of use of these tracks and maintain them to a suitable level to permit access for its vehicles. Where gates are installed within the easement area, an Electricity Entity lock may be required to enable continual access along the easement corridor.

In addition, periodic vegetation management works are also undertaken by Electricity Entity to ensure that a specified minimum clearance between vegetation and the electric lines is maintained.

Where possible, property owners will be contacted prior to easement maintenance and vegetation works commencing.

**6.1.8 Where consent (Wayleave) to installing Electricity Entity infrastructure has been given**

Much of Electricity Entity's above ground electricity network is constructed without easements. Instead, the consent of the owner of the affected land is obtained and the electrical infrastructure is installed. Historically this consent has been in the form of a document known as a Wayleave.

This consent (or Wayleave) is a document evidencing the agreement from a particular owner, but it is not registered on the title of the land like an easement.

Once consent is obtained from an owner, Queensland legislation (the Electricity Act 1994) says that the consent of all future owners to the electrical infrastructure is not required.

Queensland legislation grants Electricity Entity rights to access, maintain, repair and replace electrical assets installed with consent.

## 6.2. Contact Electricity Entity when planning construction work near electric lines

When planning and before commencement (regardless of whether or not local council approval is required), it is essential to confirm that the proposed construction work (e.g. building, structure, sign, crane, scaffold) does not breach the minimum statutory clearance distances that must be maintained from nearby Electricity Entity overhead or underground electric lines. Refer Electrical Safety Regulation 2013, Schedule 4 and 5 for information on statutory clearance distances that must be complied with.

It is extremely dangerous and potentially life threatening to allow anything to come in close proximity to the conductors of an electric line.

Where it is necessary for an Electricity Entity to relocate electric lines due to statutory clearance breach caused by construction work performed nearby, the Electricity Entity is entitled to recover costs from the PCBU, property owner or occupier who caused the breach. Refer Electrical Safety Regulation 2013, Section 209 Building or adding to structure near electric lines.

Although it is preferred that the area around Electricity Entity electrical assets (including within an Easement area) is free of development, the following examples provide property owners and occupiers with an indication of what type of development is acceptable and what is not.

**NOTE:** Do not assume that your local council approval is sufficient approval for you to proceed with your work. The local council may not check whether or not your proposed construction work will comply with the Electricity Entity's statutory clearance requirements

## 6.3. What clearances must be maintained once construction work is completed?

Electrical Safety Regulation 2013, Schedule 4 - Clearance of overhead electric lines and Schedule 5 – Clearance of low voltage overhead service lines detail the statutory clearances that must be maintained from overhead electric lines for completed buildings and structures. These statutory clearances will need to be taken into consideration during the planning phase of determining the location for a building or structure. The table below sets out the minimum statutory clearances required for voltage levels up to 33 kV. Additional requirements may apply for voltage levels above 33 kV, contact the Electricity Entity for consultation.

Where the Electricity Entity has identified a breach of statutory clearance resulting from erection of a building or structure, the statutory breach will be reportable to the Electrical Safety Office as a Dangerous Electrical Event and any costs incurred in subsequent remedial work to achieve required statutory clearances may be recovered from the person or company who caused the breach of statutory clearance.

# PROCEDURE / INSTRUCTIONS

CODE	LOCATION	DIRECTION	INSULATED CABLE (ABC) (Note 1)	BARE	MORE THAN 1000 VOLTS BUT NOT MORE THAN 33kV
------	----------	-----------	--------------------------------	------	---

## MINIMUM CLEARANCE FROM ROADS, GROUND, OR BOUNDARIES

A	Crossing the carriageway, roadway	VERTICALLY	5.5m	5.5m	6.7m
A1	Designated "Over Dimension Routes"	VERTICALLY	7.0m	7.0m	7.5m
B	At other positions, footpath	VERTICALLY	5.5m	5.5m	5.5m
C	Other than roads but trafficable	VERTICALLY	5.5m	5.5m	5.5m
C1	Areas totally inaccessible to traffic or mobile machinery	VERTICALLY	4.5m	4.5m	4.5m
D	Cuttings, embankments, easement boundaries	HORIZONTALLY	1.5m	1.5m	2.1m
X	Real Property Boundaries	HORIZONTALLY	0.0m	0.0m	0.0m

## MINIMUM CLEARANCE FROM STRUCTURES AND BUILDINGS

E F	Unroofed terraces, balconies, sun-decks, paved areas, etc, subject to pedestrian traffic only. A hand rail or wall surrounding such an area and on which a person may stand. (Note)	VERTICALLY AND HORIZONTALLY (Note)	2.7m 1.2m	3.7m 1.5m	4.6m 2.1m
G H	Roofs or similar structures not used for traffic or resort but on which a person may stand. A parapet surrounding such a roof and on which a person may stand. (Note)	VERTICALLY AND HORIZONTALLY (Note)	2.7m 0.9m	3.7m 1.5m	3.7m 2.1m
I	Covered places of traffic or resort such as windows which are capable of being opened, roofed open verandahs and covered balconies.	IN ANY DIRECTION	1.2m	1.5m	2.1m
J	Blank walls, windows which cannot be opened. (Note)	HORIZONTALLY	0.6m	1.5m	1.5m
K L	Other structures not normally accessible to persons. (Note)	VERTICALLY HORIZONTALLY (Note)	0.6m 0.3m	2.7m 1.5m	3.0m 1.5m

### NOTE:

The vertical clearance and the horizontal clearance specified shall be maintained.

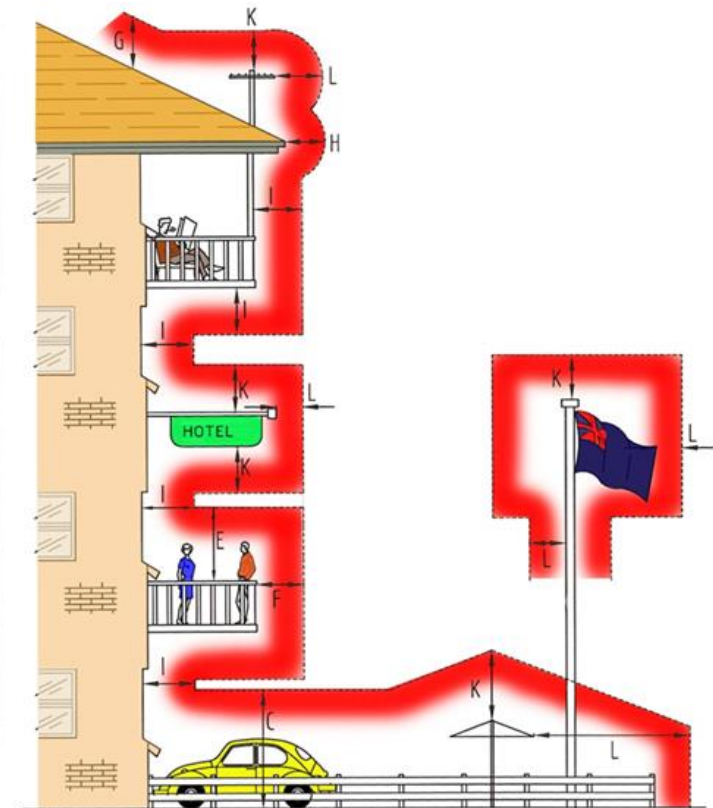

## PROCEDURE / INSTRUCTIONS

The following list of examples is not exhaustive, and it may be necessary to contact the Electricity Entity if doubt exists as to what is permitted around electricity assets.

<b>What is PERMITTED around Electricity Entity overhead or underground electric lines</b>	<b>What is NOT PERMITTED around Electricity Entity overhead or underground electric lines</b>
<ul style="list-style-type: none"> <li>✓ Erection of fences to a maximum height of 2.4 m is generally acceptable, provided they do not affect access to, and work on, the poles, electric lines and/or cables. Trees, shrubs and plants should be located clear of vehicle access. <b>Note:</b> Maximum Growth Height of 3 m.</li> <li>✓ Clothes hoists and barbecues should be located clear of the vehicle access way. <b>Note:</b> Maximum Height 2.5 m.</li> <li>✓ Installation of underground utility services, such as low voltage electricity, gas, telephone and water, is generally acceptable, subject to clearances from Electricity Entity poles and supporting structures, and underground electric mains.</li> <li>✓ Excavating, filling and altering of nearby land may be acceptable but full details need to be provided to the Electricity Entity for assessment.</li> <li>✓ Vehicles, mobile plant and equipment within the easement area need to maintain the minimum statutory clearances distances from overhead electric lines. Normal farming, grazing and other agricultural activities can be carried out. Take care when ploughing or operating mobile machinery or irrigation equipment near Electricity Entity's equipment.</li> <li>✓ Parking of vehicles, trucks, trailers, etc. is normally allowed. <b>Note:</b> Maximum Load and Aerial Height of 4 m. Barriers of an approved design (e.g. bollards) may be required to protect poles from vehicle contact damage. Heavy vehicle or operating plant crossings may need a protective concrete cover to ensure underground cables are not damaged.</li> </ul>	<ul style="list-style-type: none"> <li>✗ Build houses, sheds, garages or other large structures. Building of roofed/ unroofed verandahs, swimming pools and pergolas are generally not acceptable.</li> <li>✗ Flying kites or model aircraft within the easement.</li> <li>✗ Driving fence posts or stakes into ground within easements where there is underground cabling.</li> <li>✗ Storing liquids such as petrol, diesel fuel, or any flammable or combustible material that will burn.</li> <li>✗ Installing lighting poles.</li> <li>✗ Stockpiling soil or garbage within the easement.</li> <li>✗ Planting trees in large quantities that could create a fire hazard or that grow in excess of the approved maximum height of 3 m.</li> <li>✗ Storing or using explosives.</li> <li>✗ Residing in or occupying any caravan or mobile home within an easement.</li> <li>✗ Placing obstructions within the vicinity of any Electricity Entity assets (e.g. power pole, overhead electric line, equipment or pole stay) that impede access to or work on these assets.</li> </ul>

### 6.4. What about Electric and Magnetic Fields?

The Electricity Entity operates its electric lines within the current guidelines set by the National Health and Medical Research Council for exposure to 50/60 hertz electric and magnetic fields (EMF) and is mindful of some community concern about such fields and health. Contact the Electricity Entity (General Enquiries phone number - refer page 3). Alternatively, further information can be sourced from:

Energy Networks Association (ENA) brochure - "Electric and Magnetic Fields - What We Know", January 2014

[http://www.ena.asn.au/sites/default/files/emf-what-we-know-jan-2014-final\\_1\\_1.pdf](http://www.ena.asn.au/sites/default/files/emf-what-we-know-jan-2014-final_1_1.pdf)

Australian Radiation Protection and Nuclear Safety Agency (ARPANSA) brochure - "Electricity and Health", May 2011

[http://www.arpansa.gov.au/RadiationProtection/Factsheets/is\\_electricity.cfm](http://www.arpansa.gov.au/RadiationProtection/Factsheets/is_electricity.cfm)

DEFINITIONS	
Term	Definition
Applicant	A person contacting or applying to the Electricity Entity for a Safety Advice.
Authorised Person	For work near an electrical line, means a person who has enough technical knowledge and experience to do work that involves being near to the electrical line; and has been approved by the person in control of the electrical line (Electricity Entity) to do work near to the electrical line.
Authorised Person (Electrical)	An Electrical Mechanic or Electrical Linesperson (holding current Queensland Licence) working on behalf of an electrical contractor and accredited with the Electricity Entity who is permitted to remove and replace LV service fuse(s) when isolation of customer LV service line is required to eliminate the exclusion zone around the LV service line, or to work on the customer's mains and / or switchboard.
Earthworks	Any digging, penetration or disturbance of ground including but not limited to post hole digging, excavating, trenching, directional boring, bore hole sinking, driving pickets/posts into ground, cut and fill, dam or levee bank construction, blasting.
Electricity Entity	Where Electricity Entity appears throughout this document, it relates to either Energex or Ergon Energy area of responsibility. Refer to respective contact details below.
Instructed Person	For an electrical line, means a person who is acting under the supervision of an Authorised Person for the electrical line.
Safety Advice	A written notice identifying the known electrical hazards at a specific site and advising the control measures required to be implemented by Responsible Person (person responsible for worksite) to reduce the likelihood of harm to person, plant or vehicle at site.
Safety Observer	<p>A safety observer or "spotter", for the operation of operating plant, means a person who:</p> <ul style="list-style-type: none"> <li>(a) observes the operating plant; and</li> <li>(b) advises the operator of the operating plant if it is likely that the operating plant will come within an exclusion zone for the operating plant for an overhead electric line.</li> </ul> <p>This is a person who has undergone specific training and is competent to perform the role in observing, warning and communicating effectively with the operator of the operating plant.</p>
Untrained Person	For an electrical line, means a person who is not an Authorised Person or an Instructed Person for the electrical line.

## TRAINING

Staff must be current in all Statutory Training relevant for the task.



## SAFETY / ENVIRONMENTAL CONTROLS

Follow the Safety Policy, procedures and practices set out for Energy Queensland and subsidiary companies.

Personnel are responsible for understanding all the risks and ensuring their individual actions do not endanger the health and safety of themselves or others.



## FATAL HAZARDS CRITICAL CONTROLS FOR THE TASK



## REFERENCES

### Supporting Documents

Electrical Safety Regulation 2013: Part 5 - Overhead and Underground Electric Lines

Electrical Safety Code of Practice 2020 - Working Near Overhead and Underground Electric Lines

Work Health and Safety Act 2011

Work Health and Safety Regulation 2011

### Energex documents:

- Application for Safety Advice – Working near Energex exposed live parts
- Important Notice – Working near Energex Power Lines Including Overhead Services
- Safety Advice on working near Energex exposed live parts

### Ergon Energy documents:

- Safety Advice Request Form
- Safety Advice on Working around Electrical Parts Form
- Important Notice Regarding Safety Advice QRG

Copies of the relevant Acts, Regulation and Codes of Practice and any other relevant legislation can be found on the Queensland Government web site - <https://www.worksafe.qld.gov.au/>

## REFERENCES

### Disclaimer

This document refers to various standards, guidelines, calculations, legal requirements, technical details and other information and is not an exhaustive list of all safety matters that need to be considered.

Over time, changes in industry standards and legislative requirements, as well as technological advances and other factors relevant to the information contained in this document, may affect the accuracy of the information contained in this document. Whilst care is taken in the preparation of this material, Energex and Ergon Energy do not guarantee the accuracy and completeness of the information. Accordingly, caution should be exercised in relation to the use of the information in this document.

To the extent permitted by law, Energex and Ergon Energy will not be responsible for any loss, damage or costs incurred as a result of any errors, omissions or misrepresentations in relation to the material in this document or for any possible actions ensuing from information contained in the document.

## TABLE OF CONTENTS

### CONTENTS

1.	ABOUT THIS GUIDE .....	2
1.1.	Who does the Electrical Safety Code of Practice 2020 - Working Near Overhead and Underground Electric Lines and Electricity Entity Requirements apply to? .....	2
1.2.	Are you working or planning to work near overhead or underground electric lines? .....	2
1.2.1	Work near overhead electric lines .....	3
1.2.2	Exclusion Zones .....	3
1.2.3	Work near underground electrical lines (underground electrical assets) .....	5
1.3.	Obtaining Safety Advice.....	5
1.4.	Authorised Person and how to become one?.....	6
1.5.	Contacting Electricity Entity for Safety Advice or Authorised Person Enquiries .....	6
2.	OVERHEAD ELECTRIC LINES .....	7
2.1.	Isolation of supply to customer installation to eliminate exclusion zone around LV service line .....	8
2.2.	Operating Plant.....	8
2.3.	Scaffolding Requirements .....	9
2.4.	High Load transport under Overhead Electric Lines .....	12
2.5.	Additional Details and Fact Sheets on Electricity Entity Requirements.....	12
3.	UNDERGROUND ELECTRICAL ASSETS.....	12
3.1.	Responsibilities When Working in the Vicinity of Electricity Entity Underground Electrical Assets.....	12
3.2.	Conditions of Supply of Information .....	13
3.3.	When Working in the Vicinity of Electricity Entity Underground Electrical Assets, You Must Observe the Following Conditions.....	14

## TABLE OF CONTENTS

3.3.1	Records .....	14
3.3.2	Location of underground electrical assets .....	14
3.3.3	Remote or On-Site Cable Location conducted by Electricity Entity .....	14
3.3.4	Electrical Cables .....	15
3.3.5	Separation from Electricity Entity underground electrical assets .....	15
4.	EXCAVATION.....	16
4.1.	Excavating near Poles and Stay Wires .....	16
4.1.1	Certified Engineering Assessment .....	18
4.2.	Excavating Near Underground Electrical Assets .....	18
4.2.1	Excavating Parallel to Underground Electrical Assets .....	19
4.2.2	Excavating Across Underground Electrical Assets .....	19
4.2.3	Heavy Machinery Operation Over Underground Electrical Assets .....	19
4.2.4	Directional Boring Near Underground Electrical Assets .....	19
4.2.5	Hydro Vac Operation .....	19
4.3.	Blasting.....	20
5.	REPORTING DAMAGE CAUSED TO OVERHEAD OR UNDERGROUND ELECTRIC LINES.....	20
6.	INFRASTRUCTURE NEAR ELECTRIC LINES.....	20
6.1.	Easements and Wayleaves.....	20
6.1.1	What is an Electricity Easement?.....	20
6.1.2	Why are easements necessary?.....	20
6.1.3	How do I know if there are easements on my property?.....	21
6.1.4	Who owns the land the easement is on? .....	21
6.1.5	How does an easement affect what I can do with my property?.....	21
6.1.6	Who is responsible for maintenance of easement area?.....	21
6.1.7	What type of maintenance work does Electricity Entity undertake on easements?.....	21
6.1.8	Where consent (Wayleave) to installing Electricity Entity infrastructure has been given.....	21
6.2.	Contact Electricity Entity when planning construction work near electric lines.....	22
6.3.	What clearances must be maintained once construction work is completed?.....	22
6.4.	What about Electric and Magnetic Fields? .....	24



## **Responsibilities – (When Working in the Vicinity of Energex Assets)**

Extreme care must be taken during non-mechanical or mechanical excavation as damage to Energex Assets can lead to injury or death of workers or members of the public. Assets include underground cables, conduits and other associated underground Asset used for controlling, generating, supplying, transforming or transmitting electricity.

In accordance with the Electrical Safety Act 2002, a Person Conducting a Business or Undertaking (PCBU) must ensure the person's business or undertaking is conducted in a way that is electrically safe. This includes:

- a) ensuring that all Assets used in the conduct of the person's business or undertaking are electrically safe;
- b) if the person's business or undertaking includes the performance of electrical work, ensuring the electrical safety of all persons and property likely to be affected by the electrical work; and
- c) if the person's business or undertaking includes the performance of work, whether or not electrical work, involving contact with, or being near to, exposed parts, ensuring persons performing the work are electrically safe.

In addition, a PCBU at a workplace must ensure, so far as is reasonably practicable, that no person, Asset or thing at the workplace comes within an unsafe distance of an underground electric line.

Workers and other persons must also take reasonable care for their own and other person's electrical safety. This includes complying, so far as is reasonably able, with any reasonable instructions given by Energex to ensure compliance with the [Electrical Safety Act 2002](#)

General enquiries (7:00am - 5:30pm Mon to Fri) [13 12 53](tel:131253)  
Life threatening emergencies only triple zero (000) or [13 19 62](tel:131962)

To re-submit or change the nominated search area please visit [BYDA.com.au](http://BYDA.com.au)

E: [custserve@energex.com.au](mailto:custserve@energex.com.au)

E: [byda@energyq.com.au](mailto:byda@energyq.com.au)

ABN: 40 078 849 055



The following matters must be considered when working near Energex Assets:

The PCBU must ensure, so far as is reasonably practicable, that no person, Asset or thing at the workplace comes within an unsafe distance of an underground electric line (see section 68 of the [Electrical Safety Regulation 2013](#))

1. It is the responsibility of the architect, consulting engineer, developer and head contractor in the project planning stages to design for minimal impact and protection of Energex Assets.
2. It is the constructor's responsibility to:
  - a) Anticipate and request plans of Energex Assets for a location at a reasonable time before construction begins.
  - b) Visually locate Energex Assets by hand or vacuum excavation where construction activities may damage or interfere with Energex Assets.
  - c) notify Energex if the information provided is found to be not accurate or Assets are found on site that are not recorded on the Energex BYDA plans.
  - d) Read and understand all the information and disclaimers provided.

**Note:** A constructor may include but not limited to a PCBU, Designer, Project Manager, Installer, Contractor, Electrician, Builder, Engineer or a Civil Contractor

3. Comply with applicable work health and safety and electrical safety codes of practice including but not limited to:
  - a) Working near Assets – [Electrical safety codes of practice 2020](#)
  - b) Managing electrical risk in the workplace – [Managing Electrical Risks in the workplace Code of Practice 2021](#)
  - c) [Excavation work – Code of practice 2021](#)

#### IMPORTANT NOTES:

- As the alignment and boundaries of roadways with other properties (and roads within roadways) frequently change, the alignments and boundaries contained within Energex plans and maps will frequently differ from present alignments and boundaries "on the ground". Accordingly, in every case where it appears that alignments and boundaries have shifted, or new roadways have been added, the constructor should obtain confirmation of the actual position of Energex cables and pipelines under the roadways. In no case should the constructor rely on statements of third parties in relation to the position of Energex cables and pipelines. It is the applicant's responsibility to accurately locate all services as part of the design and/or prior to excavation.
- Energex does not provide information on private underground installations, including consumers' mains that may run from Energex mains onto private property. Assets located on private property are the responsibility of the owner for identification and location.
- Energex plans are circuit diagrams or pipe indication diagrams only and indicate the presence of Asset in the general vicinity of the geographical area shown. Exact ground cover and alignments cannot be given with any certainty; as such levels can change over time.
- All underground conduits are presumed to contain asbestos. Refer to the:
  - [Electrical safety codes of practice 2020](#)
  - [Model Code of Practice: How to manage and control asbestos in the workplace | Safe Work Australia](#)
  - [How to manage and control asbestos in the workplace code of practice 2021 \(Workplace Health and Safety Queensland \(WHSQ\)\)](#)
  - [How to safely remove asbestos code of practice 2021 \(WHSQ\)](#)
- Plans provided by Energex are not guaranteed to show the presence of above ground Assets.
- In addition to underground cables marked on attached plan there could be underground substation, underground earth conductors, Multiple Earthed Neutral(MEN) conductors, Single Wire Earth Return(SWER), substation Earth Conductors, ABS Earth Mats or Consumer Mains in the vicinity or private underground cables (inc. consumers' mains that may run from Energex mains onto private property) in the vicinity of the nominated work area(s) that are not marked on the plans.
- Being aware of Your obligations including but not limited to [ss 304, 305] Excavation work— underground essential services information under the [Work Health and Safety Regulation 2011](#) , Chapter 6 Construction work, Part 6.3 Duties of person conducting business or undertaking. This includes but is not limited to taking reasonable steps to obtain the current information & providing this information to persons engaged to carry out the excavation work. For further information please refer to: - <http://www.legislation.qld.gov.au/LEGISLTN/SLS/2011/11SL240.pdf>
- Energex plans are designed to be printed in colour and as an A3 Landscape orientation.

General enquiries (7:00am - 5:30pm Mon to Fri) [13 12 53](tel:131253)  
Life threatening emergencies only triple zero (000) or [13 19 62](tel:131962)

To re-submit or change the nominated search area please visit [BYDA.com.au](http://BYDA.com.au)

E: [custserve@energex.com.au](mailto:custserve@energex.com.au)

E: [byda@energex.com.au](mailto:byda@energex.com.au)

ABN: 40 078 849 055



## **Conditions – (When Working in the Vicinity of Energex Assets)**

### **Records:**

The first step before any excavation commences is to obtain records of Energex Assets in the vicinity of the work. For new work, records should be obtained during the planning and design stage. The records provided by Energex must be made available to all construction groups on site. Where Asset information is transferred to plans for the proposed work, care must be exercised to ensure that important detail is not lost in the process.

**Plans and or details provided by Energex are current for four weeks from the date of dispatch** and should be disposed of by shredding or any other secure disposal method after use. A new BYDA enquiry must be made for proposed works/activities to be undertaken outside of the four-week period.

Energex retains copyright of all plans and details provided in connection with Your request.

Energex plans or other details are provided for the use of the applicant, its servants, or agents, and shall not be used for any unauthorised purpose.

On receipt of BYDA plans and before commencing excavation work or similar activities near Energex's Assets check to see that it relates to the area You have requested and carefully locate this Asset first to avoid damage. If You are unclear about any information contained in the plan, You must contact Energex on the General Enquiries number listed below for further advice.

Energex, its servants or agents shall not be liable for any loss or damage caused or occasioned by the use of plans and or details so supplied to the applicant, its servants and agents, and the applicant agrees to indemnify Energex against any claim or demand for any such loss or damage.

The contractor is responsible for all Asset damages when works commence prior to obtaining Energex plans, or failure to follow agreed instructions, or failure to demonstrate all reasonable measures were taken to prevent the damage once plans were received from Energex.

Energex reserves all rights to recover compensation for loss or damage caused by interference or damage, including consequential loss and damages to its Assets, or other property.

**NOTE:** Where Your proposed work location contains Energex 33kV or greater Underground cables please access the [Energex BYDA website](#) for more information.

### **Location of Assets:**

Examining the records is not sufficient, as reference points may change from the time of installation. Records must also be physically proven when working in close proximity to them. The exact location of Assets likely to be affected shall be confirmed by use of an electronic cable and pipe locator followed by **careful hand or vacuum excavation to the level of cable protection cover strips or conduits**. When conducting locations, please be aware that **no** unauthorised access is permitted to Energex Assets– including Pits, Low Voltage Disconnection Boxes, Low Voltage Pillars or High Voltage Link Boxes.

**Hand or vacuum excavation must be used in advance of excavators.** In any case, where any doubt exists with respect to interpretation of cable records, You must contact Energex on the General Enquires number listed below for further advice.

If the constructor is unable to locate Energex underground Assets within 5 metres of nominal plan locations, they must contact the Energex General Enquires number listed below for further advice.

If unknown cables or conduits (i.e. not shown on issued BYDA plans) are located during excavation:

1. Call the ELECTRICITY EMERGENCIES number listed below
2. Treat Assets as if alive, post a person to keep all others clear of the excavation until Energex crew attend to make safe.
3. All work in the vicinity of damaged Asset must cease and the area must be vacated until a clearance to continue work has been obtained from an Energex officer.

General enquiries (7:00am - 5:30pm Mon to Fri) [13 12 53](tel:131253)  
Life threatening emergencies only triple zero (000) or [13 19 62](tel:131962)

To re-submit or change the nominated search area please visit [BYDA.com.au](http://BYDA.com.au)

E: [custserve@energex.com.au](mailto:custserve@energex.com.au)

E: [byda@energyq.com.au](mailto:byda@energyq.com.au)

ABN: 40 078 849 055



**Asset Installation Methods:**

Energex Assets are installed with a variety of protection devices including:

1. Clay paving bricks or tiles marked "Electricity" or similar (also unmarked)
2. Concrete or PVC cover slabs
3. PVC, A/C or fibro conduit, fibre reinforced concrete, iron or steel pipe
4. Concrete encased PVC or steel pipe
5. Thin plastic marker tape
6. Large pipes housing multiple ducts
7. Multiple duct systems, including earthenware or concrete 2, 4, and 6-way ducts and shamrocks

*Note: Some Assets are known to be buried without covers and may change depth or alignment along the route.*

**Excavating Near Assets:**

For all work within 2.5 m of nominal location, the constructor is required to hand or vacuum excavate (pothole) and expose the Asset, hence proving its exact location before work can commence.

Cable protection cover strips shall not be disturbed. Excavation below these cover strips, or into the surrounding backfill material is not permitted.

**Excavating Parallel to Assets:**

If construction work is parallel to Energex cables, then hand or vacuum excavation (potholing) at least every 4m is required to establish the location of all cables, hence confirming nominal locations before work can commence. *Generally, there is no restriction to excavations parallel to Energex cables to a depth not exceeding that of the cable. Note: Cable depths & alignment may change suddenly.*

**Separation from Assets:**

Any service(s) must be located at the minimum separation as per the tables below:

**Table 1. Minimum Separation Requirements for Underground Services Running Parallel with Energex Assets**

(Minimum Separation required in mm)							
Voltage Level	Gas	Communication or TV	Water		Sanitary drainage		Storm Water
			≤DN 200	>DN200	≤DN 200	>DN 200	
LV	250	100	500	*1000	500	1000	500
HV		300					
*Contact Energex/council to obtain specific separation distances							

**Table 2. Minimum Separation Requirements for Underground Services Crossing Energex Assets**

(Minimum Separation required in mm)					
Voltage Level	Gas	Communication or TV	Water	Sanitary drainage	Storm Water
LV & HV	100	100	300	300	100

Where the above table does not list a separation requirement for a particular underground service then 300mm shall be used.

**Excavating Across Assets:**

The standard clearance between services shall be maintained as set down in Table 2 above. If the width or depth of the excavation is such that the Asset will be exposed or unsupported, then Energex shall be contacted to determine whether the Assets should be taken out of service, or whether they need to be protected or supported. In no case shall an Asset cover be removed without approval. An Asset cover may only be removed under the supervision of an Energex authorised representative. Protective cover strips when removed must be replaced under Energex supervision. Under no circumstances shall they be omitted to allow separation between Energex Assets and other services.

General enquiries (7:00am - 5:30pm Mon to Fri) [13 12 53](tel:131253)  
 Life threatening emergencies only triple zero (000) or [13 19 62](tel:131962)

To re-submit or change the nominated search area please visit [BYDA.com.au](http://BYDA.com.au)

E: [custserve@energex.com.au](mailto:custserve@energex.com.au)

E: [byda@energex.com.au](mailto:byda@energex.com.au)

ABN: 40 078 849 055



### Heavy Machinery Operation Over Assets:

Where heavy "Crawler" or "Vibration" type machinery is operated over the top of Assets, a minimum cover of 450 mm to the cable protective cover mains must be maintained using load bearing protection whilst the machinery is in operation. For sensitive cables (i.e. 33 and 110kV fluid and gas filled cables), there may be additional constraints placed on vibration and settlement by Energex.

### Directional Boring Near Assets:

When boring parallel to Assets, it is essential that trial holes are carefully hand or vacuum excavated at regular intervals to prove the actual location of the Asset before using boring machinery. Where it is required to bore across the line of Assets, the actual location of the Asset shall first be proven by hand or vacuum excavation. A trench shall be excavated 1m from the side of the Asset where the auger will approach to ensure a minimum clearance of 500mm above and below all LV, 11kV, 33kV & 110/132kV Asset shall be maintained.

### Explosives:

*Explosives must not be used within 10 metres of Assets*, unless an engineering report is provided indicating that no damage will be sustained. Clearances should be obtained from Energex's Planning Engineer for use of explosives in the vicinity of Energex cables.

### Damage Reporting:

All damage to Assets must be reported no matter how insignificant the damage appears to be. Even very minor damage to Asset protective coverings can lead to eventual failure of Assets through corrosion of metal sheaths and moisture ingress.

If any Damaged Asset is found:

1. Call the ELECTRICITY EMERGENCIES number listed below
2. Treat Assets as if alive, post a person to keep all others clear of the excavation until Energex crew attend to make safe.
3. All work in the vicinity of damaged Asset must cease and the area must be vacated until a clearance to continue work has been obtained from an Energex officer.

### Solutions and Assistance:

If Asset location plans or visual location of Asset by hand or vacuum excavation reveals that the location of Energex Asset is situated wholly or partly where the developer or constructor plans to work, then Energex shall be contacted to assist with Your development of possible engineering solutions.

If Energex relocation or protection works are part of the agreed solution, then payment to Energex for the cost of this work shall be the responsibility of the, PCBU, principal developer or constructor. Energex will provide an estimated quotation for work on receipt of the PCBU's, developer's or constructor's order number before work proceeds.

It will be necessary for the developer or constructor to provide Energex with a written Safe Work Method Statement for all works in the vicinity of or involving Energex Assets. This Safe Work Method Statement should form part of the tendering documentation and work instruction. Refer Interactive Tool on Safe Work Australia site: [Interactive SWMS guidance tool - Overview \(safeworkaustralia.gov.au\)](https://www.safeworkaustralia.gov.au/interactive-swms-guidance-tool-overview)

### Vacuum Excavations (Hydro Vac)

When operating hydro vac equipment to excavate in vicinity of Assets fitted with:

- Nonconductive (neoprene rubber or equivalent) vacuum (suction) hose
- Oscillating nozzle on pressure wand with water pressure adjusted to not exceeding 2000 Pound force per Square Inch(PSI).

Maintain a minimum distance of 200mm between end of pressure wand and underground electrical Assets. DO NOT insert the pressure wand jet directly into subsoil.

Ensure pressure wand is not directly aimed at underground electrical Assets (cables/conduits).

### Safety Notices (Underground Work)

It is recommended that You obtain a written Safety Advice from Energex when working close to Energex Assets. For Safety Advice please contact [custserve@energex.com.au](mailto:custserve@energex.com.au)

**Further information on Working Safely around Energex Assets:** [Working near powerlines | Energex](#)

*Thank You for Your interest in maintaining a safe and secure Electricity Distribution network. Energex welcomes Your feedback on this document via email to [byda@energyq.com.au](mailto:byda@energyq.com.au).*

General enquiries (7:00am - 5:30pm Mon to Fri) [13 12 53](tel:131253)  
Life threatening emergencies only triple zero (000) or [13 19 62](tel:131962)

To re-submit or change the nominated search area please visit [BYDA.com.au](https://www.byda.com.au)

E: [custserve@energex.com.au](mailto:custserve@energex.com.au)

E: [byda@energyq.com.au](mailto:byda@energyq.com.au)

ABN: 40 078 849 055





**Referral**  
248885696

**Member Phone**  
1800 687 626

## Responses from this member

**Response received** Tue 17 Dec 2024 5.28pm

<b>File name</b>	<b>Page</b>
Response Body	98
248885696_20241217_092739013982_1.pdf	99
248885696_20241217_092739013982_pwc_1.pdf	102
Disclaimer_248885696_20241217_092739013982.pdf	105
4678_NBN_Dial_Before_You_Dig_Poster_20170517.pdf	109

Hi Abigail Mercado,

Please find attached the response to your DBYD referral for the address mentioned in the subject line. The location shown in our DBYD response is assumed based off the information you have provided. If the location shown is different to the location of the excavation then this response will consequently be rendered invalid.

Take the time to read the response carefully and note that this information is only valid for 28 days after the date of issue.

If you have any further enquiries, please do not hesitate to contact us.

Regards,  
Network Services and Operations  
NBN Co Limited  
P: 1800626329  
E: [dbyd@nbnco.com.au](mailto:dbyd@nbnco.com.au)  
[www.nbnco.com.au](http://www.nbnco.com.au)

#### Confidentiality and Privilege Notice

This e-mail is intended only to be read or used by the addressee. It is confidential and may contain legally privileged information. If you are not the addressee indicated in this message (or responsible for delivery of the message to such person), you may not copy or deliver this message to anyone, and you should destroy this message and kindly notify the sender by reply e-mail. Confidentiality and legal privilege are not waived or lost by reason of mistaken delivery to you. Any views expressed in this message are those of the individual sender, except where the sender specifically states them to be the views of NBN Co Limited

Please Do Not Reply To This Mail

**To:** Abigail Mercado  
**Phone:** Not Supplied  
**Fax:** Not Supplied  
**Email:** property1@ilookproperty.com.au

<b>Dial before you dig Job #:</b>	38295369	 <b>BEFORE YOU DIG</b> www.byda.com.au Zero Damage - Zero Harm
<b>Sequence #</b>	248885696	
<b>Issue Date:</b>	17/12/2024	
<b>Location:</b>	5 Teasel Cr , Forest Lake , QLD , 4078	

**Indicative Plans are tiled below to demonstrate how to layout and read nbn asset plans**

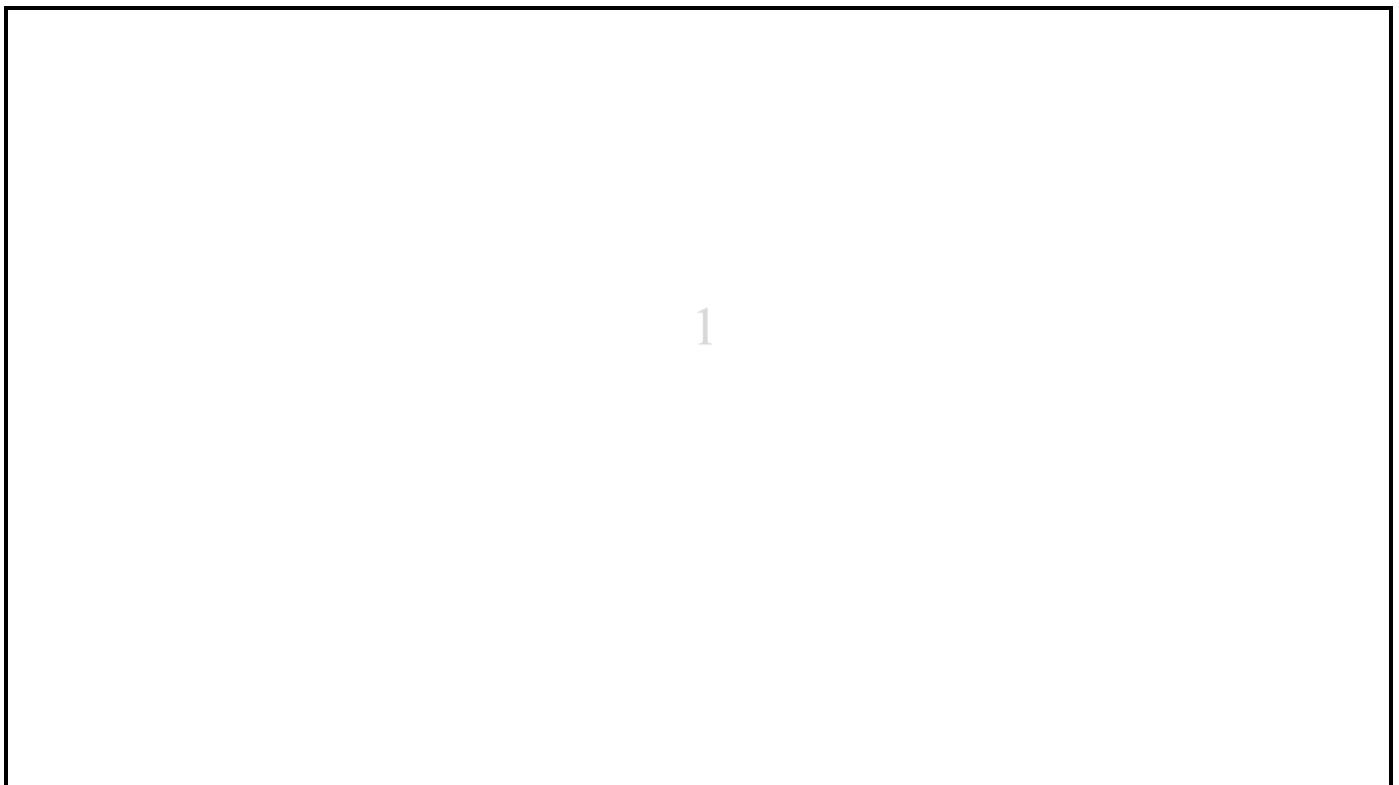



## LEGEND



	Parcel and the location
	Pit with size "5"
	Power Pit with size "2E". Valid PIT Size: e.g. 2E, 5E, 6E, 8E, 9E, E, null.
	Manhole
	Pillar
	Cable count of trench is 2. One "Other size" PVC conduit (PO) owned by Telstra (-T-), between pits of sizes, "5" and "9" are 25.0m apart. One 40mm PVC conduit (P40) owned by NBN, between pits of sizes, "5" and "9" are 20.0m apart.
	2 Direct buried cables between pits of sizes, "5" and "9" are 10.0m apart.
	Trench containing any <b>INSERVICE/CONSTRUCTED</b> (Copper/RF/Fibre) cables.
	Trench containing only <b>DESIGNED/PLANNED</b> (Copper/RF/Fibre/Power) cables.
	Trench containing any <b>INSERVICE/CONSTRUCTED</b> (Power) cables.
	Road and the street name "Broadway ST"
Scale	0 20 40 60 Meters 1:2000 1 cm equals 20 m 

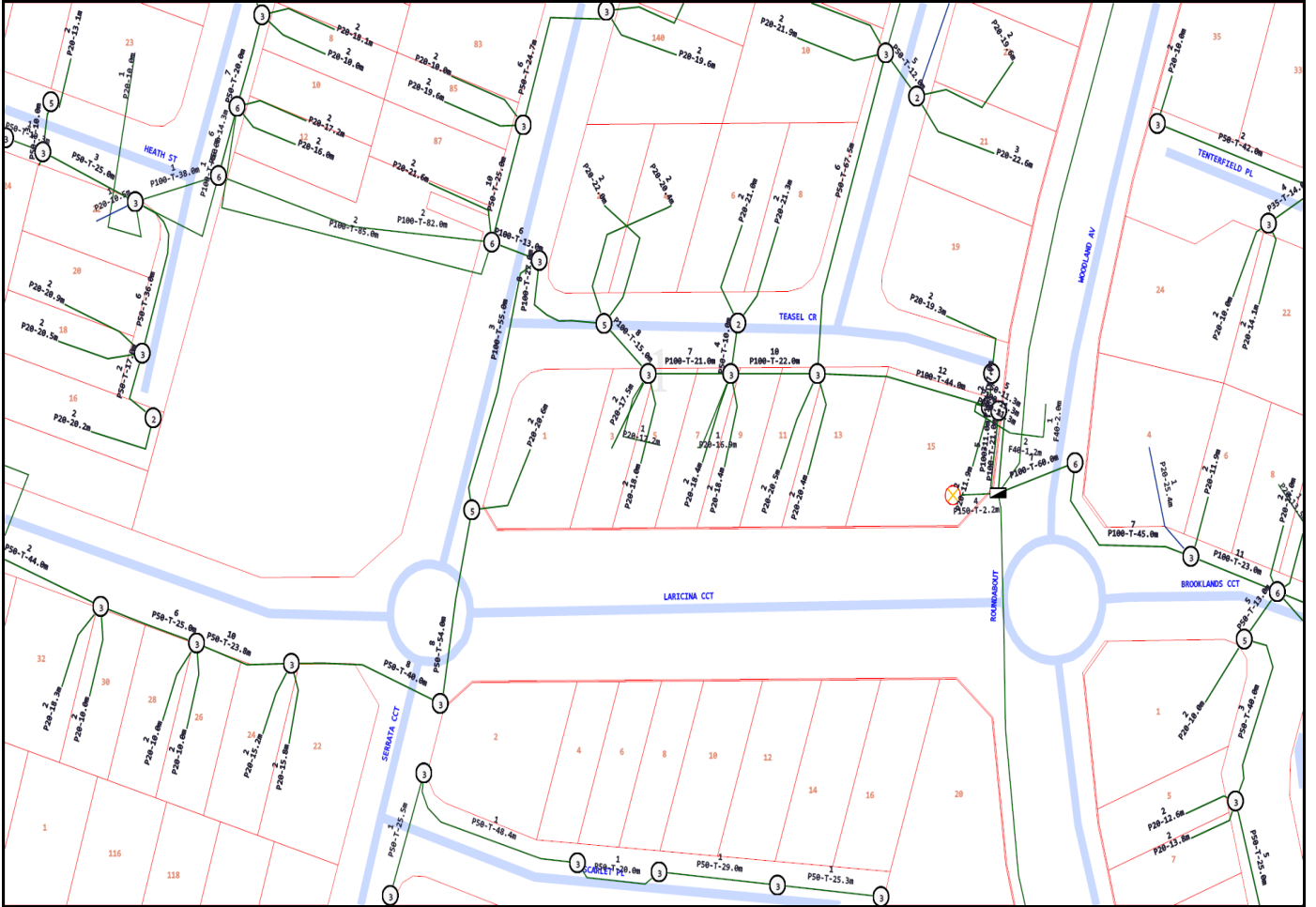

## Emergency Contacts

You must immediately report any damage to the **nbn™** network that you are/become aware of. Notification may be by telephone - 1800 626 329.

**To:** Abigail Mercado  
**Phone:** Not Supplied  
**Fax:** Not Supplied  
**Email:** property1@ilookproperty.com.au

<b>Dial before you dig Job #:</b>	38295369	
<b>Sequence #</b>	248885696	
<b>Issue Date:</b>	17/12/2024	
<b>Location:</b>	5 Teasel Cr , Forest Lake , QLD , 4078	

**Indicative Plans are tiled below to demonstrate how to layout and read nbn asset plans**

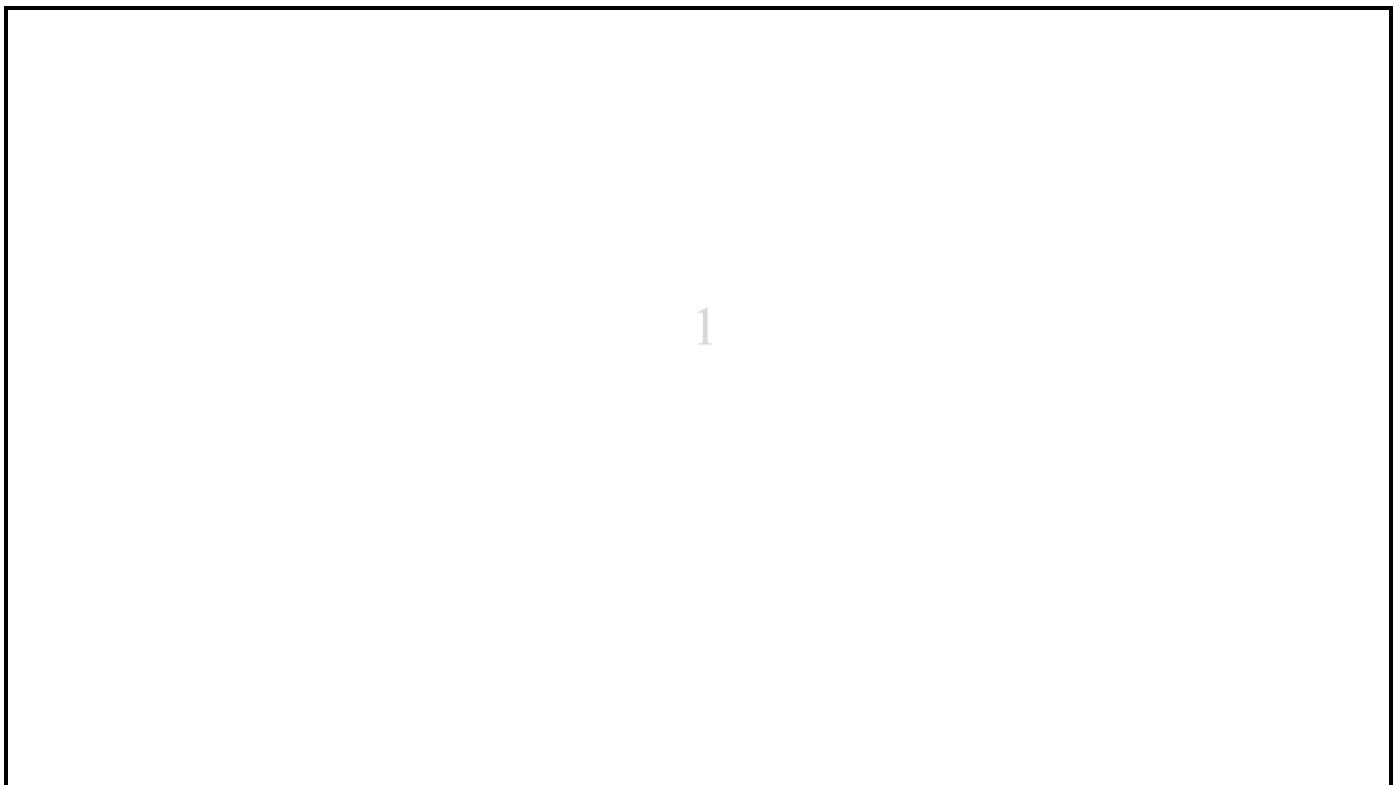



## LEGEND



	Parcel and the location
	Pit with size "5"
	Power Pit with size "2E". Valid PIT Size: e.g. 2E, 5E, 6E, 8E, 9E, E, null.
	Manhole
	Pillar
	Cable count of trench is 2. One "Other size" PVC conduit (PO) owned by Telstra (-T-), between pits of sizes, "5" and "9" are 25.0m apart. One 40mm PVC conduit (P40) owned by NBN, between pits of sizes, "5" and "9" are 20.0m apart.
	2 Direct buried cables between pits of sizes, "5" and "9" are 10.0m apart.
	Trench containing any <b>INSERVICE/CONSTRUCTED</b> (Copper/RF/Fibre) cables.
	Trench containing only <b>DESIGNED/PLANNED</b> (Copper/RF/Fibre/Power) cables.
	Trench containing any <b>INSERVICE/CONSTRUCTED</b> (Power) cables.
	Road and the street name "Broadway ST"
Scale	0 20 40 60 Meters 1:2000 1 cm equals 20 m 

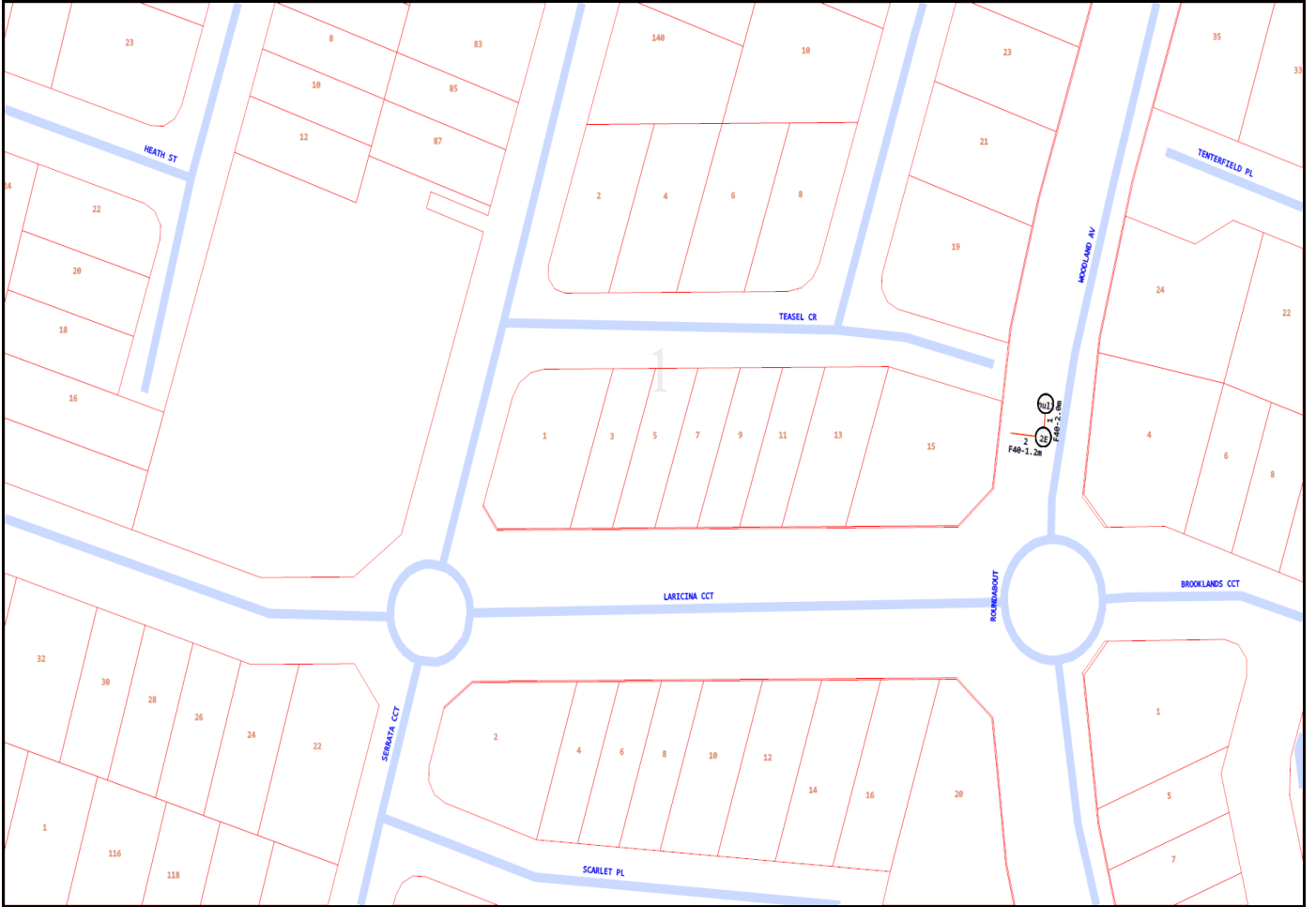

## Emergency Contacts

You must immediately report any damage to the **nbn**™ network that you are/become aware of. Notification may be by telephone - 1800 626 329.



**To:** Abigail Mercado  
**Phone:** Not Supplied  
**Fax:** Not Supplied  
**Email:** property1@ilookproperty.com.au

<b>Before You Dig Australia Job #:</b>	38295369	
<b>Sequence #</b>	248885696	
<b>Issue Date:</b>	17/12/2024	
<b>Location:</b>	5 Teasel Cr , Forest Lake , QLD , 4078	

## Information

The area of interest requested by you contains one or more assets.

<b>nbn™ Assets</b>	<b>Search Results</b>
<b>Communications</b>	Asset identified
<b>Electricity</b>	Asset identified

In this notice **nbn™ Facilities** means *underground fibre optic, telecommunications and/or power facilities, including but not limited to cables, owned and controlled by nbn™*

## Location of nbn™ Underground Assets

We thank you for your enquiry. In relation to your enquiry at the above address:

- **nbn's** records indicate that there **ARE nbn™** Facilities in the vicinity of the location identified above ("Location").
- **nbn** indicative plan/s are attached with this notice ("Indicative Plans").
- The Indicative Plan/s show general depth and alignment information only and are not an exact, scale or accurate depiction of the location, depth and alignment of **nbn™** Facilities shown on the Plan/s.
- In particular, the fact that the Indicative Plans show that a facility is installed in a straight line, or at uniform depth along its length cannot be relied upon as evidence that the facility is, in fact, installed in a straight line or at uniform depth.
- You should read the Indicative Plans in conjunction with this notice and in particular, the notes below.
- You should note that, at the present time, the Indicative Plans are likely to be more accurate in showing location of fibre optics and telecommunications cables than power cables. There may be a variation between the line depicted on the Indicative Plans and the location of any power cables. As such, consistent with the notes below, particular care must be taken by you to make your own enquiries and investigations to precisely locate any power cables and manage the risk arising from such cables accordingly.
- The information contained in the Indicative Plan/s is valid for 28 days from the date of issue set out above. You are expected to make your own inquiries and perform your own investigations (including engaging appropriately qualified plant locators, e.g BYDA Certified Locators, at your cost to locate **nbn™** Facilities during any activities you carry out on site).

We thank you for your enquiry and appreciate your continued use of the Before You Dig Australia Service. For any enquiries related to moving assets or Planning and Design activities, please visit the [nbn Commercial Works](#) website to complete the online application form. If you are planning to excavate and require further information, please email [dbyd@nbnco.com.au](mailto:dbyd@nbnco.com.au) or call 1800 626 329.

#### Notes:

1. You are now aware that there are **nbn™** Facilities in the vicinity of the above property that could be damaged as a result activities carried out (or proposed to be carried out) by you in the vicinity of the Location.
2. You should have regard to section 474.6 and 474.7 of the *Criminal Code Act 1995* (CoA) which deals with the consequences of interfering or tampering with a telecommunications facility. Only persons authorised by **nbn** can interact with **nbn's** network facilities.
3. Any information provided is valid only for **28 days** from the date of issue set out above.

## Referral Conditions

The following are conditions on which **nbn** provides you with the Indicative Plans. By accepting the plans, you are agreeing to these conditions. These conditions are in addition, and not in replacement of, any duties and obligations you have under applicable law.

1. **nbn** does not accept any responsibility for any inaccuracies of its plans including the Indicative Plans. You are expected to make your own inquiries and perform your own investigations (including engaging appropriately qualified plant locators, e.g BYDA Certified Locators, at your cost to locate **nbn™** Facilities during any activities you carry out on site).
2. You acknowledge that **nbn** has specifically notified you above that the Indicative Plans are likely to be more accurate in showing location of fibre optics and telecommunications cables than power cables. There may be a variation between the line depicted on the Indicative Plans and the location of any power cables.
3. You should not assume that **nbn™** Facilities follow straight lines or are installed at uniformed depths

along their lengths, even if they are indicated on plans provided to you. Careful onsite investigations are essential to locate the exact position of cables.

4. In carrying out any works in the vicinity of **nbn**™ Facilities, you must maintain the following minimum clearances:
  - 300mm when laying assets inline, horizontally or vertically.
  - 500mm when operating vibrating equipment, for example: jackhammers or vibrating plates.
  - 1000mm when operating mechanical excavators.
  - Adherence to clearances as directed by other asset owner's instructions and take into account any uncertainty for power cables.
5. You are aware that there are inherent risks and dangers associated with carrying out work in the vicinity of underground facilities (such as **nbn**™ fibre optic, copper and coaxial cables, and power cable feed to **nbn**™ assets). Damage to underground electric cables may result in:
  - Injury from electric shock or severe burns, with the possibility of death.
  - Interruption of the electricity supply to wide areas of the city.
  - Damage to your excavating plant.
  - Responsibility for the cost of repairs.
6. You must take all reasonable precautions to avoid damaging **nbn**™ Facilities. These precautions may include but not limited to the following:
  - All excavation sites should be examined for underground cables by careful hand excavation. Cable cover slabs if present must not be disturbed. Hand excavation needs to be undertaken with extreme care to minimise the likelihood of damage to the cable, for example: the blades of hand equipment should be aligned parallel to the line of the cable rather than digging across the cable.
  - If any undisclosed underground cables are located, notify **nbn** immediately.
  - All personnel must be properly briefed, particularly those associated with the use of earth-moving equipment, trenching, boring and pneumatic equipment.
  - The safety of the public and other workers must be ensured.
  - All excavations must be undertaken in accordance with all relevant legislation and regulations.
7. You will be responsible for all damage to **nbn**™ Facilities that are connected whether directly, or indirectly with work you carry out (or work that is carried out for you or on your behalf) at the Location. This will include, without limitation, all losses expenses incurred by **nbn** as a result of any such damage.
8. You must immediately report any damage to the **nbn**™ network that you are/become aware of. Notification may be by telephone - 1800 626 329.
9. Except to the extent that liability may not be capable of lawful exclusion, **nbn** and its servants and agents and the related bodies corporate of **nbn** and their servants and agents shall be under no liability whatsoever to any person for any loss or damage (including indirect or consequential loss or damage) however caused (including, without limitation, breach of contract negligence and/or breach of statute) which may be suffered or incurred from or in connection with this information sheet or any plans (including Indicative Plans) attached hereto. Except as expressly provided to the contrary in this information sheet or the attached plans (including Indicative Plans), all terms, conditions, warranties, undertakings or representations (whether expressed or implied) are excluded to the fullest extent permitted by law.

All works undertaken shall be in accordance with all relevant legislations, acts and regulations applicable to the particular state or territory of the Location. The following table lists all relevant documents that shall be considered and adhered to.

State/Territory	Documents
<b>National</b>	Work Health and Safety Act 2011
	Work Health and Safety Regulations 2011
	Safe Work Australia - Working in the Vicinity of Overhead and Underground Electric Lines (Draft)

	Occupational Health and Safety Act 1991
<b>NSW</b>	Electricity Supply Act 1995
	Work Cover NSW - Work Near Underground Assets Guide
	Work Cover NSW - Excavation Work: Code of Practice
<b>VIC</b>	Electricity Safety Act 1998
	Electricity Safety (Network Asset) Regulations 1999
<b>QLD</b>	Electrical Safety Act 2002
	Code of Practice for Working Near Exposed Live Parts
<b>SA</b>	Electricity Act 1996
<b>TAS</b>	Tasmanian Electricity Supply Industry Act 1995
<b>WA</b>	Electricity Act 1945
	Electricity Regulations 1947
<b>NT</b>	Electricity Reform Act 2005
	Electricity Reform (Safety and Technical) Regulations 2005
<b>ACT</b>	Electricity Act 1971

Thank You,

**nbn BYDA**

Date: 17/12/2024

This document is provided for information purposes only. This document is subject to the information classification set out on this page. If no information classification has been included, this document must be treated as UNCLASSIFIED, SENSITIVE and must not be disclosed other than with the consent of nbn co. The recipient (including third parties) must make and rely on their own inquiries as to the currency, accuracy and completeness of the information contained herein and must not use this document other than with the consent of nbn co.

Copyright © 2021 nbn co Limited. All rights reserved.



# Working near nbn™ cables

**nbn** has partnered with Dial Before You Dig to give you a single point of contact to get information about **nbn** underground services owned by **nbn** and other utility/service providers in your area including communications, electricity, gas and other services. Contact with underground power cables and gas services can result in serious injury to the worker, and damage and costly repairs. You must familiarise yourself with all of the Referral Conditions (meaning the referral conditions referred to in the DBYD Notice provided by **nbn**).

## Practice safe work habits

Once the DBYD plans are reviewed, the Five P's of Excavation should be adopted in conjunction with your safe work practices (which must be compliant with the relevant state Electrical Safety Act and Safe Work Australia "Excavation Work Code of Practice", as a minimum) to ensure the risk of any contact with underground **nbn** assets are minimised.



**Plan:** Plan your job by ensuring the plans received are current and apply to the work to be performed. Also check for any visual cues that may indicate the presence of services not covered in the DBYD plans.



**Prepare:** Prepare for your job by engaging a DBYD Certified Plant Locator to help interpret plans and identify on-site assets. Contact **nbn** should you require further assistance.



**Pothole:** Non-destructive potholing (i.e. hand digging or hydro excavation) should be used to positively locate **nbn** underground assets with minimal risk of contact and service damage.

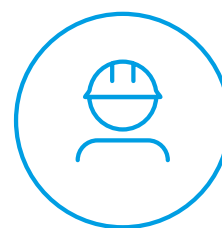

**Protect:** Protecting and supporting the exposed **nbn** underground asset is the responsibility of the worker. Exclusion zones for **nbn** assets are clearly stated in the plan and appropriate controls must be implemented to ensure that encroachment into the exclusion zone by machinery or activities with the potential to damage the asset is prevented.

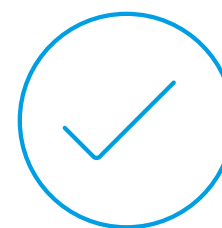

**Proceed:** Proceed only when the appropriate planning, preparation, potholing and protective measures are in place.

# Working near **nbn**<sup>TM</sup> cables

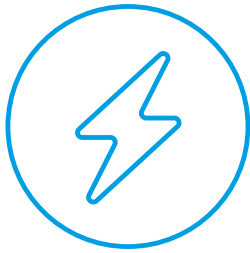

Identify all electrical hazards, assess the risks and establish control measures.

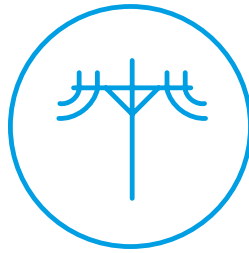

When using excavators and other machinery, also check the location of overhead power lines.

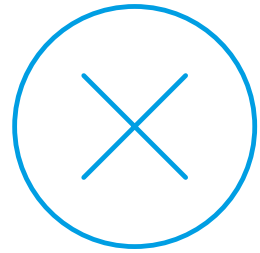

Workers and equipment must maintain safety exclusion zones around power lines.

---

Once all work is completed, the excavation should be re-instated with the same type of excavated material unless specified by **nbn**. Please note:

- Construction Partners of **nbn** may require additional controls to be in place when performing excavation activities.
- The information contained within this pamphlet must be used in conjunction with other material supplied as part of this request for information to adequately control the risk of potential asset damage.

## Contact

All **nbn**<sup>TM</sup> network facility damages must be reported online [here](#).  
For enquiries related to your DBYD request please call 1800 626 329.

### Disclaimer

This brochure is a guide only. It does not address all the matters you need to consider when working near our cables. You must familiarise yourself with other material provided (including the Referral Conditions) and make your own inquiries as appropriate.

**nbn** will not be liable or responsible for any loss, damage or costs incurred as a result of reliance on this brochure.

This document is provided for information purposes only. This document is subject to the information classification set out on this page. If no information classification has been included, this document must be treated as UNCLASSIFIED, SENSITIVE and must not be disclosed other than with the consent of nbn co. The recipient (including third parties) must make and rely on their own inquiries as to the currency, accuracy and completeness of the information contained herein and must not use this document other than with the consent of nbn co. Copyright © 2021 nbn co limited. All rights reserved.



**Referral**  
248885701

**Member Phone**  
13 26 57

## Responses from this member

**Response received** Tue 17 Dec 2024 12.45pm

<b>File name</b>	<b>Page</b>
Response Body	112
Urban Utilities Important Information.pdf	114
248885701 - Urban Utilities Plan.pdf	115



GPO Box 2765  
Brisbane QLD 4001

Date: 17 Dec 2024

## Before You Dig Australia Response

---

**Please DO NOT SEND A REPLY to this email as it has been automatically generated and replies are not monitored.**

Dear Abigail Mercado

We appreciate your diligence in contacting the Before You Dig Australia service (**BYDA**) prior to engaging in work or activities which may affect the water and sewerage infrastructure of Urban Utilities.

<b>Job Number:</b>	38295369
<b>Sequence Number:</b>	248885701
<b>Enquiry Date:</b>	17/12/2024 3:43:00 PM
<b>Enquiry Location:</b>	5 Teasel Cr Forest Lake QLD 4078

**WARNING: When working in the vicinity of Urban Utilities' assets you have a legal *Duty of Care* that must be observed.**

**Our records indicate the presence of infrastructure owned by Urban Utilities within your nominated search area, as shown on the attached plan.**

Please note that you may be liable for any loss or damage to our infrastructure which is caused by any works or activities which you undertake over or near such infrastructure. Additionally, your works or activities may conflict with other works scheduled in your nominated search area. To avoid any unnecessary impacts, before any undertaking you must obtain the following approvals:

- And/or a Urban Utilities Network Access Permit for self assessable works or activities that are within two metres of our infrastructure (refer to [Urban Utilities Network Access Permit Webpage](#))
- Either a Build Over Asset (BOA) Approval for assessable building works undertaken within specified distances of our infrastructure (refer to [DHPW BOA Factsheet](#))

We have provided additional information about your responsibilities in relation to our infrastructure in the Important Information sheet attached to this letter. By accessing BYDA to obtain our records about our infrastructure, you warrant that you have read the sheet and agree to the terms and conditions set out therein.



For further enquiries or assistance with interpretation of plans and search content please contact our BYDA Support Team by email [networkaccess@urbanutilities.com.au](mailto:networkaccess@urbanutilities.com.au). Alternatively, you can write to us at Urban Utilities, PO Box 2765, Brisbane QLD 4001.

Thank you for taking the time to consult the BYDA service.

Yours sincerely

Before You Dig Australia Support Team  
**Urban Utilities**  
[networkaccess@urbanutilities.com.au](mailto:networkaccess@urbanutilities.com.au)

---

To best manage the risk of damage and liability, we recommend that you engage the services of a [BYDA Certified Locator](#)

---

### Important Notice

This enquiry response, including any associated documentation, has been assessed and compiled from the information detailed within the BYDA enquiry outlined above. **Please ensure that the BYDA enquiry details and this response accurately reflect your proposed works.**

This response is intended for use only by the addressee. If you have received the enquiry response in error, please let us know by telephone and delete all copies; you are advised that copying, distributing, disclosing or otherwise acting in reliance on the response is expressly prohibited.

**Disclaimer:** While reasonable measures have been taken to ensure the accuracy of the information contained in this plan response, neither Urban Utilities nor PelicanCorp shall have any liability whatsoever in relation to any loss, damage, cost or expense arising from the use of this plan response or the information contained in it or the completeness or accuracy of such information. Use of such information is subject to and constitutes acceptance of these terms.

If you are unable to launch any of the files for viewing and printing, you may need to download and install free viewing and printing software such as [Adobe Acrobat Reader \(for PDF files\)](#).

## Important Information

### **Disclaimer**

All Urban Utilities' records, data and information supplied via BYDA ("**Data**") is **indicative** only. You agree that any Data supplied to you has been or will be provided only for your convenience and has not been and will not be relied upon by you for any purpose.

You also agree that Urban Utilities does not assume any responsibility or duty of care in respect of, or warrant, guarantee or make any representation as to the Data (including its accuracy, reliability, currency or suitability).

Because the location of Urban Utilities' infrastructure shown on the Data is approximate only, you must first physically locate the infrastructure by utilising relevant site detection methodologies prior to performing any works or undertaking any activities near or adjacent to infrastructure. Possible site detection methodologies include hand digging, potholing, trenching and/or probing. You are solely responsible for the selection of appropriate site detection methodologies at all times.

To the fullest extent permitted by law, Urban Utilities will not be liable to you in contract, tort, equity, under statute or otherwise arising from or in connection with the provision of any Data to you via BYDA.

### **Compliance with laws**

There may be both indicated and unmarked hazards, dangers or encumbrances, including underground asbestos pipes and abandoned mains within your nominated search area. You are solely responsible for ensuring that appropriate care is taken at all times and that you comply with all mandatory requirements relating to such matters, including in relation to workplace health and safety.

### **Damaged Infrastructure**

Please note that it is an offence under Section 192 of the *Water Supply (Safety and Reliability) Act 2008* to interfere with our infrastructure without Urban Utilities' written consent.

You may be liable to Urban Utilities for any loss of or damage to our infrastructure, together with any consequential or indirect loss or damage (including without limitation, loss of use, loss of profits or loss of revenue) arising from or in connection with any interference with Urban Utilities' infrastructure by you or any other person for which you are legally responsible.

Any damage to Urban Utilities' Infrastructure must be reported immediately to the (24 Hours) Faults and Emergencies Team on 13 23 64.

### **Links**

Technical Standards: <https://urbanutilities.com.au/development/help-and-advice/standards-and-guidelines>

### **Copyright**

All Data is copyright.

# Urban Utilities - Water, Recycled Water and Sewer Infrastructure

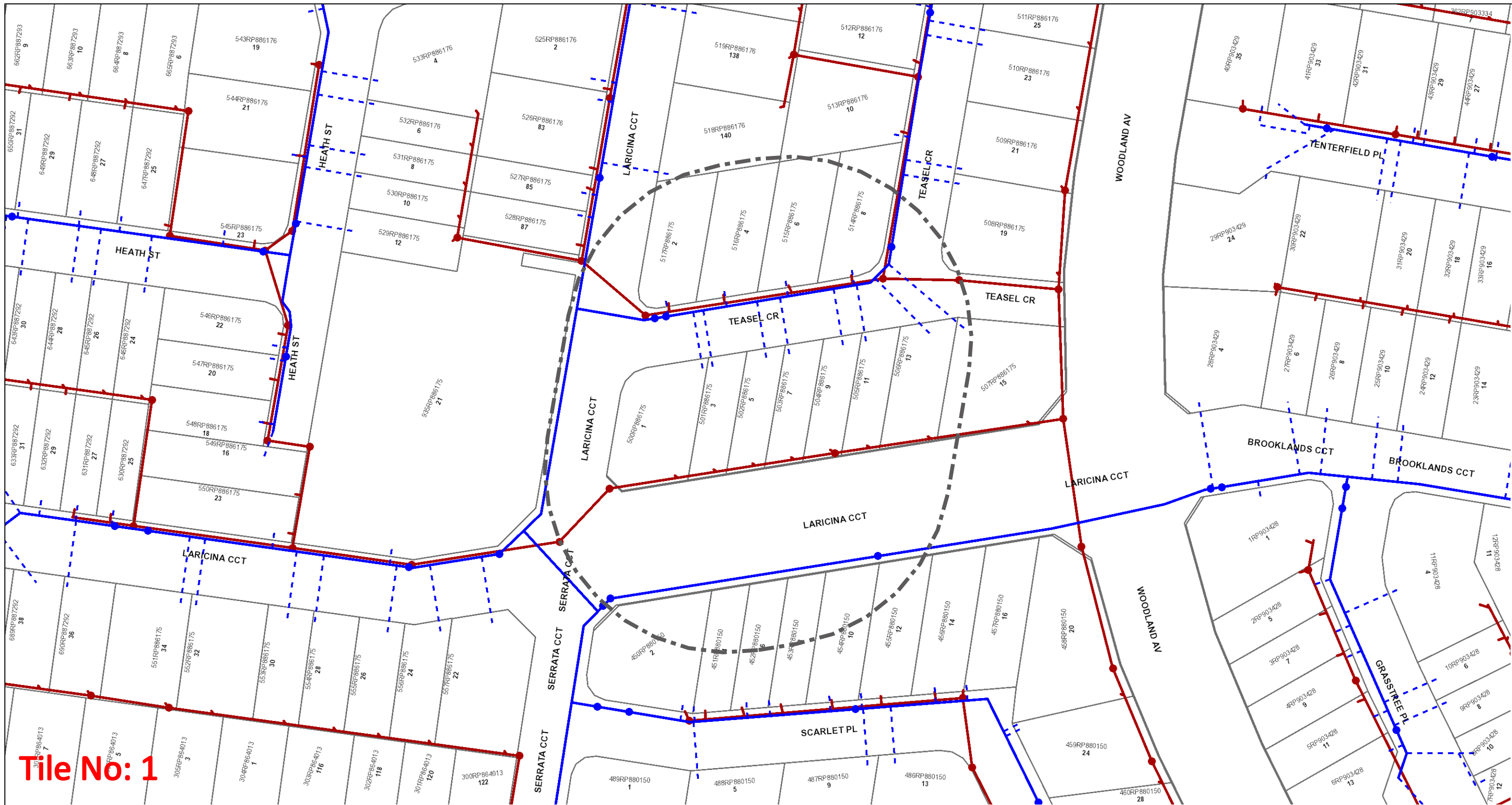

Tile No: 1

 <p><b>UrbanUtilities</b></p> <p>N</p> <p>Map Scale 1:1000</p>	<p><b>Before You Dig Australia- Urban Utilities Water, Recycled Water and Sewer Infrastructure</b></p> <p><b>BYDA Reference No: 248885701</b></p> <p>Date BYDA Ref Received: 17/12/2024 Date BYDA Job to Commence: 08/01/2025 Date BYDA Map Produced: 16/12/2024</p> <p>This Map is valid for 30 days      Produced By: Urban Utilities</p>	<table border="0"> <tr> <th>Sewer</th> <th>Water</th> <th>Recycled Water</th> </tr> <tr> <td>● Infrastructure</td> <td>● Infrastructure</td> <td>● Infrastructure</td> </tr> <tr> <td>◆ Major Infrastructure</td> <td>◆ Major Infrastructure</td> <td>◆ Major Infrastructure</td> </tr> <tr> <td>— Network Pipelines</td> <td>— Network Pipelines</td> <td>— Network Pipelines</td> </tr> <tr> <td>▨ Network Structures</td> <td>▨ Network Structures</td> <td>▨ Network Structures</td> </tr> <tr> <td></td> <td>--- Water Service (Indicative only)</td> <td></td> </tr> </table>	Sewer	Water	Recycled Water	● Infrastructure	● Infrastructure	● Infrastructure	◆ Major Infrastructure	◆ Major Infrastructure	◆ Major Infrastructure	— Network Pipelines	— Network Pipelines	— Network Pipelines	▨ Network Structures	▨ Network Structures	▨ Network Structures		--- Water Service (Indicative only)		<p>While reasonable measures have been taken to ensure the accuracy of the information contained in this plan response, neither Urban Utilities nor PelicanCorp shall have any liability whatsoever in relation to any loss, damage, cost or expense arising from the use of this plan response or the information contained in it or the completeness or accuracy of such information. Use of such information is subject to and constitutes acceptance of these terms.</p> <p>The plans are indicative and approximate only and provided without warranties of any kind, express or implied including in relation to accuracy, completeness, correctness, currency or fitness for purpose.</p> <p>Urban Utilities takes no responsibility and accepts no liability for any loss, damage, costs or liability that may be incurred by any person acting in reliance on the information provided on the plans.</p> <p>This plan should be used as guide only. Any dimensions should be confirmed on site by the relevant authority.</p> <p>Based on or contains data provided by the State of Queensland (Department of Natural Resources and Mines) [2020]. In consideration of the State permitting the use of this data you acknowledge and agree that the State gives no warranty in relation to the data (including accuracy, liability in negligence) for any loss, damage or costs (including consequential damage) relating to any use of the data. Data must not be used for direct marketing or be used in breach of the privacy laws. © State of Queensland Department of Natural Resources and Mines [2020]</p> <p>For further information, please call Urban Utilities on 13 26 57 (8am-6pm weekdays). Faults and emergencies 13 23 64 (24/7). <a href="http://www.urbanutilities.com.au">www.urbanutilities.com.au</a></p> <p>ABN 86 673 835 011</p>
Sewer	Water	Recycled Water																			
● Infrastructure	● Infrastructure	● Infrastructure																			
◆ Major Infrastructure	◆ Major Infrastructure	◆ Major Infrastructure																			
— Network Pipelines	— Network Pipelines	— Network Pipelines																			
▨ Network Structures	▨ Network Structures	▨ Network Structures																			
	--- Water Service (Indicative only)																				

**Referral**  
248885700

**Member Phone**  
1800 653 935

## Responses from this member

**Response received** Tue 17 Dec 2024 8.54pm

File name	Page
Response Body	117
248885700.pdf	119
AccreditedPlantLocators 2024-09-13a.pdf	121
Telstra Map Legend 4.0b.pdf	122
Telstra Duty of Care v32.0b.pdf	123

**Attention:** Abigail Mercado

**Site Location:** 5 Teasel Cr, Forest Lake, QLD 4078

**Your Job Reference:** 5 Teasel Cr

**Please do not reply to this email, this is an automated message -**



Important - this site is within or in the vicinity of a **RED IMPORTED FIRE ANT RESTRICTED AREA**. Movement controls apply. Penalties of up to \$220,000 for individuals and \$1.1 million for corporations may apply. Call **13 25 23** or visit [www.daff.qld.gov.au/fireants](http://www.daff.qld.gov.au/fireants) for further information.

Thank you for requesting Telstra information via Before You Dig Australia (BYDA).

This response contains Telstra information relating to your recent BYDA request.

Information for opening Telstra Asset Plans as well as some other useful contact information is listed in the attached **Telstra Map Legend attached.**

**Please refer to all enclosed attachments for more information.**

**Please Report Damage to Telstra Equipment:** [Report damages to Telstra equipment - Telstra](#)

Please note:

When working in the vicinity of telecommunications plant you have a 'Duty of Care' that must be observed. Please ensure you read the 'Telstra Duty of Care' document (attached) - it contains important information including essential steps that must be undertaken prior to commencing construction activities.

**WARNING - MAJOR CABLES and/or OPTIC FIBRE IN THE AREA.**

**Phone 1800 653 935 for further assistance.**

Note: In some areas Telstra fibre routes may be marked as "Amcom", as Telstra has purchased much of this infrastructure. If in doubt, please contact Telstra Plan services on the number above. Telstra plans and information are only valid for 60 days from the date of issue.

**WARNING:**

Telstra plans and location information conform to Quality Level 'D' of the Australian Standard AS 5488 - Classification of Subsurface Utility Information. As such, Telstra supplied location information is indicative only. Spatial accuracy is not applicable to Quality Level D. Refer to AS 5488 for further details. The exact position of Telstra assets can only be validated by physically exposing them. Telstra does not warrant or hold out that its plans are accurate and accepts no responsibility for any inaccuracy. Further on site investigation is required to validate the exact location of Telstra assets prior to commencing work. A Certified Locating Organisation is an essential part of the process to validate the exact location of Telstra assets and to ensure the assets are protected during construction works. See the [Steps - Working Near Telecommunications Assets \(attached Telstra Duty of Care\)](#).

Please note that:

- it is a criminal offence under the *Criminal Code Act 1995* (Cth) to tamper or interfere with telecommunications infrastructure.
- Telstra will take action to recover compensation for damage caused to property and assets, and for interference with the operation of Telstra's networks and customers' services.

Telstra's plans contain Telstra's confidential information and are provided on the basis that they are used solely for identifying the location or vicinity of Telstra's infrastructure to avoid damage to this infrastructure occurring as part of any digging or other excavation activity. You must not use Telstra's plans for any other purpose or in a way that will cause Telstra loss or damage and you must comply with any other terms of access to the data that have been provided to you by Telstra (including Conditions of Use or Access).

*(See attached file: Telstra Duty of Care v32.0b.pdf)*

*(See attached file: Telstra Map Legend 4.0b.pdf)*

*(See attached file: AccreditedPlantLocators 2024-09-13a.pdf)*

*(See attached file: 248885700.pdf)*

# Cable Plan

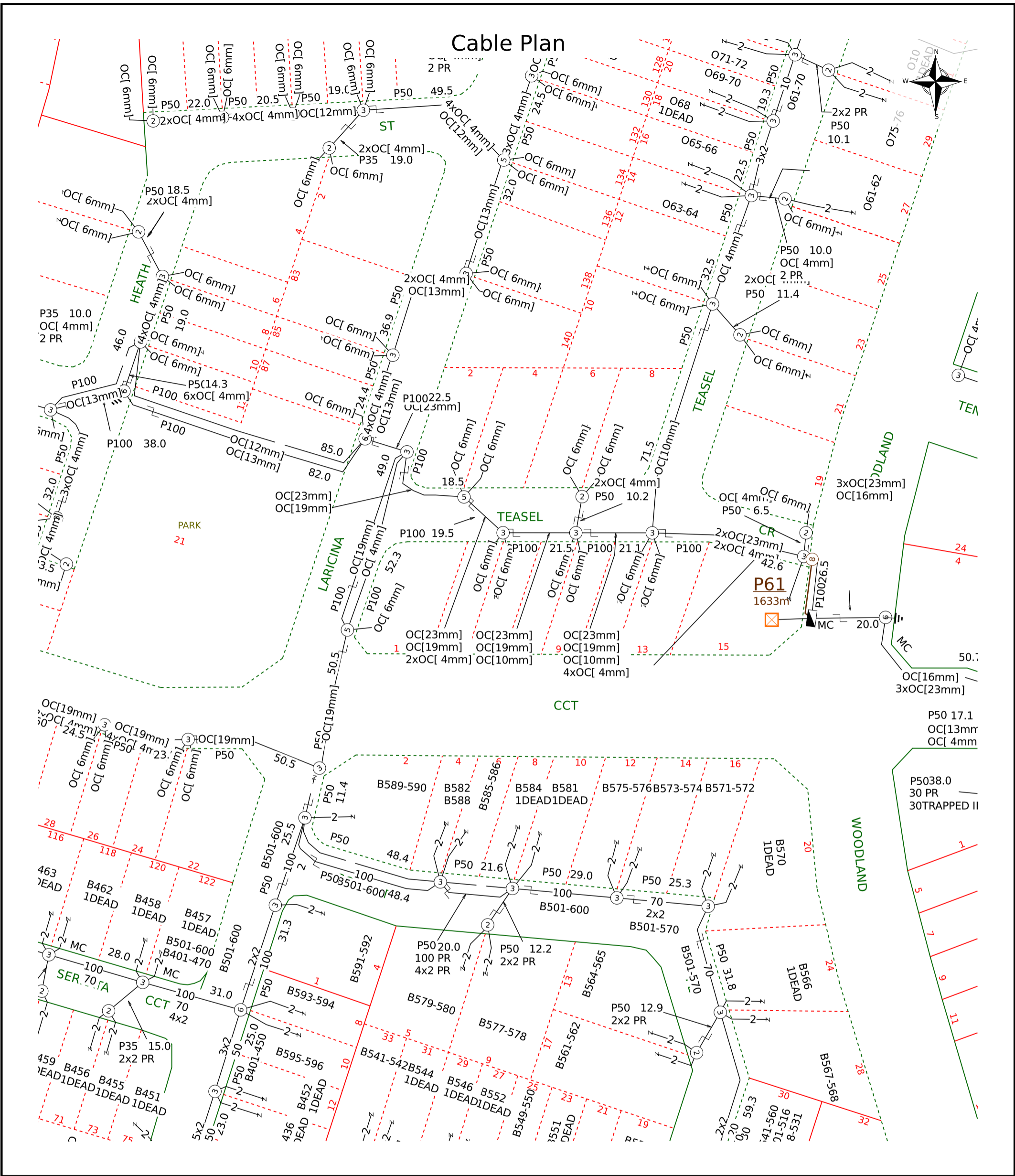

Report Damage <https://service.telstra.com.au/customer/general/forms/report-damage-to-telstra/>  
 Ph - 13 22 03  
 Email - Telstra.Plans@team.telstra.com  
 Planned Services - ph 1800 653 935 (AEST bus hrs only) General Enquiries

Sequence Number: 248885700

**CAUTION: Fibre optic and/ or major network present in plot area. Please read the Duty of Care and contact Telstra Plan Services should you require any assistance.**

TELSTRA LIMITED A.C.N. 086 174 781  
 Generated On 17/12/2024 23:51:17

The above plan must be viewed in conjunction with the Mains Cable Plan on the following page

**WARNING**  
 Telstra plans and location information conform to Quality Level "D" of the Australian Standard AS 5488-Classification of Subsurface Utility Information. As such, Telstra supplied location information is indicative only. Spatial accuracy is not applicable to Quality Level D. Refer to AS 5488 for further details. The exact position of Telstra assets can only be validated by physically exposing it. Telstra does not warrant or hold out that its plans are accurate and accepts no responsibility for any inaccuracy. Further on site investigation is required to validate the exact location of Telstra plant prior to commencing construction work. A Certified Locating Organisation is an essential part of the process to validate the exact location of Telstra assets and to ensure the asset is protected during construction works.

See the Steps- Telstra Duty of Care that was provided in the email response.

# Mains Cable Plan

c14:M1-200 200 CPIUT (AA)  
 c14:M751-800 100 CPFUT (AA)  
 c14:M901-950  
 3008:FA-FB/1-60 60F/- SMOF FNPEHJ/STD (AB)  
 c14:M601-700 100 CPIUT MBHJ (BA)

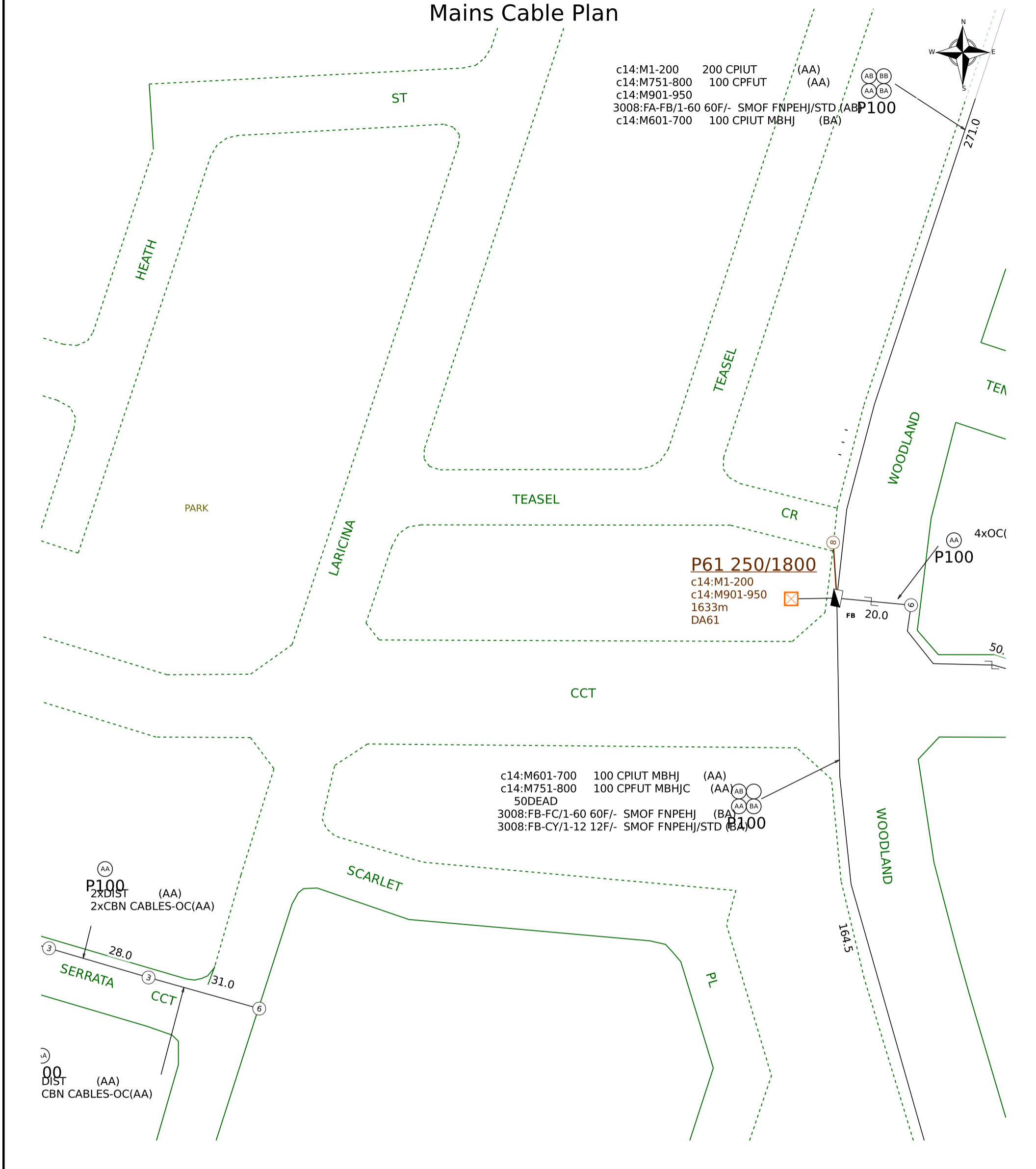
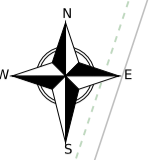

Report Damage <https://service.telstra.com.au/customer/general/forms/report-damage-to-telstra>  
 Ph - 13 22 03  
 Email - Telstra.Plans@team.telstra.com  
 Planned Services - ph 1800 653 935 (AEST bus hrs only) General Enquiries

Sequence Number: 248885700

**CAUTION: Fibre optic and/ or major network present in plot area. Please read the Duty of Care and contact Telstra Plan Services should you require any assistance.**

TELSTRA LIMITED A.C.N. 086 174 781

Generated On 17/12/2024 23:51:19

The above plan must be viewed in conjunction with the Mains Cable Plan on the following page

**WARNING**  
 Telstra plans and location information conform to Quality Level "D" of the Australian Standard AS 5488-Classification of Subsurface Utility Information. As such, Telstra supplied location information is indicative only. Spatial accuracy is not applicable to Quality Level D. Refer to AS 5488 for further details. The exact position of Telstra assets can only be validated by physically exposing it. Telstra does not warrant or hold out that its plans are accurate and accepts no responsibility for any inaccuracy. Further on site investigation is required to validate the exact location of Telstra plant prior to commencing construction work. A Certified Locating Organisation is an essential part of the process to validate the exact location of Telstra assets and to ensure the asset is protected during construction works.

See the Steps- Telstra Duty of Care that was provided in the email response.



## OPENING ELECTRONIC MAP ATTACHMENTS –

Telstra Cable Plans are generated automatically in either PDF or DWF file types.  
Dependent on the site address and the size of area selected.  
You may need to download and install free viewing software from the internet e.g.



DWF Map Files (all sizes over A3)  
Autodesk Viewer (Internet Browser) <https://viewer.autodesk.com/> or  
Autodesk Design Review <http://usa.autodesk.com/design-review/> for  
DWF files. (Windows PC)



PDF Map Files (max size A3)  
Adobe Acrobat Reader <http://get.adobe.com/reader/>



Telstra BYDA map related enquiries email  
[Telstra.Plans@team.telstra.com](mailto:Telstra.Plans@team.telstra.com)  
1800 653 935 (AEST Business Hours only)



REPORT ANY DAMAGE TO THE TELSTRA NETWORK IMMEDIATELY  
Report online - <https://www.telstra.com.au/forms/report-damage-to-telstra-equipment>  
Ph: 13 22 03  
If you receive a message asking for a phone or account number say:  
“I don’t have one” then say “Report Damage” then press 1 to speak  
to an operator.



Telstra New Connections / Disconnections  
13 22 00

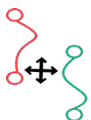

Telstra asset relocation enquiries: 1800 810 443 (AEST business  
hours only).  
[NetworkIntegrity@team.telstra.com](mailto:NetworkIntegrity@team.telstra.com)  
<https://www.telstra.com.au/consumer-advice/digging-construction>



Telstra Aerial Assets Group (overhead network)  
1800 047 909



CERTLOC Certified Locating Organisation (CLO)  
[certloc.com.au/locators/](https://certloc.com.au/locators/)

# LEGEND

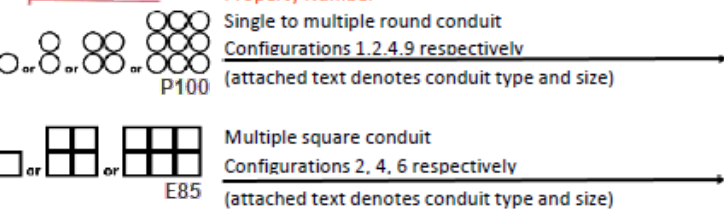
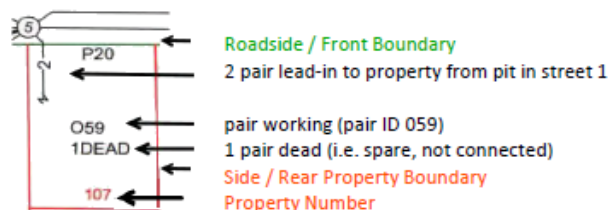
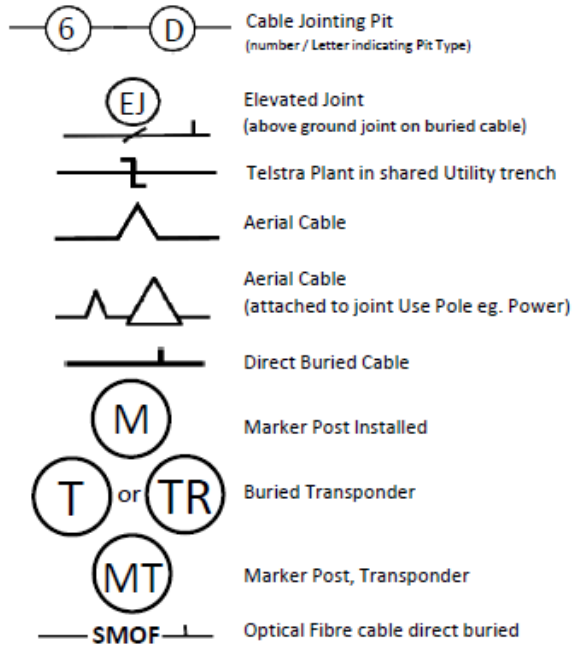
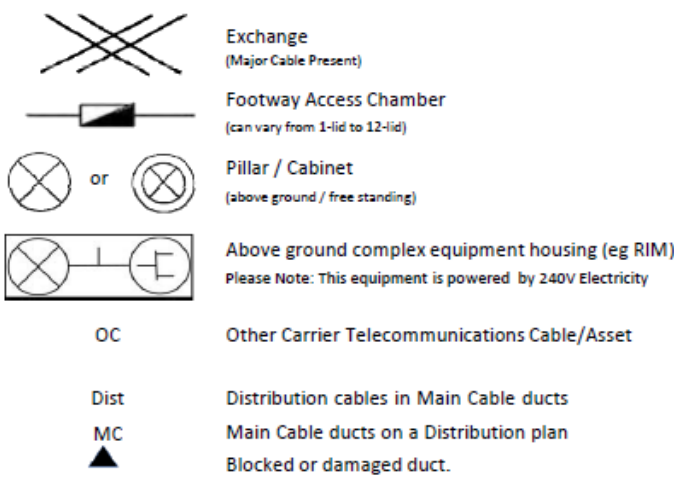

Some examples of conduit type and size:

A - Asbestos cement, P - PVC / Plastic, C - Concrete,  
GI - Galanised iron, E - Earthenware  
Conduit sizes *nominally* range from 20mm to 100mm  
P50 50mm PVC conduit  
P100 100mm PVC conduit  
A100 100mm asbestos cement conduit

## Some Examples of how to read Telstra Plans

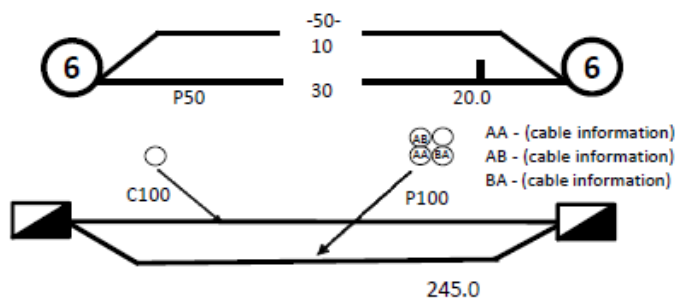

One 50mm PVC conduit (P50) containing a 50-pair and a 10-pair cable between two 6-pits. approximately 20.0m apart, with a direct buried 30-pair cable along the same route

Two separate conduit runs between two footway access chambers (manholes) approximately 245m apart A nest of four 100mm PVC conduits (P100) containing assorted cables in three ducts (one being empty) and one empty 100mm concrete duct (C100) along

## Protect our Network:

by maintaining the following distances from our assets:

- 1.0m Mechanical Excavators, Farm Ploughing, Tree Removal
- 500mm Vibrating Plate or Wacker Packer Compactor
- 600mm Heavy Vehicle Traffic (over 3 tonnes) not to be driven across Telstra ducts or plant.
- 1.0m Jackhammers/Pneumatic Breakers
- 2.0m Boring Equipment (in-line, horizontal and vertical)

For more info contact a [CERTLOC Certified Locating Organisation \(CLO\)](#) or Telstra Location Intelligence Team 1800 653 935

# Before You Dig Australia

## Think before you dig

This document has been sent to you because you requested plans of the Telstra network through Before You Dig Australia (BYDA).

**If you are working or excavating near telecommunications cables, or there is a chance that cables are located near your site, you are responsible to avoid causing damage to the Telstra network.**

Please read this document carefully. Taking your time now and following the steps below can help you avoid damaging our network, interrupting services, and potentially incurring civil and criminal penalties.

Our network is complex and working near it requires expert knowledge. Do not attempt these activities if you are not qualified to do so.

# Disclaimer and legal details



\*Telstra advises that the accuracy of the information provided by Telstra conforms to Quality Level D as defined in AS5488-2013.

It is a criminal offence under the Criminal Code Act 1995 (Cth) to tamper or interfere with telecommunications infrastructure.

Telstra will also take action to recover costs and damages from persons who damage assets or interfere with the operation of Telstra's networks.

By receiving this information including the indicative plans that are provided as part of this information package you confirm that you understand and accept the risks of working near Telstra's network and the importance of taking all the necessary steps to confirm the presence, alignments and various depths of Telstra's network. This in addition to, and not in replacement of, any duties and obligations you have under applicable law.

When working in the vicinity of a telecommunications plant you have a "Duty of Care" that must be observed. Please read and understand all the information and disclaimers provided below.

The Telstra network is complex and requires expert knowledge to interpret information, to identify and locate components, to pothole underground assets for validation and to safely work around assets without causing damage. If you are not an expert and/or qualified in these areas, then you must not attempt these activities. Telstra will seek compensation for damages caused to its property and losses caused to Telstra and its customers. Construction activities and/or any activities that potentially may impact on Telstra's assets must not commence without first undertaking these steps. Construction activities can include anything that involves breaking ground, potentially affecting Telstra assets.

If you are designing a project, it is recommended that you also undertake these steps to validate underground assets prior to committing to your design.

This Notice has been provided as a guide only and may not provide you with all the information that is required for you to determine what assets are on or near your site of interest. You will also need to collate and understand all information received from other Utilities and understand that some Utilities are not a part of the BYDA program and make your own enquiries as appropriate. It is the responsibility of the entities undertaking the works to protect Telstra's network during excavation / construction works.

Telstra owns and retains the copyright in all plans and details provided in conjunction with the applicant's request. The applicant is authorised to use the plans and details only for the purpose indicated in the applicant's request. The applicant must not use the plans or details for any other purpose.

Telstra plans or other details are provided only for the use of the applicant, its servants, agents, or CERTLOC Certified Locating Organisation (CLO). The applicant must not give the plans or details to any parties other than these and must not generate profit from commercialising the plans or details.

Telstra, its servants or agents shall not be liable for any loss or damage caused or occasioned by the use of plans and or details so supplied to the applicant, its servants and agents, and the applicant agrees to indemnify Telstra against any claim or demand for any such loss or damage.

Please ensure Telstra plans and information provided always remains on-site throughout the inspection, location, and construction phase of any works.

Telstra plans are valid for 60 days after issue and must be replaced if required after the 60 days.

## Data Extraction Fees

In some instances, a data extraction fee may be applicable for the supply of Telstra information. Typically, a data extraction fee may apply to large projects, planning and design requests or requests to be supplied in non-standard formats. For further details contact Telstra Planned Services.

Telstra does not accept any liability or responsibility for the performance of or advice given by a CERTLOC Certified Locating Organisation (CLO). Certification is an initiative taken by Telstra towards the establishment and maintenance of competency standards. However, performance and the advice given will always depend on the nature of the individual engagement.

Neither the Certified Locating Organisation nor any of its employees are an employee or agent for Telstra. Telstra is not liable for any damage or loss caused by the Certified Locating Organisation or its employees.

Once all work is completed, the excavation should be reinstated with the same type of excavated material unless specified by Telstra.

The information contained within this pamphlet must be used in conjunction with other material supplied as part of this request for information to adequately control the risk of potential asset damage.

When using excavators and other machinery, also check the location of overhead power lines.

Workers and equipment must maintain safety exclusion zones around power lines

**WARNING:** Telstra plans and location information conform to Quality Level 'D' of the Australian Standard AS 5488 - Classification of Subsurface Utility Information. As such, Telstra supplied location information is indicative only. Spatial accuracy is not applicable to Quality Level D. Refer to AS 5488 for further details. Telstra does not warrant or hold out that its plans are accurate and accepts no responsibility for any inaccuracy shown on the plans. **FURTHER ON SITE INVESTIGATION IS REQUIRED TO VALIDATE THE EXACT LOCATION OF TELSTRA PLANT PRIOR TO COMMENCING CONSTRUCTION WORK.** A plant location service is an essential part of the process to validate the exact location of Telstra assets and to ensure the assets are protected during construction works. The exact position of Telstra assets can only be validated by physically exposing them. Telstra will seek compensation for damages caused to its property and losses caused to Telstra and its customers.

## Privacy Note

Your information has been provided to Telstra by BYDA to enable Telstra to respond to your BYDA request. Telstra keeps your information in accordance with its privacy statement. You can obtain a copy at [www.telstra.com.au/privacy](http://www.telstra.com.au/privacy) or by calling us at 1800 039 059 (business hours only).



## End of document

**i** This document may exclude some files (eg. DWF or ZIP files)

This document was automatically generated at a point-in-time. Be aware that the source information from which this document was created may have changed since it was produced. This document may contain incomplete or out-of-date information. Always check your enquiry details in the BYDA Referral Service for the most recent information. For copyright information refer to individual responses.