

WESTERN



AUSTRALIA

TITLE NUMBER

Volume Folio

1829 546

RECORD OF CERTIFICATE OF TITLE
UNDER THE TRANSFER OF LAND ACT 1893 AND THE
STRATA TITLES ACT OF 1985

The person described in the first schedule is the registered proprietor of an estate in fee simple in the land described below subject to the reservations, conditions and depth limit contained in the original grant (if a grant issued) and to the limitations, interests, encumbrances and notifications shown in the second schedule.

BG Roberts
REGISTRAR OF TITLES



LAND DESCRIPTION:

LOT 46 ON STRATA PLAN 17133
TOGETHER WITH A SHARE IN COMMON PROPERTY (IF ANY) AS SET OUT ON THE STRATA PLAN

REGISTERED PROPRIETOR:
(FIRST SCHEDULE)

[REDACTED]
BOTH OF UNIT 46 FLOOR 1 98 MANDURAH TERRACE MANDURAH WA 6210
AS JOINT TENANTS

(T O196318) REGISTERED 18/7/2019

LIMITATIONS, INTERESTS, ENCUMBRANCES AND NOTIFICATIONS:
(SECOND SCHEDULE)

1. INTERESTS NOTIFIED ON THE STRATA PLAN AND ANY AMENDMENTS TO LOTS OR COMMON PROPERTY NOTIFIED THEREON BY VIRTUE OF THE PROVISIONS OF THE STRATA TITLES ACT OF 1985 AS AMENDED.
2. Q229254 MORTGAGE TO HSBC BANK AUSTRALIA LTD REGISTERED 28/11/2024.

Warning: A current search of the sketch of the land should be obtained where detail of position, dimensions or area of the lot is required.

-----END OF CERTIFICATE OF TITLE-----

STATEMENTS:

The statements set out below are not intended to be nor should they be relied on as substitutes for inspection of the land and the relevant documents or for local government, legal, surveying or other professional advice.

SKETCH OF LAND: SP17133
PREVIOUS TITLE: SP17133
PROPERTY STREET ADDRESS: UNIT 46, FLOOR 1 98 MANDURAH TCE, MANDURAH.
LOCAL GOVERNMENT AUTHORITY: CITY OF MANDURAH

PORTION COCKBURN SOUND LOCATION 16 BEING
 PLAN OF LOT 100 ON DIAGRAM 75026
 CERTIFICATE OF TITLE VOL. 1822 FOL 462
 LOCAL AUTHORITY TOWN OF MANDURAH
 LOCALITY MANDURAH INDEX PLAN PEEL 2000.05.01
 NAME OF BUILDING ~~BRADY'S RESORT MOTEL~~ SEE ANNEXURE 'B'
 E 792960
 NAME OF BODY CORPORATE
 (IF STRATA PLAN OF SUBDIVISION
 OR CONSOLIDATION)
 ADDRESS FOR SERVING OF ~~G/ 15 ALTONA ST. WEST PERTH 6005~~
 NOTICES ON COMPANY SEE ANNEXURE B
 PURPOSE

LODGED 15.2.89 6430
 EXAMINED 17.2.89 RWB.
 REGISTERED 17.2.89 App E022995



[Signature]
 REGISTRAR OF TITLES

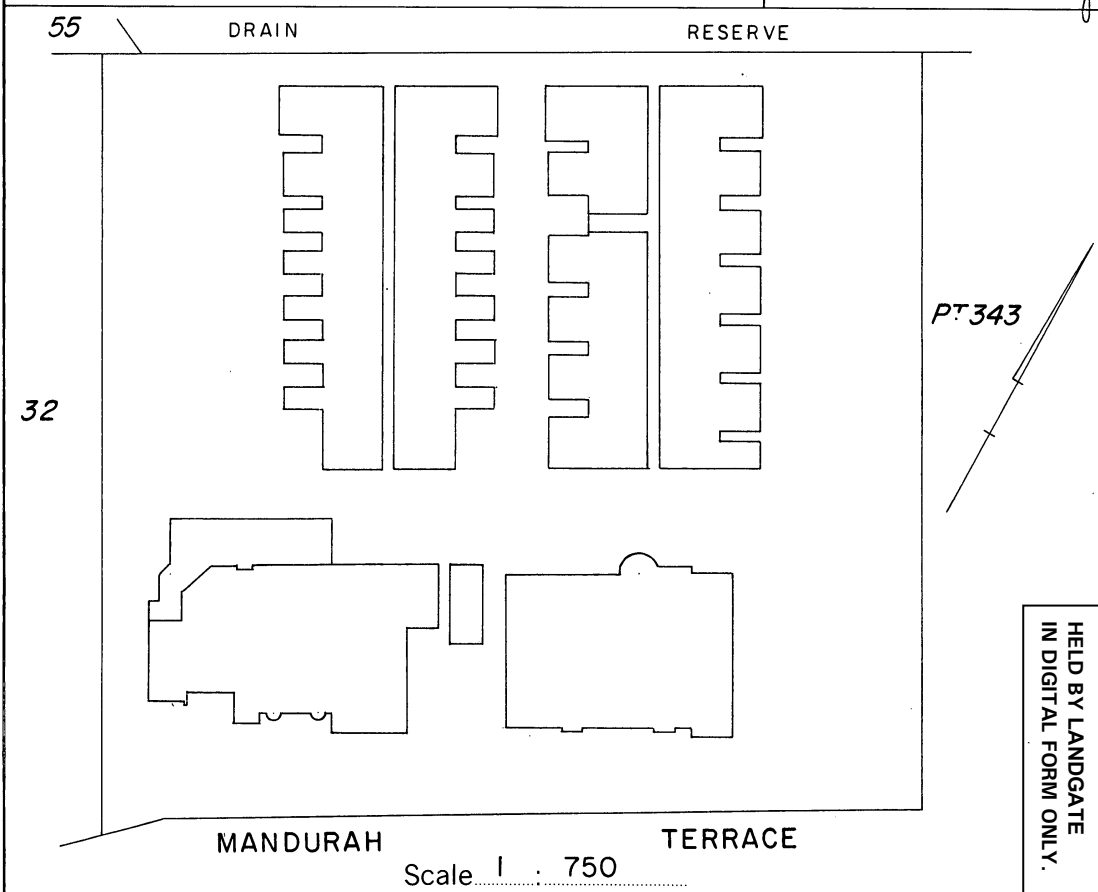

HELD BY LANDGATE
 IN DIGITAL FORM ONLY.

Scale 1 : 750

SCHEDULE OF UNIT ENTITLEMENT		OFFICE USE ONLY	
LOT No.	UNIT ENTITLEMENT	CURRENT Cs. of TITLE	
		VOL.	FOL.
1	6	1829-501, 1967-398	
2	7	1829-502, 1950-497	
3	7	1829-503	
4	5	1829-504, 1973-631	
5	7	1829-505	
6	5	1829-506	
7	5	1829-507	
8	5	1829-508	
9	5	1829-509, 1938-564	
10	5	1829-510	
AGGREGATE	CONTINUES ON ANNEXURE 'A'		

CERTIFICATE OF LICENSED VALUER

I, KEVIN LEONARD EATON being a Licensed Valuer licensed under the Land Valuers Licensing Act 1978 do hereby certify that the unit entitlement of each Lot, as stated in the schedule bears in relation to the aggregate unit entitlement of all Lots delineated on the strata plan a proportion not greater than 5 per cent more or 5 per cent less than the proportion that the capital value of that Lot bears to the aggregate capital value of all the Lots delineated on the plan.

9/12/1988
 Date *[Signature]*
 Signed

43962/11/85-1M-S/7652

ANNEXURE A OF STRATA PLAN No.17133

SCHEDULE OF UNIT ENTITLEMENT		OFFICE USE ONLY CURRENT Cs. of TITLE		SCHEDULE OF UNIT ENTITLEMENT		OFFICE USE ONLY CURRENT Cs. of TITLE	
LOT No.	UNIT ENTITLEMENT	VOL.	FOL.	LOT No.	UNIT ENTITLEMENT	VOL.	FOL.
11	5	1829-511		45	5	1829-545	
12	5	1829-512, 1993-77		46	6	1829-546	
13	5	1829-513		47	6	1829-547	
14	5	1829-514		48	6	1829-548	
15	5	1829-515, 1943-940		49	6	1829-549	
16	7	1829-516		50	6	1829-550	
17	5	1829-517		51	7	1829-551	
18	7	1829-518		52	7	1829-552	
19	7	1829-519, 1950-496		53	6	1829-553	
20	6	1829-520		54	6	1829-554	
21	6	1829-521		55	6	1829-555	
22	5	1829-522		56	6	1829-556	
23	5	1829-523		57	6	1829-557	
24	5	1829-524		58	6	1829-558	
25	5	1829-525, 1981-19		59	109	1829-559, 1942-763	
26	5	1829-526		60	21	1829-560, 1942-762	
27	5	1829-527		61	46	1829-561, 1942-748	
28	5	1829-528, 1992-287		62	12	1829-562, 1950-814.	
29	5	1829-529, 1979-537					
30	5	1829-530					
31	5	1829-531					
32	6	1829-532					
33	6	1829-533					
34	5	1829-534, 1970-983		AGGREGATE	510		
35	5	1829-535, 1996-996		<p>CERTIFICATE OF LICENSED VALUER</p> <p>I, <u>KEVIN LEONARD EATON</u>, being a Licensed Valuer licensed under the Land Valuers Licensing Act 1978 do hereby certify that the unit entitlement of each Lot, as stated in the schedule bears in relation to the aggregate unit entitlement of all Lots delineated on the strata plan a proportion not greater than 5 per cent more or 5 per cent less than the proportion that the capital value of that Lot bears to the aggregate capital value of all the Lots delineated on the plan.</p> <p style="text-align: right;">  Signed </p> <p style="text-align: center;"> <u>9/12/1988</u> Date </p>			
36	5	1829-536, 2023-988					
37	5	1829-537					
38	5	1829-538					
39	5	1829-539					
40	5	1829-540					
41	5	1829-541					
42	5	1829-542					
43	5	1829-543					
44	5	1829-544					

41442-6/85-500-S-7653

STRATA PLAN No.
17133

DESCRIPTION OF PARCEL AND BUILDING

THE BUILDINGS CONSIST OF 59 RESIDENTIAL APARTMENTS, A RECEPTION AREA, RESTAURANT AND FUNCTION CENTRE, CONSTRUCTED FROM CONCRETE FLOORS, BRICK, STEEL AND GYPROCK WALLS, WITH TILE AND IRON ROOFS. THE LAND IS PORTION OF COCKBURN SOUND LOCATION 16 BEING LOT 100 ON DIAGRAM 75026 COMPRISED IN CERTIFICATE OF TITLE VOLUME FOLIO AND KNOWN AS BRADY'S RESORT MOTEL, SITUATED AT 98 MANDURAH TERRACE, MANDURAH.

CERTIFICATE OF SURVEYOR

I, JOHN ZUIDEVELD, being a licensed surveyor registered under the Licensed Surveyors Act 1909, as amended, hereby certify that:—

- (a) each lot that is not wholly within a building shown on the plan is within the external surface boundaries of the parcel; and either
- (b) each building referred to above is within the external surface boundaries of the parcel; or
- ~~(c) in a case where a part of a wall or building, or material attached thereto, encroaches beyond the external surface boundaries of the parcel—~~
- (i) all lots shown on the plan are within the external surface boundaries of the parcel;
- (ii) the plan clearly indicates the existence of the encroachment and its nature and extent; and
- ~~(iii) where the encroachment is not on to a public road, street or way, that an appropriate easement has been granted and registered as an appurtenance of the parcel.~~

7.12.88

Date

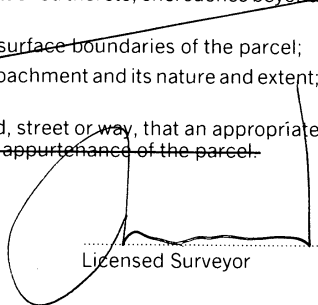

Licensed Surveyor

CERTIFICATE OF LOCAL AUTHORITY

TOWN OF MANDURAH, the local authority hereby certifies that—

- (1) (a) the building and the parcel referred to above has been inspected and that it is consistent with the building plans and specifications in respect of the building thereof that have been approved by the local authority; or
- ~~(b) the building has been inspected and the modification is consistent with the approved building plans and specifications relating to the modification;~~
- (2) the building, in the opinion of the local authority, is of sufficient standard and suitable to be divided into lots pursuant to the Strata Titles Act 1985;
- ~~(3) where a part of a wall or building or material attached thereto encroaches beyond the external surface boundaries of the parcel on to a public road, street or way the Local authority is of the opinion that retention of the encroachment in its existing state will not endanger public safety or unreasonably interfere with the amenity of the neighbourhood and the local authority does not object to the encroachment;~~
- (4) * (a) any conditions imposed by the State Planning Commission have been complied with;
- ~~*(b) the within strata scheme is exempt from the requirement of approval by the State Planning Commission.~~

25/1/1989

Date



Town/Shire Clerk

*Delete whichever is inapplicable

STRATA PLAN No. 17133

STRATA TITLES ACT 1985

**STATE PLANNING COMMISSION
CERTIFICATE OF APPROVAL BY ~~TOWN PLANNING BOARD~~
TO A STRATA PLAN**

STATE PLANNING COMMISSION
It is hereby certified that the approval of the ~~Town Planning Board~~ has been granted pursuant to the provisions of abovementioned Act to:

* (i) the Strata Plan submitted on 26th January 1989
..... and relating to the property described below;

(ii) ~~to the sketch submitted on~~
~~of the proposed subdivision of the property described below into lots on a Strata Plan subject to the following conditions:~~

Property Description: Whole/~~Part~~ Lot(s) 100
Location(s) COCKBURN SOUND LOC 16
Town MANDURAH
Local Authority District TOWN OF MANDURAH
Property Owner PELUS PTY LTD

[Signature]
: For Chairman,
TOWN PLANNING BOARD
STATE PLANNING COMMISSION

Date **14 FEB 1989**
(*To be deleted as appropriate)

STRATA PLAN No. 17133

LOWER GROUND FLOOR

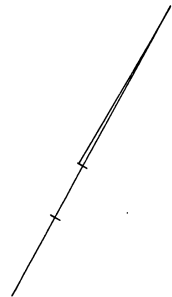

See Sheet 1B for continuation of LOWER GROUND FLOOR.

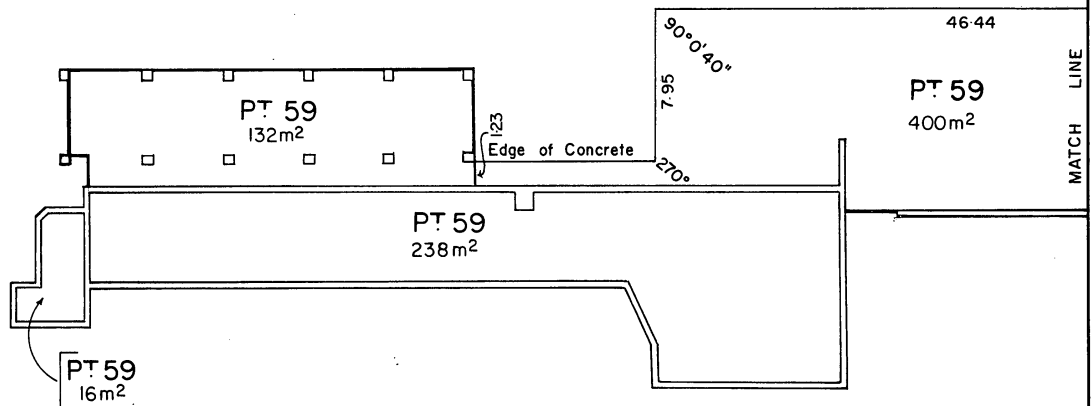

EXCEPT WHERE COVERED THE STRATUM OF THE EXTERNAL PART LOTS EXTENDS FROM 5 METRES BELOW TO 3 METRES ABOVE THE FLOOR LEVEL OF THE ADJACENT PART LOT 59.

Scale 1 : 300

41445/6/85-1M-S/7658

STRATA PLAN No. 17133

GROUND FLOOR

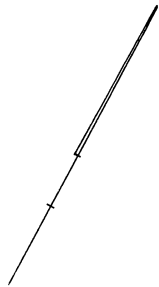

- EXCEPT WHERE COVERED THE STRATUM OF THE EXTERNAL PART LOTS EXTENDS AS FOLLOWS;
1. PART LOT 59 (192m²) TO 3 METRES ABOVE ITS CONCRETE FLOOR.
 2. PART LOT 59 (58 m²) FROM 2 METRES BELOW TO 3 METRES ABOVE THE FLOOR LEVEL OF THE ADJACENT PART LOT 59.
 3. PART LOT 60 (38 m²) FROM 2 METRES BELOW TO 3 METRES ABOVE THE FLOOR LEVEL OF THE ADJACENT PART LOT 60.

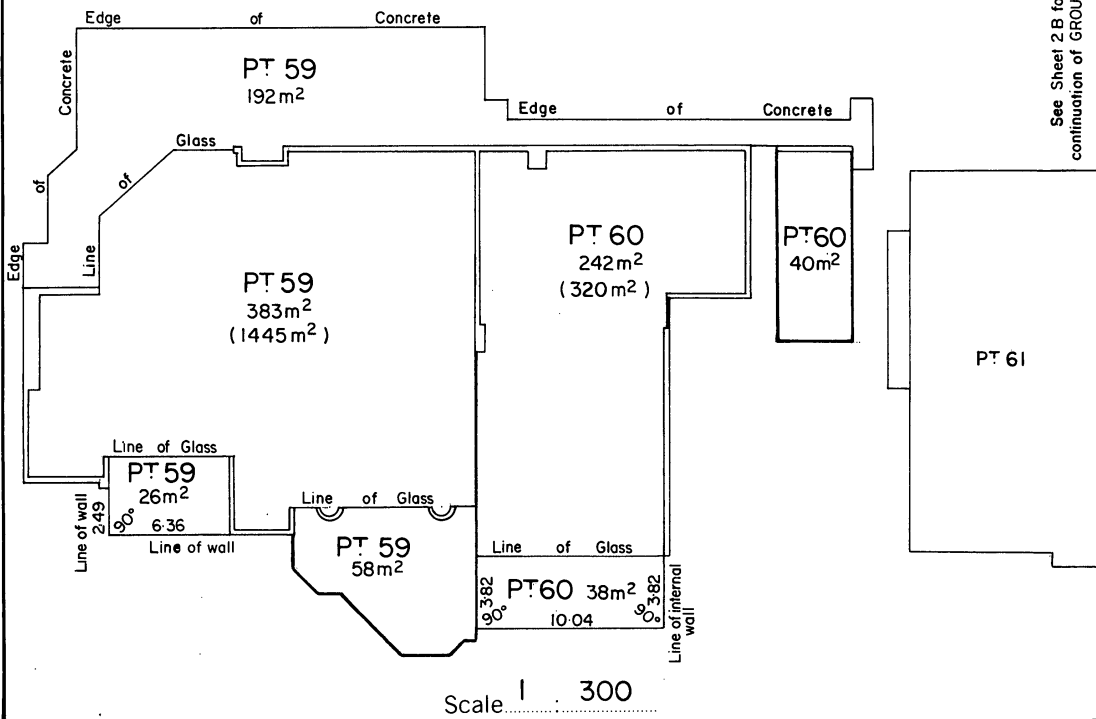
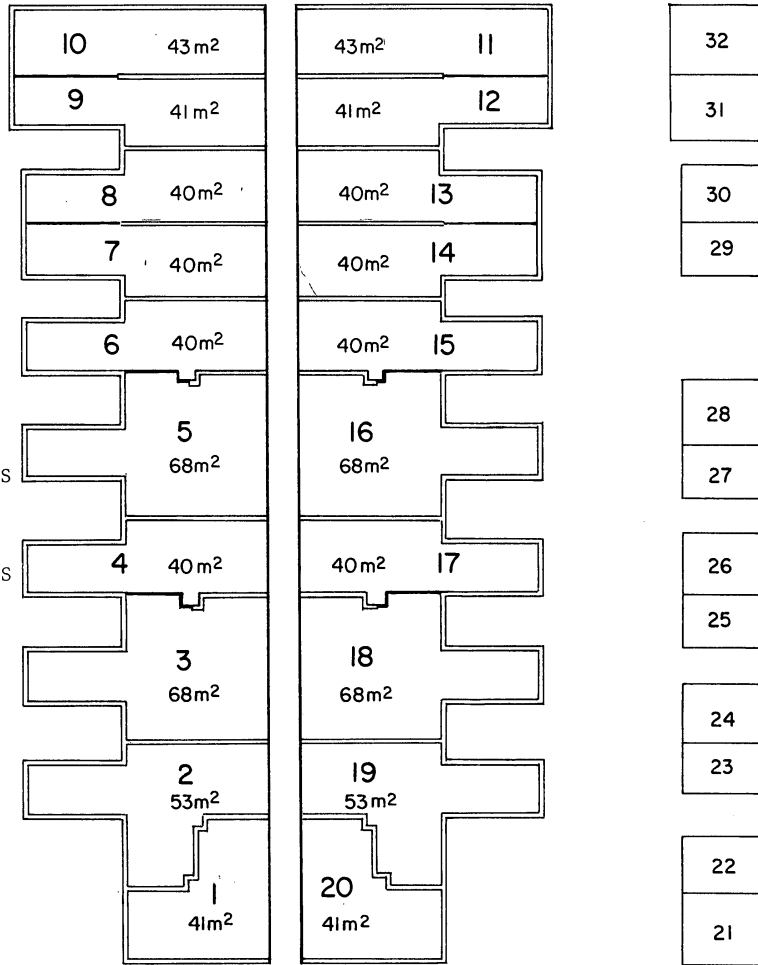

See Sheet 2B for continuation of GROUND FLOOR

41445/6/85-1M-S/7658

STRATA PLAN No. **17133**

LOWER GROUND FLOOR

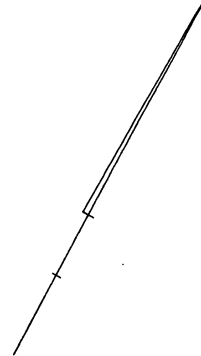

See Sheet 1A for continuation
of LOWER GROUND FLOOR.

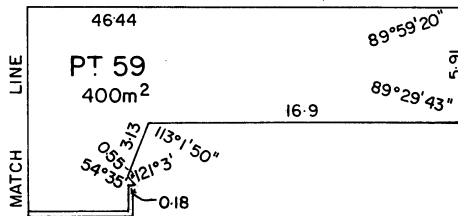

EXCEPT WHERE COVERED THE STRATUM OF THE EXTERNAL PART LOT
EXTENDS FROM 5 METRES BELOW TO 3 METRES ABOVE THE FLOOR
LEVEL OF THE ADJACENT PART LOT 59 AS SHOWN ON SHEET 1A OF 3.

Scale **1 : 300**

41445/6/85-1M-S/7658

STRATA PLAN No. 17133

GROUND FLOOR

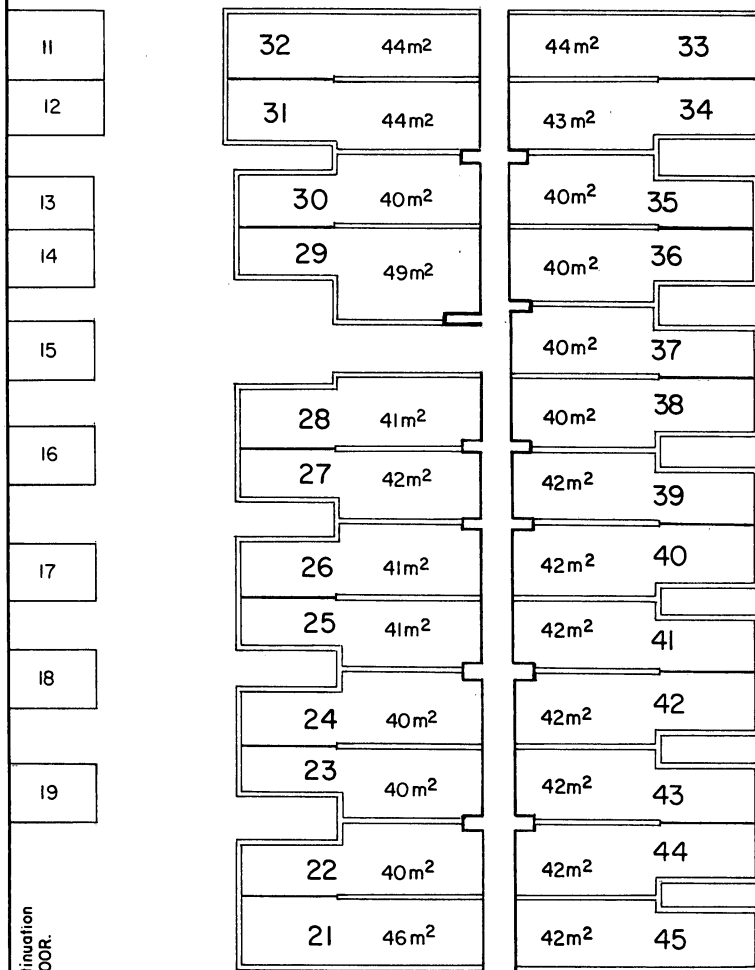

EXCEPT WHERE COVERED THE STRATUM OF THE EXTERNAL PART LOTS EXTENDS AS FOLLOWS;

- PART LOT 61 (91m²) FROM 2 METRES BELOW TO 3 METRES ABOVE THE FLOOR LEVEL OF THE ADJACENT PART LOT 61.
- PART LOT 62 (9m²) FROM 1 METRE BELOW THE FLOOR LEVEL OF THE ADJACENT PART LOT 61 TO 3 METRES ABOVE THE FLOOR LEVEL OF THE ADJACENT PART LOT 62 AS SHOWN ON SHEET 3 OF 3

See Sheet 2A for continuation of GROUND FLOOR.

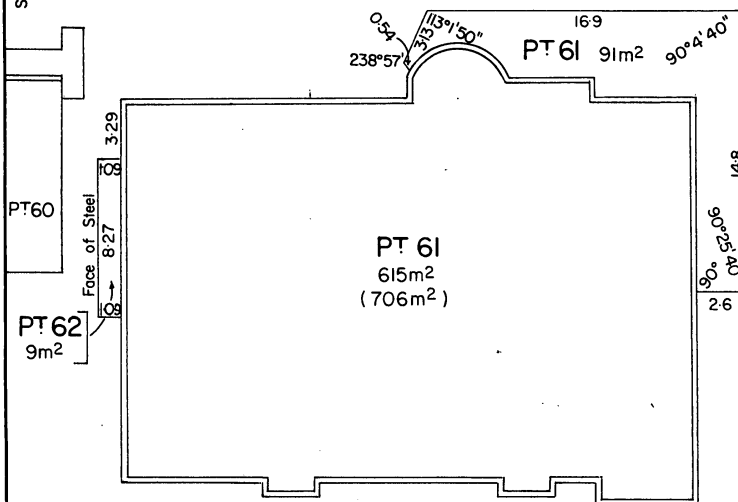

Scale 1 : 300

41445/6/85-1M-S/7658

STRATA PLAN No. 17133

FIRST FLOOR

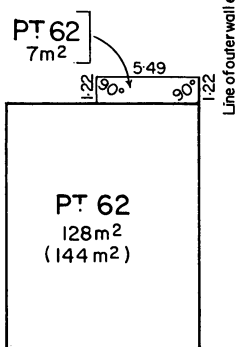
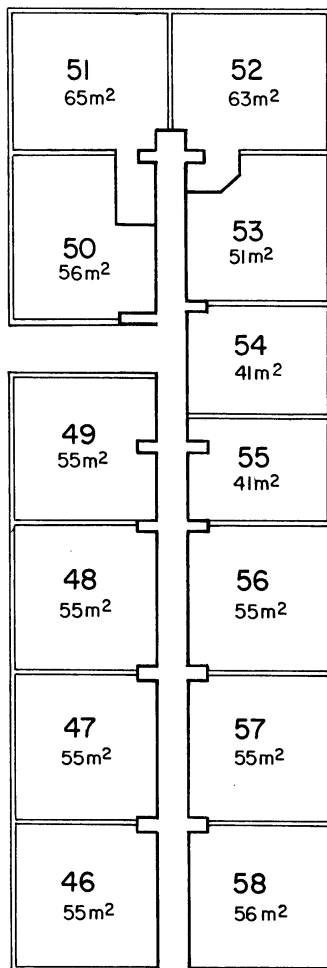

EXCEPT WHERE COVERED THE EXTERNAL PART LOT 62 (7m²) EXTENDS TO 2.5 METRES ABOVE THE FLOOR LEVEL OF THE ADJACENT PART LOT 62.

Scale 1 : 300

41445/6/85-1M-S/7658

REGISTRAR OF TITLES

ANNEXURE B OF STRATA PLAN No. 17133

SCHEDULE OF REGISTERED PROPRIETORS

REGISTERED PROPRIETOR

The name of the Building is now 98 Mandurah Terrace, Mandurah
 The address for serving of notices on the Strata Company is 3/132 Flinders Street, Yokine, WA 6060.
 The address for serving of notices on the Strata Company is Post Office Box 1386, Bunbury, WA 6231.
 The name of the Building is now Mandurah Terrace Apartments.
 The address for serving of notices on the Strata Company is: PO Box 1058 Canning Bridge WA 6153
 The address for serving of notices on the Strata Company is now PO Box 982 Mandurah WA 6210.

NATURE	INSTRUMENT NUMBER	REGIST'D	SIGNATURE OF REGISTRAR OF TITLES
Notification	F792960	23.1.92	<i>[Signature]</i>
Change of address.	F543497	9.5.94	<i>[Signature]</i>
Change of address.	F729753	15.11.94	<i>[Signature]</i>
Application	G91789	2.2.96	<i>[Signature]</i>
Application	G789059	11.5.98	<i>[Signature]</i>
Notification	N824864	6.2.2018	<i>[Signature]</i>

SCHEDULE OF ENCUMBRANCES, ETC.

INSTRUMENT NATURE	INSTRUMENT NUMBER	PARTICULARS	REGIST'D	SIGNATURE OF REGISTRAR OF TITLES	CANCELLATION
Notification	F106181	Notification of change of by-laws	9.2.93	<i>[Signature]</i>	
Notification	F937504	Notification of change of by-laws	22.8.95	<i>[Signature]</i>	
Notification	G91790	Notification of change of by-laws	2.2.96	<i>[Signature]</i>	
NOTIFICATION	G403460	NOTIFICATION OF CHANGE OF BY-LAWS	21.2.97	<i>[Signature]</i>	
Notification	G703970	Notification of change of by-laws.	4.2.98	<i>[Signature]</i>	
Notification	J198660	Notification of change of by-laws.	24.2.05	<i>[Signature]</i>	
Notification	K827821	Notification of change of by-laws	16.1.09	<i>[Signature]</i>	
Notification	M296231	Notification of change of by-laws	6.6.2013	<i>[Signature]</i>	
NOTIFICATION	O081089	NOTIFICATION OF CHANGE OF BY-LAWS	30.1.2019	<i>[Signature]</i>	

NOTE: ENTRIES RULED THROUGH AND AUTHENTICATED BY THE SIGNATURE OF THE REGISTRAR OF TITLES ARE CANCELLED

41446/65-1M-57659

Strata Plan 17133

Lot	Certificate of Title	Lot Status	Part Lot
1	1967/398	Registered	
2	1950/497	Registered	
3	1829/503	Registered	
4	1973/631	Registered	
5	1829/505	Registered	
6	1829/506	Registered	
7	1829/507	Registered	
8	1829/508	Registered	
9	1938/564	Registered	
10	1829/510	Registered	
11	1829/511	Registered	
12	2032/629	Registered	
13	1829/513	Registered	
14	1829/514	Registered	
15	1943/940	Registered	
16	1829/516	Registered	
17	1829/517	Registered	
18	1829/518	Registered	
19	1950/496	Registered	
20	1829/520	Registered	
21	1829/521	Registered	
22	2185/58	Registered	
23	1829/523	Registered	
24	1829/524	Registered	
25	1981/19	Registered	
26	1829/526	Registered	
27	1829/527	Registered	
28	1992/287	Registered	
29	1979/537	Registered	
30	1829/530	Registered	
31	1829/531	Registered	
32	1829/532	Registered	
33	1829/533	Registered	
34	1970/983	Registered	
35	1996/996	Registered	
36	2023/988	Registered	
37	1829/537	Registered	
38	1829/538	Registered	
39	1829/539	Registered	
40	1829/540	Registered	
41	1829/541	Registered	
42	1829/542	Registered	
43	1829/543	Registered	
44	1829/544	Registered	
45	1829/545	Registered	

Strata Plan 17133

Lot	Certificate of Title	Lot Status	Part Lot
46	1829/546	Registered	
47	1829/547	Registered	
48	1829/548	Registered	
49	1829/549	Registered	
50	1829/550	Registered	
51	1829/551	Registered	
52	1829/552	Registered	
53	2038/685	Registered	
54	1829/554	Registered	
55	1829/555	Registered	
56	1829/556	Registered	
57	1829/557	Registered	
58	1829/558	Registered	
59	1942/763	Registered	
60	1942/762	Registered	
61	1942/748	Registered	
62	1950/814	Registered	

No.

87

AE

FEES (office use)	\$	¢
E 792960 AE		
		
REG. \$ 60.00		

Parties

'92 JAN 23 -9 '26

Lodged by

ROD POTTER

Address

31 HOLMESDALE RD.

Phone No.

WEST MIDLAND
2744780

Use this space for instructions if any documents are to issue to other than lodging party.

Titles, Crown Leases, Declarations, etc., lodged with this document. (To be filled in by person lodging.)

- | | | |
|---------|---|---|
| 1. | } | Received items |
| 2. | | |
| 3. | } | No's |
| 4. | | |
| 5. | | |
| 6. | | |
| | | Rec. Clerk.  |

BELOW THIS LINE FOR OFFICE USE ONLY

Encumbrances not notified on face.

New Titles to issue or Endorsing instruction.

Amend Name of Building

Initials of Signing Officer.



Lodged on the day and time shown in and particulars entered in the Register Book.

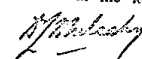

EXAMINED.



NT 153

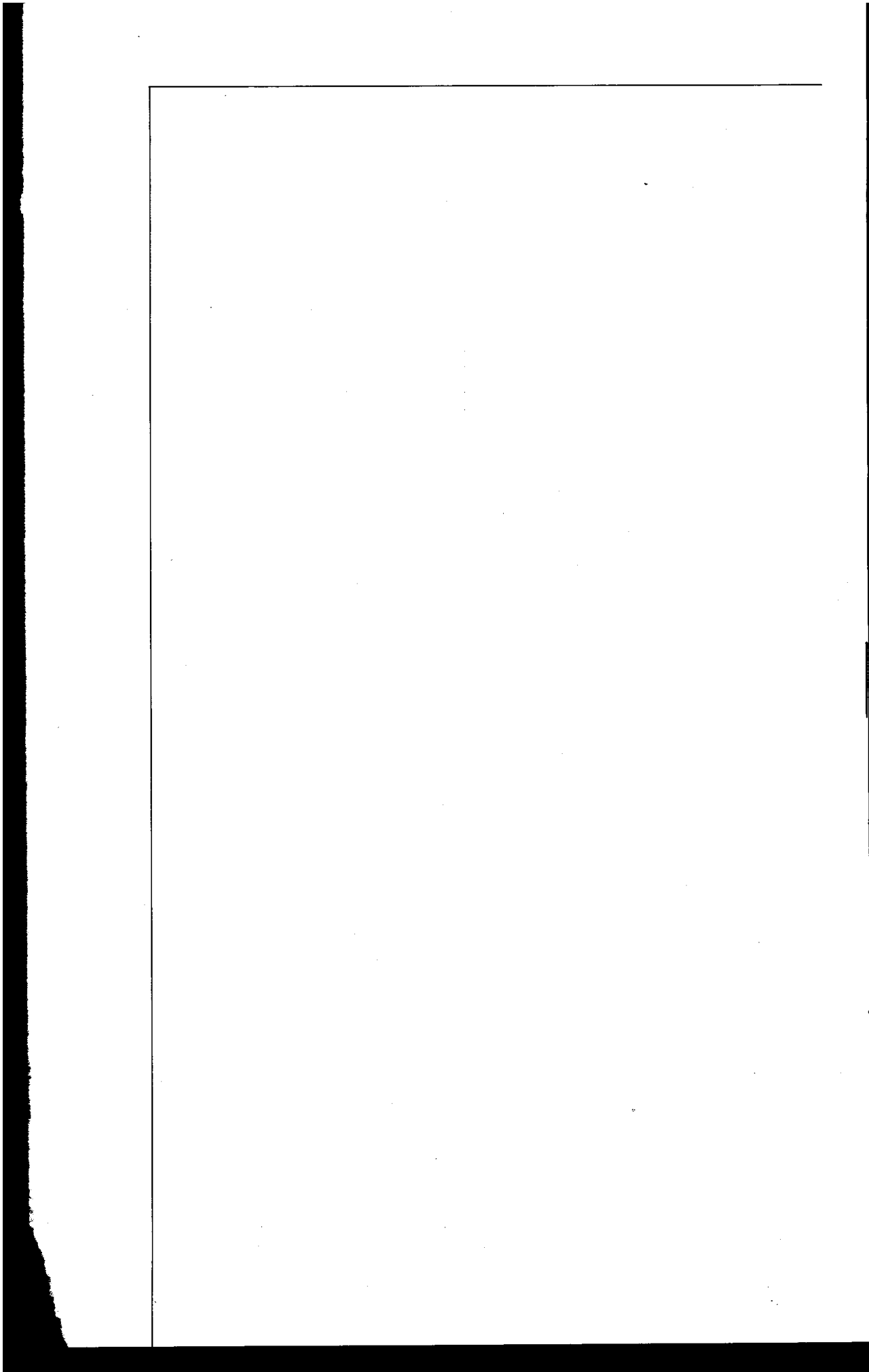

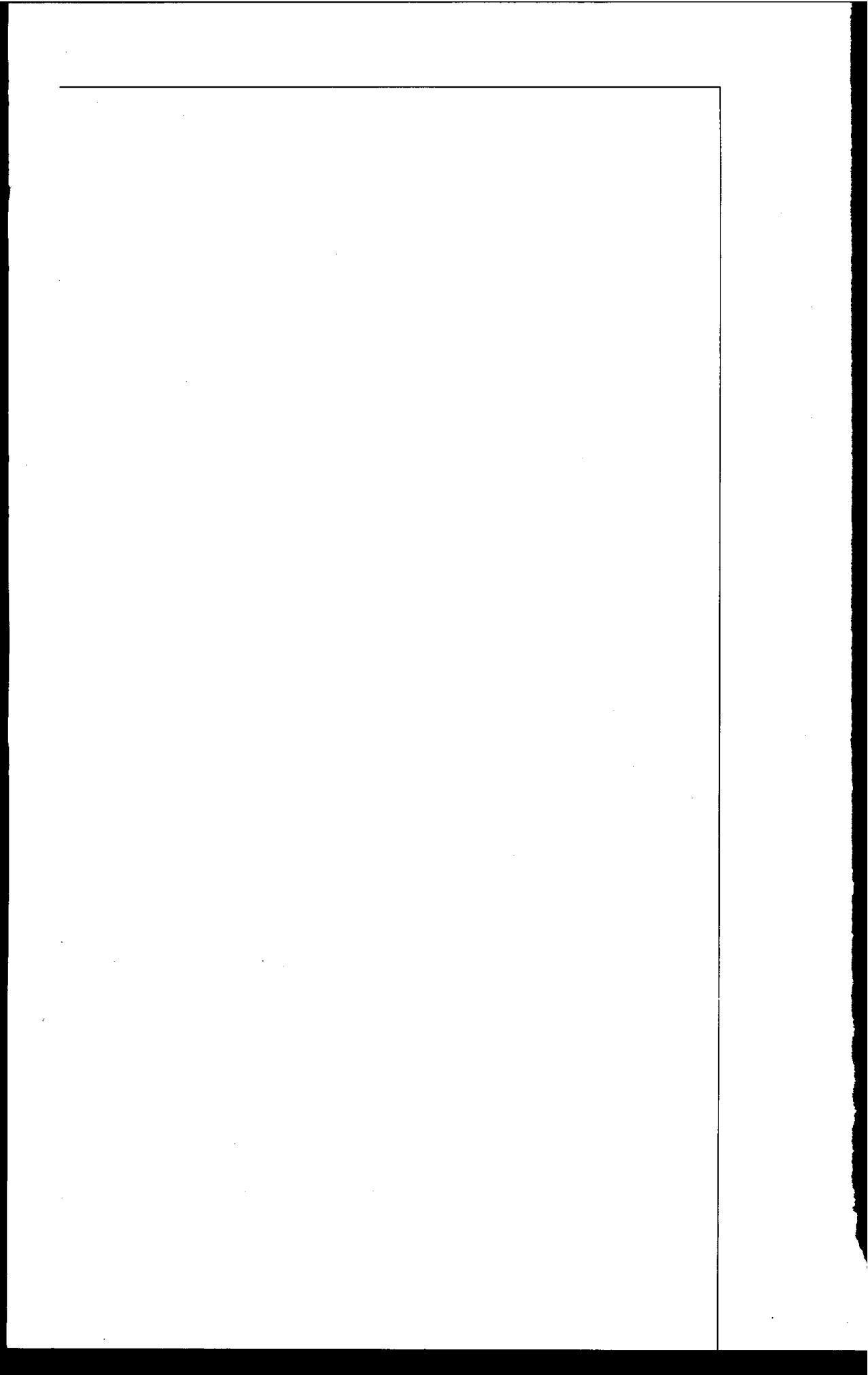

WESTERN AUSTRALIA.
Transfer of Land Act 1893 as amended
Blank Instrument Form (see footnote)

No.

a. Insert type of document here.

a.

NOTICE OF CHANGE OF NAME OF BUILDING

Strata Titles Act 1985

Section 41

The Owners of 98 Mandurah Terrace, Mandurah, Strata Plan No. 17133 hereby certifies that it has by special resolution resolved that the name of the building be changed:-

From The Owners of Brady's Resort Motel, Strata Plan 17133

To The Owners of 98 Mandurah Terrace, Mandurah, Strata Plan No. 17133

The Common Seal of The Owners of Brady's Resort Motel, Strata Plan No. 17133 was hereunto affixed on in the presence of:-

CHAIRMAN *B.A. Kemp*.....
SECRETARY *D. Smith*.....
TREASURER *A. H. H. H.*.....

MEMBERS OF COUNCIL



GARRY L. DUFFIELD
GOVERNMENT
PRINTER
WESTERN AUSTRALIA
©

NOTE: This Form may be used only when the "Box Type" Form is not suitable. It may be completed in narrative style.

F 543497 NA
09 May, 1994 14:25 Midland



LODGED BY A.J. MALONE
ADDRESS 3/132 FLINDERS STREET
YOKINE WA 6060
PHONE No. 3447013
FAX No. 3447013
REFERENCE No. B

ISSUING BOX No.

PREPARED BY

ADDRESS

PHONE No.

FAX No.

INSTRUCT IF ANY DOCUMENTS ARE TO ISSUE TO OTHER THAN
LODGING PARTY.

Book 25 F 000086 F
1 A 11/5

TITLES, LEASES, DECLARATIONS ETC. LODGED HERewith

- 1. _____ Received Items
- 2. _____ Nos.
- 3. _____
- 4. _____
- 5. _____
- 6. _____ Receiving Clerk *[Signature]*

ENDORISING INSTRUCTION

AA

EXAMINED

[Signature]

Registered pursuant to the provisions of the TRANSFER OF LAND ACT 1893 as amended on the day and time shown above and particulars entered in the Register Book.

INITIALS OF
SIGNING
OFFICER

[Signature]

NT153
CG Sack 7

REGISTRAR OF TITLES

FORM 17.
NOTICE OF CHANGE OF ADDRESS.
Strata Titles Act 1985.
Section 40.

The Owners of 98 Mandurah Terrace Strata Plan No 17133 hereby gives notice that the address endorsed on Strata Plan No 17133 at which documents may be served on the Company has now been changed to-
3/132 Flinders Street
Yokine WA 6060

The Common Seal of the Owners of 98 Mandurah Terrace Strata Plan No 17133 was hereunto affixed on 9th May 1994 in the presence of-

.....
A.J. MALONE (Treasurer)
Member of the Council

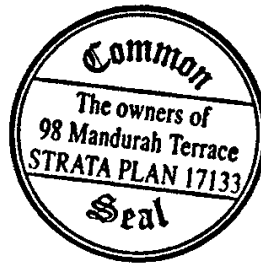

Council Member

FILE COPY DO NOT DESTROY

FILE COPY DO NOT DESTROY

STOPPED DOCUMENT DISPOSAL INSTRUCTIONS

Fees to be Refunded \$ _____

Form 10 No _____

Date ___/___/19___

To _____

Parties _____

Document Numbers _____

Computer Records Adjusted

Docs to be Withdrawn:

Docs to be Rejected:

Docs for Registration:

Authorised by: 

STOPPED CASE:

543497

ORIG. Cs/T:

SP17133

NOTICE SENT:

10/6/94

ACTION:

192 sent encl plus 12/7

EXAMINATION INSTRUCTIONS

Allocate New C/T

Complete Norm. Index

Pass to *NT 173*

Other _____

Examiner *A MacPherson CP2*

Supervisor *W. Jones*



DOCUMENT NOS F523497
YOUR REF J.P. 17133
DATE 10/6/94

REQUISITION NOTICE

Section 192 of The Transfer of Land Act

FIRST AND FINAL

ALL ENQUIRIES TO STOPPED DOCUMENT SECTION

A. J. Malone
3/132 Flinders St,
Yokine WA 6060

FAX (344 7013)

REGISTRATION OF THE ABOVE DOCUMENTS CANNOT BE EFFECTED UNTIL THE REQUISITIONS LISTED BELOW ARE COMPLIED WITH:

1. Unless these items are satisfied within 21 Days the Documents will be rejected and one half of the registration fee forfeited.
2. Documents may be withdrawn from registration for which a fee will be retained. The balance of the fees will be refunded.
3. Where a requisition fee is indicated the amount shown as the total is required to be paid before registration can proceed.

Doc. No.		Req. Fee.
<u>497</u>	<u>Two members of council to sign for Council Seal.</u>	
		\$
		\$
		\$
		\$
Total		\$ <u>Nil</u>

G.H. SACH
REGISTRAR OF TITLES

LAND TITLES DIVISION
Telephone: (09) 273 7337 • Fax (09) 273 7658
MIDLAND SQUARE, MIDLAND WESTERN AUSTRALIA • Postal Address: PO Box 2222, Midland WA 6056

F 729753 AE

15 Nov, 1994 14:24 Midland



LODGED BY Ashley Malone
ADDRESS PO Box 1386.
BUNBURY 6231.

PHONE No.

FAX No.

REFERENCE No.

ISSUING BOX No.

PREPARED BY

ADDRESS

PHONE No.

FAX No.

INSTRUCT IF ANY DOCUMENTS ARE TO ISSUE TO OTHER THAN LODGING PARTY.

OFFICE OF TITLES

15 NOV 1994

RECEIVED BY POST

TITLES, LEASES, DECLARATIONS ETC. LODGED HEREWITH

- 1. Letter Received Items
- 2. _____
- 3. _____ Nos. 1
- 4. _____
- 5. _____
- 6. _____ Receiving Clerk /

ENDORISING INSTRUCTION

*change address
no fees. S/Plan*

EXAMINED

Registered pursuant to the provisions of the TRANSFER OF LAND ACT 1893 as amended on the day and time shown above and particulars entered in the Register Book.

INITIALS OF SIGNING OFFICER

*NT 15 3
C/Sack 7*

REGISTRAR OF TITLES

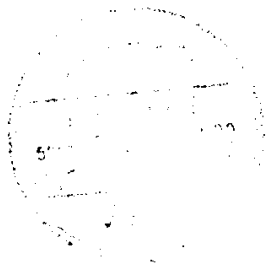

FORM 17.
NOTICE OF CHANGE OF ADDRESS.
Strata Titles Act 1985.
Section 40.

The Owners of 98 Mandurah Terrace Strata Plan No 17133 hereby gives notice that the address endorsed on Strata Plan No 17133 at which documents may be served on the Company has now been changed to-

PO Box 1386
BUNBURY WA 6231

The Common Seal of the Owners of 98 Mandurah Terrace Strata Plan No 17133 was hereunto affixed on 8th November 1994 in the presence of-



.....
A.J. MALONE (Treasurer)
Member of the Council

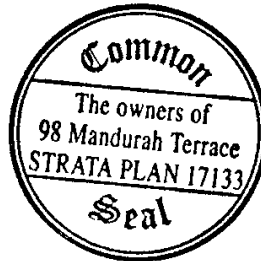

.....
J.B. SHEAHAN
Member of the Council

AXED



FAXED 10/11/94
Total - 2 pages

FAXED

Owners of 98 Mandurah Tce
Strata Plan 17133
PO Box 1386
BUNBURY WA 6231

10 November 1994



Registrar Of Titles
Department of LAND ADMINISTRATION
PO Box 2222
MIDLAND WA 6056

FACSIMILE (09) 273 7652

Dear Sir/Madam

RE: Change of Address for Notices (Strata Plan 17133)

Attached, please find the appropriate form advising the change of address for the above Strata Company.

I will forward the original, by post, to your office.

Thankyou for your assistance, and should you require further information please contact me.

Yours faithfully

ASHLEY MALONE
TREASURER
Home Phone/Fax (097) 219 890
Work (097) 21 4466

INSTRUCTIONS

1. This form may be used only when a "Box Type" Form is not provided or is unsuitable. It may be completed in narrative style.
2. If insufficient space hereon Additional Sheet, Form B1, should be used.
3. Additional Sheets shall be numbered consecutively and bound to this document by staples along the left margin prior to execution by the parties.
4. No alteration should be made by erasure. The words rejected should be scored through and those substituted typed or written above them, the alteration being initialled by the persons signing this document and their witnesses.

NOTES

1. Insert document type.
2. A separate attestation is required for every person signing this document. Each signature should be separately witnessed by an Adult person. The address and occupation of the witness must be stated.

G 91789 AE
02 Feb, 1996 16:30 Midland



REG. \$ 62.00

TIME CLOCK

LODGED BY **ADMINISTRATION MANAGER**

STRATA PLAN 17133

ADDRESS

P.O. BOX 1386

BUNBURY W.A. 6231

PHONE No.

(097) 219 890

FAX No.

(097) 219 890

REFERENCE No.

ISSUING BOX No.

PREPARED BY

A.J MALONE
TREASURER

ADDRESS

PO BOX 1386
BUNBURY WA 6231

PHONE No. *(097) 219 890* FAX No. *(097) 219 890*

INSTRUCT IF ANY DOCUMENTS ARE TO ISSUE TO OTHER THAN LODGING PARTY.

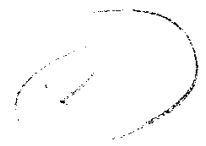

TITLES, LEASES, DECLARATIONS ETC. LODGED HEREWITH

1. _____ Received Items
2. _____ Nos.
3. _____
4. _____
5. _____ Receiving Clerk
6. _____

ENDORISING INSTRUCTION

Change Name SP

EXAMINED

[Signature]

INITIALS OF SIGNING OFFICER

[Signature] **6**

REGISTRAR OF TITLES

05390/1/92-5M-OC/664



BLANK INSTRUMENT FORM

(Note 1)

FORM 18.

NOTICE OF CHANGE OF NAME OF BUILDING.
Strata Titles Act 1985.

Section 41.

The Owners of 98 Mandurah Terrace Mandurah Strata Plan No. 17133 hereby certifies that it has by special resolution resolved that the name of the building be changed -
From THE OWNERS OF 98 MANDURAH TERRACE MANDURAH
To THE OWNERS OF MANDURAH TERRACE APARTMENTS.

The Common Seal of
The Owners of 98 Mandurah Terrace Mandurah
Strata Plan No. 17133
was hereunto affixed
on the 2nd day of February 1996
in the presence of:



J.B. SHEAHAN
Councillor

Witness W.A. Parkey

Name W A PARKEY

Occupation SECURITY OFFICER

Dated 2-2-96

A.J. MALONE
Councillor

Witness Christine Malone

Name CHRISTINE MALONE

Occupation SALES SECRETARY /
PRODUCTION CO-ORDINATOR

Dated 2/2/96

INSTRUCTIONS

1. This form may be used only when a "Box Type" form is not provided or is unsuitable. It may be completed in narrative style.
2. If insufficient space hereon Additional Sheet Form B1 should be used.
3. Additional Sheets shall be numbered consecutively and bound to this document by staples along the left margin prior to execution by the parties.
4. No alteration should be made by erasure. The words rejected should be scored through and those substituted typed or written above them, the alteration being initialled by the persons signing this document and their witnesses.

NOTES

1. Insert document type.
2. A separate attestation is required for every person signing this document. Each signature should be separately witnessed by an Adult Person. The address and occupation of the witness must be stated.

G 789059 NA

11 May, 1998 15:07:58 Midland



REG. \$ 60.00

LODGED BY

ASHLEY MALONE

ADDRESS

*PO BOX 1058
CANNING BRIDGE WA 6153*

PHONE No.

(08) 9364 2764

FAX No.

(08) 9364 2764

REFERENCE No.

ISSUING BOX No.

PREPARED BY

ADMINISTRATION MANAGER

ADDRESS

*PO BOX 1058
CANNING BRIDGE WA 6153*

PHONE No.

(08) 9364 2764

FAX No. *(08) 9364 2764*

INSTRUCT IF ANY DOCUMENTS ARE TO ISSUE TO OTHER THAN LODGING PARTY

TITLES, LEASES, DECLARATIONS ETC LODGED HEREWITH

1. _____ Received Items
2. _____ Nos.
3. _____
4. _____
5. _____
6. _____ Receiving Clerk

Registered pursuant to the provisions of the TRANSFER OF LAND ACT 1893 as amended on the day and time shown above and particulars entered in the Register.

EXAMINED

Amend ADDRESS

[Signature]

P



VEGT

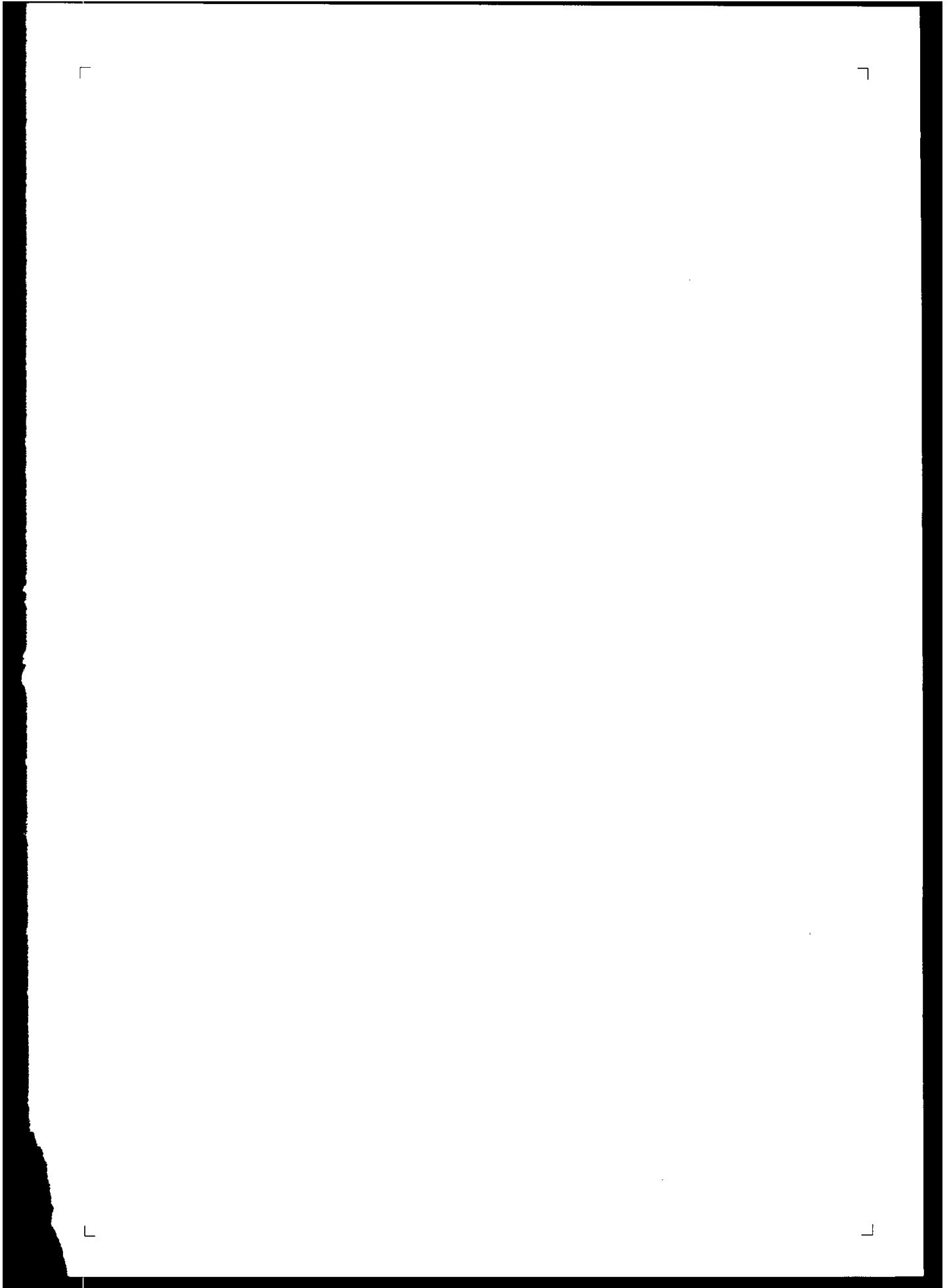



BLANK INSTRUMENT FORM

┌
├
└

┐
┘

(Note 1)

FORM 15/16

[Signature]
Assist. Registrar of Titles
14-5-98

NOTICE OF CHANGE OF ADDRESS FOR SERVICE OF NOTICES.
Strata Titles Act 1985.

Section 40.

The Owners of Mandurah Terrace Apartments Strata Plan No. 17133 hereby gives notice that the address for service of notices on the Company has been changed to -
PO Box 1058 CANNING BRIDGE WA 6153

The Common Seal of
The Owners of Mandurah Terrace Apartments
Strata Plan No. 17133
was hereunto affixed
on the 11th day of May 1998
in the presence of:



[Signature]

RONALD ALEXANDER BULLEN
Councillor

Witness *[Signature]*

Name PIONA JOY BALLANTYNE

Occupation ACCOUNTANT

Dated 11 May 1998.

[Signature]

ASHLEY JOHN MALONE
Councillor

Witness *[Signature]*

Name CHRISTINE RAE MALONE

Occupation SECRETARY

Dated 11/5/98

┌

└

OFFICE USE ONLY

N824664 AE

06 Feb 2018 12:35:17 Perth



LODGED BY *SHEILA JACKSON*

ADDRESS *P O Box 982
MANDURAH WA 6210*

PHONE No. *(08) 95371315*

FAX No. *(08) 95371315*

REFERENCE No.

ISSUING BOX No. *888U*

PREPARED BY *Ian Laird*

ADDRESS *P O Box 139, Fremantle, 6959*

PHONE No. *9430 4468*

FAX No. *9430 9951*

INSTRUCT IF ANY DOCUMENTS ARE TO ISSUE TO OTHER THAN LODGING PARTY

2/2

TITLES, LEASES, DECLARATIONS ETC LODGED HEREWITH

1. _____	Received Items
2. _____	Nos.
3. _____	
4. _____	<i>RD</i>
5. _____	Receiving Clerk
6. _____	

Registered pursuant to the provisions of the TRANSFER OF LAND ACT 1893 as amended on the day and time shown above and particulars entered in the Register.

EXAMINED





Form 16

NOTICE OF CHANGE OF ADDRESS FOR SERVICE OF NOTICES

Strata Titles Act 1985

Section 40

The Owners of Mandurah Terrace Apartments Strata Plan 17133

hereby gives notice that the address for service of notices on the Company has now been changed to —

C/- P O BOX 982 MANDURAH WESTERN AUSTRALIA 6210

The Common Seal of The Owners of Mandurah Terrace Apartments Strata Plan 17133 was hereunto affixed on 1-2-18 in the presence of —

[Signature]Signature
RAQUEL TEMPORINIPrint name

[Signature]Signature
SHARLETT JARROLDPrint name

Members of the Council



INSTRUCTIONS

1. This form may be used only when a "Box Type" Form is not provided or is unsuitable. It may be completed in narrative style.
2. If insufficient space hereon Additional Sheet, Form B1, should be used.
3. Additional Sheets shall be numbered consecutively and bound to this document by staples along the left margin prior to execution by the parties.
4. No alteration should be made by erasure. The words rejected should be scored through and those substituted typed or written above them, the alteration being initialled by the persons signing this document and their witnesses.

NOTES

1. Insert document type.
2. A separate attestation is required for every person signing this document. Each signature should be separately witnessed by an Adult person. The address and occupation of the witness must be stated.

F 106181 NA
09 Feb, 1993 12:30



REG. \$ 62.00

TIME CLOCK

LODGED BY PAUL F WHITE

ADDRESS 3 CROWTHER ELBOW
OCEAN REEF WA

PHONE No. 268 5294

FAX No.

REFERENCE No.

ISSUING BOX No.

PREPARED BY

ADDRESS

PHONE No.

FAX No.

INSTRUCT IF ANY DOCUMENTS ARE TO ISSUE TO OTHER THAN LODGING PARTY:

*Endorsed by Law
17-2-93*

TITLES, LEASES, DECLARATIONS ETC. LODGED HERewith

1. _____ Received Items
2. _____ Nos.
3. _____
4. _____
5. _____
6. _____ Receiving Clerk

ENDORISING INSTRUCTION

EXAMINED

A

Registered pursuant to the provisions of the TRANSFER OF LAND ACT 1893 as amended on the day and time shown above and particulars entered in the Register Book.

INITIALS OF SIGNING OFFICER

[Signature]
LEG IT
REGISTRAR OF TITLES

REGISTRAR OF TITLES

05390/1/92-5M-OC/664

21. Insurance.

In accordance with Section 54(1) of the Strata Titles Act 1985, Insurance for structures in the complex is to be terminated in its present form and replaced by insurance as follows:-

- 21.1 Lots 59 and 60 to be arranged by their proprietor.
- 21.2 Lot 61 to be arranged by its proprietor.
- 21.3 Lot 62 to be arranged by its proprietor/Strata Company.
- 21.4 Lots 1 to 58 to be arranged by the Strata Company.
- 21.5 Strata Company to adjust levies according to the above.

22. Maintenance.

Maintenance for structures in the complex to be terminated in its present form and replaced by maintenance as follows:-

- 22.1 Lots 59 and 60 to be arranged by their proprietor.
- 22.2 Lot 61 to be arranged by its proprietor.
- 22.3 Lot 62 to be arranged by its proprietor/Strata Company.
- 22.4 Lots 1 to 58 to be arranged by the Strata Company.
- 22.5 Strata Company to adjust levies according to the above.
- 22.6 Strata Company reserves the right of approval for all external refurbishment of lots 1 to 62.

The Common Seal of the Owners of 98 Mandurah Terrace, Mandurah Strata Plan No. 17133 was hereunto affixed on 23rd January, 1993 in the presence of:-

[Handwritten Signature]
.....
Secretary

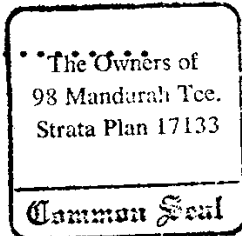

WITNESSED BY

[Handwritten Signature]
D J HENLEY (ACCOUNTANT)

[Handwritten Signature]
.....
TREASURER

WITNESSED BY

[Handwritten Signature]
D J HENLEY (ACCOUNTANT)

19.7 con't

- 19.7.3 Lots 1 to 58 where individual meters are installed - via meter reading.
 - 19.7.4 Where individual meters are not installed in lots not administered by Burdett Pty Limited (lots 10 & 11), by a special levy to be set by the Strata Company.
 - 19.7.5 Where lots are administered by Burdett Pty Limited, the balance of consumption.
- 19.8 All power to be charged at the aggregate SECWA rate for the respective month.

20. Gas & Hot Water Supply.

Due to the nature of the hot water supply, ie: via one gas fired boiler, the following to be adopted:

- 20.1 Proprietor of lot 61 to undertake to disconnect from existing hot water supply and ensure no heat losses are incurred, and ensure continuity of supply to lot 62.
- 20.2 Metering device to be installed to enable calculation of gas consumption between appliances in lots 59 and 60. eg: kitchen and the boiler.
- 20.3 A charge of \$60.00 per week, to be reviewed annually, to be met by the Strata Company, and paid to the proprietor of lot 59. The Strata Company to recoup this expense via adjustment of levies on lots 1 to 58. This levy to cover supply, repairs, maintenance and replacement of hot water system and all ancillary equipment.
- 20.4 Strata Company to take over hire of bulk gas container and reimburse Burdett Pty Limited for the unexpired portion of the current rental period.
- 20.5 Cost of all future gas purchases to be met by the Strata Company.
- 20.6 Strata Company to employ an independent person to administer gas purchases and re-charging.
- 20.7 Re-charging for gas consumption to be on the following basis:-
 - 20.7.1 Usage, lots 59 and 60 - via meter reading as per Section 20.2.
 - 20.7.2 Balance to be distributed on the basis of unit entitlement over the residential lots with the exception of those units with electric hot water units and Lot 62.

BLANK INSTRUMENT FORM

(Note 1)

FORM 22

NOTIFICATION OF CHANGE OF BY-LAWS

Strata Titles Act 1985

Section 42

The Owners of 98 Mandurah Terrace, Mandurah Strata Plan No. 17133 hereby certifies that by unanimous resolution duly passed on the 24th October, 1992 the by-laws in Part 1 of Schedule 1 to the Act as they applied to the building referred to in that strata plan, were added to, amended, or repealed as follows-

17. No further electric hot water systems to be installed in residential units Numbers 1 to 58 of 98 Mandurah Terrace after this date.
18. No proprietor to be given permission to keep animals after this date, notwithstanding Section 42(15) of the Strata Titles Act 1985.
19. Power Supply & Metering.

To resolve the problems related to the metering of electricity, the following to be adopted:

- 19.1 In the event of a sale of any of the Lots 1 to 58, supply to be via a separate meter installed in a suitable location.
- 19.2 Supply to Lots 59 and 60 and 61 to be metered via separate meters installed in a suitable location.
- 19.3 Supply in the name of Burdett Pty Limited (Mandurah Terrace Motel) to be terminated.
- 19.4 Supply to be re-commenced in the name of Strata Company 17133.
- 19.5 Deposit currently held by SECWA to be refunded to Burdett by the Strata Company which will levy all proprietors on the basis of unit entitlement for the required deposit.
- 19.6 Strata Company to employ an independent person to administer power meter reading, and the subsequent re-charging of proprietors.
- 19.7 Re-charging of proprietors for power consumption to be on the following basis:-
 - 19.7.1 Lots 59 and 60 - via meter reading.
 - 19.7.2 Lots 61 and 62 - via meter reading.

FILE COPY DO NOT DESTROY

FILE COPY DO NOT DESTROY

STOPPED CASE:— 106181

STOPPED DOCUMENT DISPOSAL INSTRUCTIONS

ORIG. Cs/T:— SIP 17133

Fees to be Refunded \$ _____

Form 10 No _____

Date ____/____/19____

To _____

Parties _____

Document Numbers _____

Computer Records Adjusted

NOTICE SENT:— 12 FEB 1993

ACTION:—

Docs to be Withdrawn:—

Docs to be Rejected:—

Docs for Registration:—

Authorised by:—

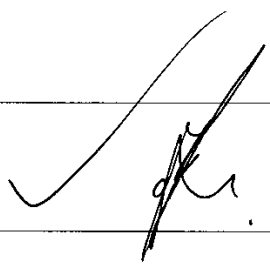

EXAMINATION INSTRUCTIONS

Allocate New C/T

Complete Nom. Index

Pass To _____

Other _____

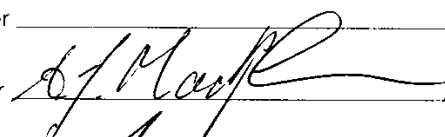
Examiner 

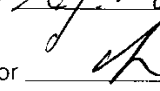
Supervisor 

OFFICE OF TITLES

DOCUMENT NOS 181201 1106131YOUR REF J.R.1133DATE 22-8-98**REQUISITION NOTICE**

Section 192 Of The Transfer Of Land Act

FIRST AND FINALALL ENQUIRIES TO STOPPED DOCUMENT SECTION

POST

12. F. White
3 CROWTHER ELBOW
OCEAN REEF 6027

**REGISTRATION OF THE ABOVE DOCUMENTS CANNOT BE EFFECTED
UNTIL THE REQUISITIONS LISTED BELOW ARE COMPLIED WITH:**

1. Unless these items are satisfied within 21 Days the Documents will be rejected and one half of the registration fee forfeited.
2. Documents may be withdrawn from registration for which a fee will be retained. The balance of the fees will be refunded.
3. Where a requisition fee is indicated the amount shown as the total is required to be paid before registration can proceed.

Doc. No.

Req. Fee.

181to be paid to show name of
Suburb (Mandurah)

Accept deal
in this instance

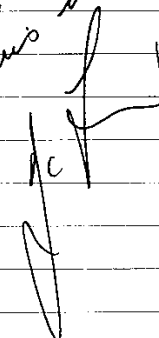

Total

\$

N/AD.L. MULCAHY
REGISTRAR OF TITLES

Telephone: (09) 222 6888 & 222 6833 • Fax (09) 222 6830

'LAW CHAMBERS' CATHEDRAL SQUARE, PERTH • Postal Address: G.P.O. Box W2107, Perth, 6001

097971/93—9M—S/11722

INSTRUCTIONS

1. This form may be used only when a "Box Type" Form is not provided or is unsuitable. It may be completed in narrative style.
2. If insufficient space hereon Additional Sheet, Form B1, should be used.
3. Additional Sheets shall be numbered consecutively and bound to this document by staples along the left margin prior to execution by the parties.
4. No alteration should be made by erasure. The words rejected should be scored through and those substituted typed or written above them, the alteration being initialled by the persons signing this document and their witnesses.

F 937504 A



62

APPLICATION

15 10 12 100

TIME CLOCK

NOTES

1. Insert document type.
2. A separate attestation is required for every person signing this document. Each signature should be separately witnessed by an Adult person. The address and occupation of the witness must be stated.

LODGED BY THE OWNERS OF 98 MANDURAH TERRACE
 MANDURAH STRATA PLAN 17133
 ATTENTION: ASHLEY MALONE
 ADDRESS PO BOX 1386
 BUNBURY WA 6231

PHONE No. (097) 219 890

FAX No. (097) 219 890

REFERENCE No.

ISSUING BOX No.

PREPARED BY A.J. MALONE - TREASURER
 THE OWNERS OF 98 MANDURAH TERRACE
 MANDURAH STRATA PLAN 17133
 ADDRESS PO BOX 1386
 BUNBURY WA 6231

PHONE No. (097) 219 890 FAX No. (097) 219 890

INSTRUCT IF ANY DOCUMENTS ARE TO ISSUE TO OTHER THAN LODGING PARTY.

*Please endorse amendment of
 By laws pursuant to section
 42 of the Strata Titles Act
 1985. from 28/8/95.*

(1)

TITLES, LEASES, DECLARATIONS ETC. LODGED HEREWITH

1.	_____	Received Items
2.	_____	Nos.
3.	_____	
4.	_____	
5.	_____	
6.	_____	Receiving Clerk

ENDORISING INSTRUCTION

EXAMINED

16

Registered pursuant to the provisions of the TRANSFER OF LAND ACT 1893 as amended on the day and time shown above and particulars entered in the Register Book.

INITIALS OF SIGNER OFFICER

[Signature]

CJ Sach **6600**
REGISTRAR OF TITLES

36. Breaches of By-laws

Any costs incurred from a breach of the By-Laws by a proprietor, occupier, other resident, or their guests is to be paid for by the proprietor of the Lot who committed the breach or whose occupier, other resident, or guest committed the breach.

Breaches of this nature can be, but are not limited to the following:

- . Security call out
- . Clean up of rubbish
- . Repair of damage to common property
- . Towing costs of vehicles

The Common Seal of
The Owners of 98 Mandurah Terrace
Mandurah Strata Plan No. 17133
was hereunto
affixed on the 17th day of AUGUST 1995
in the presence of:

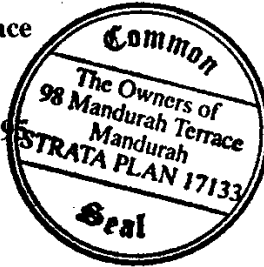

J.B. Sheahan

J.B. Sheahan
Councillor

A.J. Malone

A.J. Malone
Councillor

Witness *Christine Malone*
 Name CHRISTINE MALONE
 Occupation PRODUCTION CO-ORDINATOR
 Address 10/13 UPPER ESPLANADE
 SUNBURY WA 6230
 Dated 17/8/95

Witness *Godfrey MALONE*
 Name Godfrey MALONE
 Occupation Police Officer
 Address 7 Seapeak Rd
 Ocean Reef F.
 Dated 17/08/95

- 4 -

32. Building Maintenance

- (a) Lots 1 to 58 external building maintenance is arranged by the Strata Company. In normal circumstances this maintenance will be paid for by the Strata Company, but in exceptional circumstances a levy may be required to meet the costs.
- (b) Lots 59 to 62 internal and external building maintenance is arranged by and paid for by the proprietors of those Lots.
- (c) The Strata Company reserves the right of approval for all external refurbishment of Lots 1 to 62.

33. Common Area Maintenance

- (a) Driveways and all rear common areas are maintained by the Strata Company. In normal circumstances this maintenance will be paid for by the Strata Company, but in exceptional circumstances a levy may be required to meet the costs.
- (b) The proprietor of Lots 59 & 60 is responsible for the maintenance and associated costs in respect to the common area at the front of those Lots.
- (c) The proprietor of Lots 61 & 62 is responsible for the maintenance and associated costs in respect to the common areas at the front of and beside those Lots.

34. Building Insurance

- (a) Building insurance for Lots 1 to 58 is arranged by and paid for by the Strata Company.
- (b) Building insurance for Lots 59 to 62 is arranged by and paid for by their proprietors.

35. Levies

- (a) Lots (Units) 1 to 58 pay a quarterly levy to the Strata Company. This levy is determined each year during budget preparation.
- (b) Lots (Units) 59 to 62 do not pay levies to the Strata Company but are responsible for the following -
 - . All power charges associated with their Lots including common area lighting.
 - . All building maintenance costs both internal and external for their Lots.
 - . All common area garden and ground maintenance at the front of and beside their Lots.
 - . All common area lighting maintenance at the front of and at the side of their Lots.
 - . Arrangement of their garbage collections.
 - . Arrangement of their building insurance.

..J5..

WESTERN AUSTRALIA
TRANSFER OF LAND ACT 1893 AS AMENDED.

ADDITIONAL PAGE TO

Dated 17TH AUGUST 1995

- 3 -

28. Hot Water Supply

The gas fired boiler supplying hot water to Lots 1 to 60 is located in Lot 59 and owned by that proprietor.

A charge which is reviewed annually is met by the Strata Company and paid to the proprietor of Lot 59 to cover all running (excluding gas) and maintenance costs associated with the boiler and circulating pumps.

29. Gas

The Strata Company is responsible for the hire of the bulk gas cylinder which supplies gas to the hot water boiler and Lot 59.

The cost of gas which is purchased by the litre is met by the Strata Company.

Lot 59 is supplied via a sub-meter and is charged for the consumption which is registered on that meter in cubic metres.

Cost per cubic metre = Cost per litre x 3.67.

(3.67 litres of LPG produces one cubic metre of gas).

30. Water

(a) Lots 1 to 60 are supplied via a common meter. Consumption costs are apportioned as follows.

Lots 1 to 58 - 67% of total cost.

Lots 59 & 60 - 33% of total cost.

(b) Lots 61 & 62 are supplied via their own meter and are responsible for payment of the consumption registered on that meter.

31. Mail Boxes

The proprietors of Lots 1 to 58 agree that no Mail Boxes are provided, or will be constructed, or placed on the common property.

..4..

23. Children

A proprietor, occupier, or other resident of a Lot or their guests shall not permit any child of whom he/she has control to play upon common property within the building or, unless accompanied by an adult exercising effective control, to be or to remain upon common property comprising a laundry, car parking area or other area of possible danger or hazard to children.

24. Rubbish

A proprietor, occupier, or other resident of a Lot or their guests shall not deposit or throw upon the common property any rubbish, dirt, dust or other material likely to interfere with the peaceful enjoyment of the proprietor, occupier, or other resident of another Lot or of any person lawfully using the common property.

25. Signs

A proprietor, occupier, or other resident of a Lot shall not, except with the written consent of the Strata Company, display or have displayed on his behalf, any sign, advertisement, placard, banner, pamphlet or like matter on any part of his Lot in such a way as to be visible from outside the building, or displayed on any common property.

26. Glass

A proprietor, occupier, or other resident of a Lot shall keep clean all glass in all windows and all doors on the boundary of the Lot.

27. Electricity

Charging of proprietors for power consumption is on the following basis.

- (a) Lots 1 to 58 - current SECWA rate plus 2 cents per unit to cover a portion of the common power costs.
- (b) Lots 59 - 62 - current SECWA rate.

Common area power consumption is paid for as follows:

- (c) Lots 1 to 58 common area power consumption (passage way and car park lighting) costs are recouped by an additional 2 cents per unit charge plus a monthly levy.
- (d) Lots 59 - 62 common area power consumption (external area and car park lighting adjacent to their Lots) is registered on their meters and paid for by them.
- (e) The power consumption costs for the pool, spa and sauna is paid for by the Strata Company.

./3..

BLANK INSTRUMENT FORM

(Note 1)

Notification of Change of By-Laws
Strata Titles Act 1985

The Owners of 98 Mandurah Terrace Mandurah Strata Plan 17133 hereby certify that by unanimous resolution, duly passed on the 17th June 1995, the By-Laws in Part 1 of Schedule 1 to the Act, as they applied to the building referred to in that Strata Plan, were added to, amended, or repealed as follows:

It is proposed to delete By-Laws 17 to 22 in Part 1 of Schedule 1, put in place by the Strata Company on 23rd January 1993, and replace them with the following:

Schedule 1 - Part 1 By-Laws**17. Parking**

- (a) Parking is not permitted in any place other than the designated, marked parking bays.
- (b) The parking areas are not to be used for any purpose other than the parking of vehicles unless prior written approval has been given by the Strata Company.

18. Gardens

A proprietor, occupier, or other resident shall not:

- (a) damage any lawn, garden, tree, shrub, plant or flower upon common property, or
- (b) use any portion of the common property for their own purpose as a garden.

19. Clothes Lines

Clothes lines, either temporary or permanent are prohibited in common areas.

20. Animals

Animals are not permitted to be kept in any Lot, or be on any Lot or common property.

21. Hot Water Systems

No additional electric hot water systems are permitted to be installed in Lots 1 to 58.

22. Behaviour

A proprietor, occupier, or other resident of a Lot or their guests shall be adequately clothed when upon common property and shall not use language or behave in a manner likely to cause offence or embarrassment to the proprietor, occupier, or other resident of another Lot or to any person lawfully using common property.

..12..

INSTRUCTIONS

1. This form may be used only when a "Box Type" Form is not provided or is unsuitable. It may be completed in narrative style.
2. If insufficient space hereon Additional Sheet, Form B1, should be used.
3. Additional Sheets shall be numbered consecutively and bound to this document by staples along the left margin prior to execution by the parties.
4. No alteration should be made by erasure. The words rejected should be scored through and those substituted typed or written above them, the alteration being initialled by the persons signing this document and their witnesses.

NOTES

1. Insert document type.
2. A separate attestation is required for every person signing this document. Each signature should be separately witnessed by an Adult person. The address and occupation of the witness must be stated.

*Endorse amendment of
Strata Company Bylaws
on SP 17133*

[Signature]
12-2-96

ENDORISING INSTRUCTION

By laws.

EXAMINED

[Signature]

05390/1/92-5M-OC/664

G 91790 AE

02 Feb, 1996 16:30 Midland

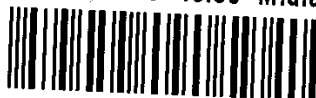

REG. \$ 62.00

TIME CLOCK

LODGED BY

ADMINISTRATION MANAGER

ADDRESS

STRATA PLAN 17133

P.O. BOX 1386

BUNBURY W.A. 6231

PHONE No.

(097) 219 890

FAX No.

(097) 219 890

REFERENCE No.

ISSUING BOX No.

PREPARED BY

*A.J. MALONE
TREASURER*

ADDRESS

*PO BOX 1386
BUNBURY WA 6231*

PHONE No.

(097) 219 890

FAX No. *(097) 219 890*

INSTRUCT IF ANY DOCUMENTS ARE TO ISSUE TO OTHER THAN LODGING PARTY.

TITLES, LEASES, DECLARATIONS ETC. LODGED HEREWITH

1. _____ Received Items
2. _____ Nos.
3. _____
4. _____
5. _____
6. _____ Receiving Clerk

Registered pursuant to the provisions of the TRANSFER OF LAND ACT 1893 as amended on the day and time shown above and particulars entered in the Register Book.

INITIALS OF SIGNING OFFICER

*U.G. OC
[Signature]*

REGISTRAR OF TITLES

36. Breaches of By-Laws

Any costs incurred from a breach of the By-Laws by a proprietor, occupier, other resident, or their guests is to be paid for by the proprietor of the Lot who committed the breach or whose occupier, other resident, or guest committed the breach.

Breaches of this nature can be, but are not limited to the following:

- . Security call out
- . Clean up of rubbish
- . Repair of damage to common property
- . Towing costs of vehicles

The Common Seal of
 The Owners of 98 Mandurah Terrace
 Mandurah Strata Plan No. 17133
 was hereunto
 affixed on the 2ND day of FEBRUARY 1961
 in the presence of:

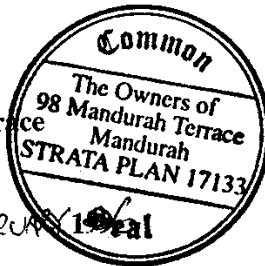

J.B. Sheahan
 J.B. Sheahan
 Councillor

Witness WA Parkey
 Name WA PARKEY
 Occupation SECURITY OFFICER
 Address ALCOA DRIVE
 NTH PINJARRA.
 Dated 2.2.96

A.J. Malone
 A.J. Malone
 Councillor

Witness Christine Malone
 Name CHRISTINE MALONE
 Occupation SALES SECRETARY/
 PRODUCTION CO-ORDINATOR
 Address UNIT 10/13 UPPER ESPLANADE
 BUNBURY WA
 Dated 2/2/96

31. Mail Boxes

The Proprietors of Lots 1 - 58 agree that no mail boxes are provided, or will be constructed, or placed on the common property.

32. Building Maintenance

- (a) Lots 1 to 58 external building maintenance is arranged by the Strata Company. In normal circumstances this maintenance will be paid for by the Strata Company, but in exceptional circumstances a levy may be required to meet the costs.
- (b) Lots 59 to 62 internal and external building maintenance is arranged by and paid for by the proprietors of those Lots.
- (c) The Strata Company reserves the right of approval for all external refurbishment of Lots 1 to 62.

33. Common Area Maintenance

- (a) Driveways and all rear common areas are maintained by the Strata Company. In normal circumstances this maintenance will be paid for by the Strata Company, but in exceptional circumstances a levy may be required to meet the costs.
- (b) The proprietor of Lots 59 & 60 is responsible for the maintenance and associated costs in respect to the common area at the front of those Lots.
- (c) The proprietor of Lots 61 & 62 is responsible for the maintenance and associated costs in respect to the common areas at the front of and beside those Lots.

34. Building Insurance

- (a) Building insurance for Lots 1 to 58 is arranged by and paid for by the Strata Company.
- (b) Building insurance for Lots 59 to 62 is arranged by and paid for by their proprietors.

35. Levies

- (a) Lots (Units) 1 to 58 pay a quarterly levy to the Strata Company. This levy is determined each year during budget preparation.
- (b) Lots (Units) 59 to 62 do not pay levies to the Strata Company but are responsible for the following -
 - . All power charges associated with their Lots including common area lighting.
 - . All building maintenance costs both internal and external for their Lots.
 - . All common area garden and ground maintenance at the front of and beside their Lots.
 - . All common area lighting maintenance at the front of and at the side of their Lots.
 - . Arrangement of their garbage collections.
 - . Arrangement of their building insurance.

..15..

ADDITIONAL PAGE TO

Dated

- 3 -

27. Electricity

The Strata Company bills Lot proprietors for any power consumption on the following basis:

- (a) Lots 1 to 58 are charged at a rate 2 cents higher than the applicable Western Power rate.
- (b) The cost of power consumption in common areas, for passage, car park, and security lighting adjacent to Lots 1 - 58, is recouped through the surcharge of 2 cents, plus an additional monthly charge known as the Common Power Levy which is determined by the Strata Company Council on an annual basis.
- (c) The Strata Company is not responsible for paying the cost of Electricity consumed on Lots 59 - 62, which have separate Western Power metering.
- (d) Power consumption costs for the Pool Area are paid for by the Strata Company, provided the proprietors of Lots 1 - 58 have responsibility for maintenance, security and use of the pool facilities.

28. Hot Water Supply

The gas fired boiler supplying hot water to Lots 1 to 60 is located in Lot 59 and owned by that proprietor.

A charge which is reviewed annually is met by the Strata Company and paid to the proprietor of Lot 59 to cover all running (excluding gas) and maintenance costs associated with the boiler and circulating pumps.

29. Gas

- (a) The Strata Company is responsible for hire of the LPG gas storage tank, which supplies gas to the hot water boiler and Lot 59.
- (b) The Strata Company recovers the cost of gas consumption and annual maintenance of the storage facility, through Strata Levies paid by the proprietors of Lots 1 - 58 and apportionment of charges to the proprietor and/or lessee of Lots 59 & 60 based on gas used for cooking purposes, to heat hot water supplied to Lots 59 & 60, and an annually reviewed percentage of the gas cylinder maintenance fee.

30. Water

- (a) Lots 1 to 60 are supplied via a common meter, and the apportionment of costs are determined annually by the Strata Company and the proprietor of Lots 59 & 60.
- (b) Lots 61 & 62 are supplied via their own meter, and are responsible for their own consumption costs.

..14..

- (c) Not cause any noise which disturbs other residents.
- (d) Not damage or mistreat any Common Property, Pool Area Furniture, Pool Equipment, Pool Structure, or general Building Structure.
- (e) Comply with the following Pool Rules:
 - Open 8am to 8pm only.
 - For the use of residents and owners only.
 - Keep your children under supervision at all times while they are using the pool.
 - Do not bring glass into the pool enclosure.
 - Consider safety by not running in the pool area.
 - No "bommies" or dangerous diving.
 - Sauna users must shower before using the pool.
- (f) Not store, hang, or leave any property, clothes, or personal effects on the common area.

23. Children

A proprietor, occupier, or other resident of a Lot or their guests shall not permit any child of whom he/she has control to play upon common property within the building or, unless accompanied by an adult exercising effective control, to be or to remain upon common property comprising a laundry, car parking area or other area of possible danger or hazard to children.

24. Rubbish

A proprietor, occupier, or other resident of a Lot or their guests shall not deposit or throw upon the common property any rubbish, dirt, dust or other material likely to interfere with the peaceful enjoyment of the proprietor, occupier, or other resident of another Lot or of any person lawfully using the common property.

25. Signs

A proprietor, occupier, or other resident of a Lot shall not, except with the written consent of the Strata Company, display or have displayed on his behalf, any sign, advertisement, placard, banner, pamphlet or like matter on any part of his Lot in such a way as to be visible from outside the building, or displayed on any common property.

26. Glass

A proprietor, occupier, or other resident of a Lot shall keep clean all glass in all windows and all doors on the boundary of the Lot.

../3..

BLANK INSTRUMENT FORM

(Note 1)

Notification of Change of By-Laws
Strata Titles Act 1985

The Owners of 98 Mandurah Terrace Mandurah Strata Plan 17133 hereby certify that by a unanimous resolution, duly passed on the 26th November 1995, the By-Laws in Part 1 of Schedule 1 to the Act, as they applied to the building referred to in that Strata Plan, were added to, amended, or repealed as follows:

It is proposed to amend By-Laws 17, 21, 22, 27, 29, and 30, put in place by the Strata Company at the Extraordinary General Meeting on the 17th June, to include the following:

Schedule 1 - Part 1 By-Laws**17. Parking**

- (a) Parking is not permitted in any place, other than the designated marked parking bays.
- (b) Designated "Residents Only" parking areas are for the exclusive use of the proprietors, occupiers, or other residents of Lots 1 to 58 only.
- (c) The parking bays are not to be used for purposes other than the parking of vehicles, unless prior written approval has been given by the Strata Company.

18. Gardens

A proprietor, occupier, or other resident shall not:

- (a) damage any lawn, garden, tree, shrub, plant or flower upon common property, or
- (b) use any portion of the common property for their own purpose as a garden.

19. Clothes Lines

Clothes lines, either temporary or permanent are prohibited in common areas.

20. Animals

Animals are not permitted to be kept in any Lot, or be on any Lot or common property.

21. Hot Water Systems

Electric hot water systems cannot be installed in Lots 1 to 58 after the 23rd January 1993, without the written approval of the Strata Company.

22. Behaviour

A proprietor, occupier, or other resident of a Lot or their guests shall:

- (a) Be adequately clothed upon common property or in the pool area.
- (b) Not use language or behave in a manner likely to cause embarrassment or offence to the proprietor, occupier, or residents of another Lot.

..2..

INSTRUCTIONS

1. This form may be used only when a "Box Type" Form is not provided or is unsuitable. It may be completed in narrative style.
2. If insufficient space hereon Additional Sheet, Form B1, should be used.
3. Additional Sheets shall be numbered consecutively and bound to this document by staples along the left margin prior to execution by the parties.
4. No alteration should be made by erasure. The words rejected should be scored through and those substituted typed or written above them, the alteration being initialled by the persons signing this document and their witnesses.

NOTES

1. Insert document type.
2. A separate attestation is required for every person signing this document. Each signature should be separately witnessed by an Adult person. The address and occupation of the witness must be stated.

G 403460 AE
 21 Feb, 1997 13:29:58 Midland



REG. \$ 60.00

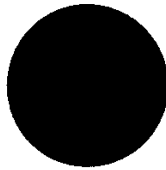

LODGED BY **A.J. MALONE** ^{ADMINISTRATION MANAGER}
 THE OWNERS OF MAJURAH TERRACE
 APARTMENTS (STRATA PLAN 17133)
 ADDRESS **PO BOX 1386**
BUNBURY WA 6231
 PHONE No. **(097) 219 890**
 FAX No. **(097) 219 890**

REFERENCE No.

ISSUING BOX No.

PREPARED BY **A.J. MALONE - TREASURER**
 THE OWNERS OF MAJURAH TERRACE
 APARTMENTS (STRATA PLAN 17133)
 ADDRESS **PO BOX 1386**
BUNBURY WA 6231
 PHONE No. **(097) 219 890** FAX No. **(097) 219 890**

INSTRUCT IF ANY DOCUMENTS ARE TO ISSUE TO OTHER THAN LODGING PARTY.

TITLES, LEASES, DECLARATIONS ETC. LODGED HERewith

- | | |
|----------|-----------------|
| 1. _____ | Received Items |
| 2. _____ | Nos. |
| 3. _____ | |
| 4. _____ | |
| 5. _____ | Receiving Clerk |
| 6. _____ | |

ENDORISING INSTRUCTION

LT14.

EXAMINED

Registered pursuant to the provisions of the TRANSFER OF LAND ACT 1893 as amended on the day and time shown above and particulars entered in the Register Book.

INITIALS OF SIGNING OFFICER



REGISTRAR OF TITLES

BLANK INSTRUMENT FORM

(Note 1)

FORM 21.

NOTIFICATION OF CHANGE OF BY-LAWS.
Strata Titles Act 1985.

Section 42.

The Owners of Mandurah Terrace Apartments Strata Plan No. 17133 hereby certifies that by resolution without dissent, duly passed on the ~~17th November 1996~~, that by-laws in Schedule 1 to the Act as they applied to the strata company, were added to, amended, or repealed as follows -

15 DECEMBER 1996

Assist. Registrar of Titles
19.3.97

It is proposed to amend By-Laws 17 to 36 (inclusive) put in place by the Strata Company at the Annual General Meeting on 26th November 1995, to delete By Law 31: Mail Boxes.

The Common Seal of
The Owners of Mandurah Terrace Apartments
Strata Plan No. 17133
was hereunto affixed
on the 21st day of February 1997
in the presence of:



H J Turner
H.J. TURNER
Councillor

Witness J. Howe

Name JANET ALICE CAROLINE HOWE

Occupation SECRETARY

Address 67 CAMDEN ST DIANELLA

Dated 21-2-97

A. J. Malone
A.J. MALONE
Councillor

Witness C. Malone

Name CHRISTINE RAE MALONE

Occupation SECRETARY

Address UNIT 10/13 UPPER ESPLANADE
BUNBURY

Dated 21/2/97

File Copy Do not Destroy

File Copy Do Not Destroy

Stopped Case **403460**

Stopped Document Disposal Instructions

Original Cs/T:

SP 17133

Fees to be Refunded \$

Notice Sent

Form 10 no.

Action

Date

To

Parties

Document numbers

Computer records adjusted
WDR/MTF/DPA/BKC

Doc's to be rejected

Docs to be withdrawn

Doc's for Registration

Authorised by

Examiner's notes

*Ashley phones re 22 docs
want for objections.*

PH 297 219 890

*I rang & left message
on answering machine*

On 5/3

Examination Instructions

Allocate New C/T

Complete Nom. Index

Pass to

Other

Exam Group 4B

Examiner: L. Ivulich

Supervisor K.Hudson *KLH*



Requisition Notice

Document Nos: G403460
Your Ref: A J Malone
Date: 27.2.97
Lodging Party

Section 192 of the Transfer of Land Act

First and Final

A J Malone

Other Parties Contacted

REGISTRATION OF THE ABOVE DOCUMENTS CANNOT BE EFFECTED UNTIL ALL REQUISITIONS LISTED BELOW ARE COMPLIED WITH AND FEE PAYABLE IS RECEIVED. A TIME LIMIT OF 14 DAYS APPLIES FROM THE DATE STATED ABOVE.

- Unless these items are satisfied, the documents will be rejected and one half the registration fee forfeited
- Documents may be withdrawn from registration for which a fee will be retained. The balance of the fees will be refunded.
- Requisitions must be attended to by personal attendance to the Stopped Documents Section, Midland Square or by correspondence.
- Correspondence by representatives of parties to documents **must state** the capacity in which they act and confirm that they are duly authorised to do so. Amendment by letter is at the discretion of the Registrar of Titles.

Requisitions

Doc.No

The date of the "Resolution" has expired. The strata scheme has not later than 3 months after passing of the resolution to lodge the amendment.

Req. Fee

/

Requisition Sub Total \$
Additional Fee \$
TOTAL FEE Payable \$

/

F L P Calginari
Assistant Registrar of Titles

Land Titles Division

ALL Enquiries to the STOPPED DOCUMENTS Section, Midland Square, Midland

Telephone (09) 273 7337 Fax (09) 273 7658, Postal Address: P O Box 2222, Midland, Western Australia 6056: DX88
Cheques or money orders to be made payable to the Registrar of Titles.

Mandurah Terrace Apartments

The Owners of
MANDURAH TERRACE APARTMENTS
Strata Plan 17133
PO Box 1386
BUNBURY WA 6231

Phone/Fax (097) 219 890

4 March 1997

Dept of LAND ADMINISTRATION
(Attn: Stopped Documents Section)
PO Box 2222
MIDLAND WA 6056

Facsimile (09) 273 7658

Dear Sir/Madam,

RE: Document G403460 MANDURAH TERRACE APARTMENTS.

I phoned your office, last Friday 28/7/97, to discuss the Requisition Notice you faxed me last Thursday, and I was told someone from your Section would contact me this week. I haven't heard from anyone, as yet, so I thought I would give you written advice of the clarification I require.

The Resolution which you claim has "expired" was a Resolution Without Dissent first tabled at our Strata Company's Annual General Meeting on November 17th 1996. According to Section 3A of the Strata Titles Act such a Resolution, if all Lot Owners are not in attendance to signify their vote on that day, any objection has to be lodged with the Strata Company within "28 days after the day of the meeting". I therefore contend that a Resolution Without Dissent cannot be considered to have been "passed", until the expiration of that post-meeting notice period. Any 3 month sunset clause (if it exists) would have to apply to that date (December 15th) not the date of the AGM where it was put to the vote.

Secondly, reading through Section 3A again, I have not been able to find any conditions for a "resolution without dissent" that impose a 3 month limitation in lodging the Change of By-Law agreed to by ALL the Lot Owners under Strata Plan 17133.

I await your careful consideration of the points I've put forward, so the Strata Company can deal with the matter quickly.

Thank you for your attention

Yours sincerely,

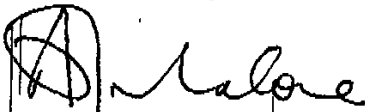

A.J. MALONE (Treasurer & Administration Manager)

Mandurah Terrace Apartments

The Owners of
MANDURAH TERRACE APARTMENTS
Strata Plan 17133
PO Box 1386
BUNBURY WA 6231

Phone/Fax (097) 219 890

5 March 1997

Dept of LAND ADMINISTRATION
Stopped Documents Section
(Attention Alex Madden)
PO Box 2222
MIDLAND WA 6056

Facsimile (09) 273 7658

Dear Sir,

RE: Document G403460 YOUR PHONE CALL ON 5/3/97.

I apologise if your name is spelt incorrectly. It's difficult to work out from a phone message.

Nevertheless, thank you for your call today, and, the reference to Section 42 sub-section 4 to qualify the 3 month limitation on lodging the repeal of a By-Law. However, it doesn't clear up my original question in relation to the Requisition Notice I've received. Just in case you haven't seen the facsimile sent to you yesterday, let me take you through it.

The Resolution which you claim has "expired" was a Resolution Without Dissent first tabled at our Strata Company's Annual General Meeting on November 17th 1996. According to Section 3A of the Strata Titles Act such a Resolution, if all Lot Owners are not in attendance to signify their vote on that day, any objection has to be lodged with the Strata Company within "28 days after the day of the meeting". I therefore contend that a Resolution Without Dissent cannot be considered to have been "passed", until the expiration of that post-meeting notice period. Any 3 month sunset clause would have to apply to that date (December 15th) not the date of the A.G.M. where it was put to the vote. SECTION 42 Sub-Section 4 refers only to "the passing of the resolution" and doesn't refer specifically to any Meeting.

I await your careful consideration of the point I've put forward, so the Strata Company can deal with the matter quickly.

Thank you for your attention

Yours sincerely,

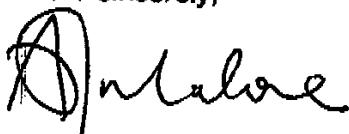

A.J. MALONE (Treasurer & Administration Manager)

MEMO TO

Manages Legal.

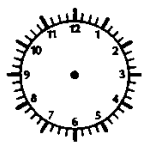

SUBJECT *Sec A2 Strata Title..*

DATE *10.3.97* REFERENCE NUMBER *G403460*

Please read the submission presented and if necessary seek direction from a legal officer and supply same to me.

REPLY/ACTION WANTED:

- TODAY
- TOMORROW
- NOT URGENT
- PLEASE TELEPHONE

- REPLY:
- YOUR COMMENT NOTED
 - MATTER ATTENDED TO

FROM

Alex Madden

OLYMPIC A4 MEMO PAD No. 23730

Mandurah Terrace Apartments

The Owners of
MANDURAH TERRACE APARTMENTS
Strata Plan 17133
PO Box 1386
BUNBURY WA 6231

Phone/Fax (097) 219 890

13 March 1997

Dept of LAND ADMINISTRATION
Stopped Documents Section
PO Box 2222
MIDLAND WA 6056

LEGOC

Facsimile (09) 273 7658

Dear Sir/Madam,

RE: Your Lack of a Reply to an enquiry re Document G403460.

I still haven't heard from anyone in your section, in relation to the facsimile I sent to Alex Madden on march 4th, raising an important question that needs to be dealt with.

Your office has prevented the repeal of a By-Law on Strata Plan 17133, because you say the Lodgement was outside the time allowed. However, my previous correspondence explained why I believe it WASN'T OUTSIDE THE TIME FRAME.

Would you please do me the courtesy of reading the following explanation, and providing an official response. By the way, it's very frustrating to be ignored, so I would hope there's some reason why you haven't replied to (or even acknowledged) the 4th of March facsimile.

The Resolution which you claim has "expired" was a Resolution Without Dissent first tabled at our Strata Company's Annual General Meeting on November 17th 1996. According to Section 3A of the Strata Titles Act such a Resolution, if all Lot Owners are not in attendance to signify their vote on that day, any objection has to be lodged with the Strata Company within "28 days after the day of the meeting". I therefore contend that a Resolution Without Dissent cannot be considered to have been "passed", until the expiration of that post-meeting notice period. Any 3 month sunset clause would have to apply to that date (December 15th) not the date of the A.G.M. where it was put to the vote. SECTION 42 Sub-Section 4 refers only to "the passing of the resolution" and doesn't refer specifically to any Meeting.

I await your careful consideration of the point I've put forward, so the Strata Company can deal with the matter quickly.

Yours sincerely,



A.J. MALONE (Treasurer & Administration Manager)

LEGOC

Our Ref :G403460:JF

Mandurah Terrace Apartments
PO Box 1386
Bunbury WA 6231

Dear Mr Malone

RE: AMENDMENT OF BY- LAWS G403460

Thank you for your letter dated 4th and 13th March 1997 explaining the situation regarding the date of passing a Resolution Without Dissent pursuant to the Strata Titles Act as amended. I apologise for the delay in responding to your initial submission.

Your submissions correctly state the legal position that a Resolution Without Dissent is not passed, unless all proprietors attend the meeting of the Strata Company, until 28 days notice period has elapsed. In this is the case the 15 December 1996 was the date the resolution was passed. Therefore 15 December 1996 should have been stated in G403460, not the date on which the meeting was held. A letter requesting the Registrar of Titles to show the correct date in G403460 will rectify the requisition.

I trust that the above explanation will assist you in this matter.

Your faithfully



FRED CALGINARI
Assistant Registrar of Titles

17 March 1997

MESSAGE CONFIRMATION

17/03/97 08:26
ID=DOLA LAND TITLES LEGAL SECTIC

DATE	TIME	S,R-TIME	DISTANT STATION ID	MODE	PAGES	RESULT
17/03	08:24	01'22"	097219890	G3-S	01	OK 0000

Mandurah Terrace Apartments

The Owners of
MANDURAH TERRACE APARTMENTS
Strata Plan 17133
PO Box 1386
BUNBURY WA 6231

Phone/Fax (097) 219 890

18 March 1997

Dept of LAND ADMINISTRATION
(Attn Registrar of Titles)
PO Box 2222
MIDLAND WA 6056

Facsimile (09) 273 7658

LEG001

Dear Sir/Madam,

RE: Document G403460.

Following correspondence from the Stopped Documents Sections, I been requested to write to you confirm that the date shown on the Resolution without Dissent has wrongly been stated as November 17th 1996.

The Resolution wasn't passed until December 15th 1996.

Would you kindly alter the Document to show the correct date, so it can then be processed and added to our Strata Plan. In other words, the Amendment should now read:

The Owners of Mandurah Terrace Apartments Strata Plan No. 17133 hereby certifies that by resolution without dissent, duly passed on the **15th December 1996**, that by-laws in Schedule 1 to the Act as they applied to the strata company, were added to, amended, or repealed as follows -

It is proposed to amend By-Laws 17 to 36 (inclusive) put in place by the Strata Company at the Annual General Meeting on 26th November 1995, to delete By Law 31: Mail Boxes.

Thank you for your attention to this request.

Yours sincerely,

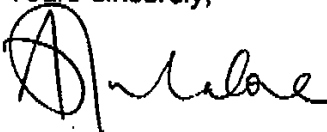

A.J. MALONE (Treasurer & Administration Manager)

INSTRUCTIONS

1. This form may be used only when a "Box Type" form is not provided or is unsuitable. It may be completed in narrative style.
2. If insufficient space hereon Additional Sheet Form B1 should be used.
3. Additional Sheets shall be numbered consecutively and bound to this document by staples along the left margin prior to execution by the parties.
4. No alteration should be made by erasure. The words rejected should be scored through and those substituted typed or written above them, the alteration being initialled by the persons signing this document and their witnesses.

NOTES

1. Insert document type.
2. A separate attestation is required for every person signing this document. Each signature should be separately witnessed by an Adult Person. The address and occupation of the witness must be stated.

OFFICE USE ONLY

G 703970 AE

04 Feb, 1998 08:49:15 Bunbury



REG. \$ 60.00

ADMINISTRATION MANAGER

LODGED BY **STRATA PLAN 17133**
 ADDRESS **P.O. BOX 1386**
BUNBURY W.A. 6231

PHONE No. **(08) 9721 9890**

FAX No. **(08) 9721 9890**

REFERENCE No.

ISSUING BOX No. **999**

PREPARED BY **A. J. MALONE - TREASURER**

THE OWNERS OF MANDURAH

TERRACE APARTMENTS

ADDRESS **STRATA PLAN 17133**

P.O. BOX 1386

BUNBURY WA 6231

PHONE No. **(08) 9721 9890** FAX No. **(08) 9721 9890**

INSTRUCT IF ANY DOCUMENTS ARE TO ISSUE TO OTHER THAN LODGING PARTY

TITLES, LEASES, DECLARATIONS ETC LODGED HEREWITH

1.	_____	Received Items
2.	_____	Nos. -
3.	_____	
4.	_____	
5.	_____	
6.	_____	Receiving Clerk CF.

Registered pursuant to the provisions of the TRANSFER OF LAND ACT 1893 as amended on the day and time shown above and particulars entered in the Register.

EXAMINED

Amended By [Signature]

[Signature]

pled



36. Breaches of By-Laws

Any costs incurred from a breach of the By-Laws by a proprietor, occupier, other resident, or their guests is to be paid for by the proprietor of the Lot who committed the breach or whose occupier, other resident, or guest committed the breach. Breaches of this nature can be, but are not limited to the following:

- Security call out
- Clean up of rubbish
- Repair of damage to common property
- Towing costs of vehicles

The Common Seal of The Owners of Mandurah Terrace Apartments Strata Plan No. 17133 was hereunto affixed on the 31st day of January 1998 in the presence of:

C.G.F. Pearce
 C.G.F. PEARCE
 Councillor

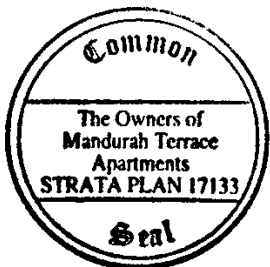

A.J. Malone
 A.J. MALONE
 Councillor

Witness [Signature]

Name DION FLETCHER

Occupation PENSIONER

Address PO Box 320 MANDURAH

Dated 1-2-98

Witness [Signature]

Name CHRISTINE RAE MALONE

Occupation EXECUTIVE SECRETARY

Address UNIT 10/13 UPPER ESPLANADE
BUNBURY WA 6230

Dated 31/1/98

31. Smoke Alarms.

All proprietors of Lots 1 to 58 are required to maintain at least one Smoke Alarm in each Lot, in good working order at all times.

32. Building Maintenance

- (a) Lots 1 to 58 external building maintenance is arranged by the Strata Company. In normal circumstances this maintenance will be paid for by the Strata Company, but in exceptional circumstances a levy may be required to meet the costs.
- (b) Lots 59 to 62 internal and external building maintenance is arranged by and paid for by the proprietors of those Lots.
- (c) The Strata Company reserves the right of approval for all external refurbishment of Lots 1 to 62.

33. Common Area Maintenance

- (a) Driveways and all rear common areas are maintained by the Strata Company. In normal circumstances this maintenance will be paid for by the Strata Company, but in exceptional circumstances a levy may be required to meet the costs.
- (b) The proprietor of Lots 59 & 60 is responsible for the maintenance and associated costs in respect to the common area at the front of those Lots.
- (c) The proprietor of Lots 61 & 62 is responsible for the maintenance and associated costs in respect to the common areas at the front of and beside those Lots.

34. Common Facilities Fee.

A Common Facilities Fee, to recover the cost of Gas and Water consumed by the Residents of Lots 1 to 58, is charged monthly at a rate determined annually by the Strata Company .

35. Levies

- (a) Lots (Units) 1 to 58 pay a quarterly levy to the Strata Company. This levy is determined each year during budget preparation.
- (b) Lots (Units) 59 & 62 do not pay levies to the Strata Company but are responsible for the following-
- All power charges associated with their Lots including common area lighting.
 - All building maintenance costs both internal and external for their Lots.
 - All common area garden and ground maintenance at the front of and beside their Lots.
 - All common area lighting maintenance at the front of and at the side of their Lots.
 - Arrangement of their garbage collections.

..5/..

ADDITIONAL PAGE TO

Dated 31ST JANUARY 1998

- 3 -

27. Electricity.

- (a) Lots 1 to 58 are charged at a rate of 2 cents higher than the applicable Western Power rate, to cover the cost of administration and collection of payments for electricity consumed in each Lot, and
- (b) The balance of the surcharge is used, to cover a portion of the cost of electricity consumed in all Common Areas.
- (c) The Strata Company is not responsible for paying the cost of Electricity consumed on Lots 59 - 62, which have separate Western Power metering.
- (d) Power consumption costs for the Pool Area are paid for by the Strata Company, provided the proprietors of Lots 1 - 58 have responsibility for maintenance, security, and use of the Pool facilities.

28. Hot Water Supply

The gas fired boiler supplying hot water to Lots 1 to 60 is located in Lot 59 and owned by that proprietor.

A charge which is reviewed annually is met by the Strata Company and paid to the proprietor of Lot 59 to cover all running (excluding gas) and maintenance costs associated with the boiler and circulating pumps.

29. Gas.

- (a) The Strata Company is responsible for the hire of the LPG gas storage tank, which supplies gas to the hot water boiler and Lot 59.
- (b) The cost of Gas consumed in Lots 1 to 58 is recovered through the Common Facilities Fee.
- (c) The cost of annual maintenance of the storage facility is shared by the proprietors of Lots 1 to 58, and the proprietor of Lots 59 & 60 based, on the relative proportion of Gas consumed by the parties to the agreement.
- (d) This By-Law precludes Lots with electric hot water systems.

30. Water.

- (a) Lots 1 to 60 are supplied via a common meter, and the apportionment of costs are determined annually by the Strata Company and the proprietor of Lots 59 & 60.
- (b) Lots 61 & 62 are supplied via their own meter, and are responsible for their own consumption costs.
- (c) The cost of Water consumed in Lots 1 to 58 is recovered through the Common Facilities Fee.

..4/..

22. Behaviour

A proprietor, occupier, or other resident of a Lot or their guests shall:

- (a) Be adequately clothed upon common property or in the pool area.
- (b) Not use language or behave in a manner likely to cause embarrassment or offence to the proprietor, occupier, or residents of another Lot.
- (c) Not cause any noise which disturbs other residents.
- (d) Not damage or mistreat any Common Property, Pool Area Furniture, Pool Equipment, Pool Structure, or general Building Structure.
- (e) Comply with the following Pool Rules:
 - Open 8am to 8pm only.
 - For the use of residents and owners only.
 - Keep your children under supervision at all times while they are using the pool.
 - Do not bring glass into the pool enclosure.
 - Consider safety by not running in the pool area.
 - No "bommies" or dangerous diving.
 - Sauna users must shower before using the pool.
- (f) Not store, hang, or leave any property, clothes, or personal effects on the common area.

23. Children

A proprietor, occupier, or other resident of a Lot or their guests shall not permit any child of whom he/she has control to play upon common property within the building or, unless accompanied by an adult exercising effective control, to be or to remain upon common property comprising a laundry, car parking area or other area of possible danger or hazard to children.

24. Rubbish

A proprietor, occupier, or other resident of a Lot or their guests shall not deposit or throw upon the common property any rubbish, dirt, dust, or other material likely to interfere with the peaceful enjoyment of the proprietor, occupier, or other resident of another Lot or of any person lawfully using the common property.

25. Signs

A proprietor, occupier, or other resident of a Lot shall not, except with the written consent of the Strata Company, display or have displayed on his behalf, any sign, advertisement, placard, banner, pamphlet or like matter on any part of his Lot in such a way as to be visible from outside the building, or displayed on any common property.

26. Glass

A proprietor, occupier, or other resident of a Lot shall keep clean all glass in all windows and all doors on the boundary of the Lot.

..3/..

BLANK INSTRUMENT FORM

┌ ┌ (Note 1)

└ └

┌ FORM 21. └

NOTIFICATION OF CHANGE OF BY-LAWS.
Strata Titles Act 1985.

Section 42.

The Owners of Mandurah Terrace Apartments Strata Plan No. 17133 hereby certifies that by resolution without dissent, duly passed at a meeting of the Strata Company on the 23rd of November 1997 which became unconditional on the 21st of December 1997, the by-laws in Schedule 1 to the Act as they applied to the strata company, were added to, amended, or repealed as follows -

It is proposed to amend By-Laws 17 to 36 (inclusive):

17. Parking

- (a) Parking is not permitted in any place, other than the designated marked parking bays.
- (b) Designated "Residents Only" parking areas are for the exclusive use of the proprietors, occupiers, or other residents of Lots 1 to 58 only.
- (c) The parking bays are not to be used for purposes other than the parking of vehicles, unless prior written approval has been given by the Strata Company.

18. Gardens

A proprietor, occupier, or other resident shall not:

- (a) damage any lawn, garden, tree, shrub, plant or flower upon common property, or
- (b) use any portion of the common property for their own purpose as a garden.

19. Clothes Lines

Clothes lines, either temporary or permanent are prohibited in common areas.

20. Animals

Animals are not permitted to be kept in any Lot, or be on any Lot or common property.

21. Hot Water Systems

Electric hot water systems cannot be installed in Lots 1 to 58 after the 23rd January 1993, without the written approval of the Strata Company.

..2/..

┌ └

INSTRUCTIONS

1. This form may be used only when a "Box Type" form is not provided or is unsuitable. It may be completed in narrative style.
2. If insufficient space hereon Additional Sheet Form B1 should be used.
3. Additional Sheets shall be numbered consecutively and bound to this document by staples along the left margin prior to execution by the parties.
4. No alteration should be made by erasure. The words rejected should be scored through and those substituted typed or written above them, the alteration being initialled by the persons signing this document and their witnesses.

NOTES

1. Insert document type.
2. A separate attestation is required for every person signing this document. Each signature should be separately witnessed by an Adult Person. The address and occupation of the witness must be stated.

J 198660 AE

24 Feb, 2005 15:38:49 Perth



REG. \$ 79.00

LODGED BY **ATKINSON ASSOCIATES**
 ADDRESS **Level 1, 216 St George's**
Perth WA 6000
 PHONE No. **9321 0555**
 FAX No. **9321 0566**
 REFERENCE No. **MA: 4625**
 ISSUING BOX No. **888**

PREPARED BY **Ian Laird**

P O Box 139
Fremantle 6959

PHONE No. **9430 4468** FAX No. **9430 9951**

INSTRUCT IF ANY DOCUMENTS ARE TO ISSUE TO OTHER THAN LODGING PARTY

TITLES, LEASES, DECLARATIONS ETC LODGED HEREWITH

1.	_____	Received Items
2.	_____	Nos.
3.	_____	
4.	_____	
5.	_____	
6.	_____	Receiving Clerk

Registered pursuant to the provisions of the TRANSFER OF LAND ACT 1893 as amended on the day and time shown above and particulars entered in the Register.

EXAMINED

check below
B
3



MUTUAL RESIDENTIAL COST RESPONSIBILITY

(AS PER SURVEY)

Perimeter of Parcel

Mutual Residential Cost Responsibility Area

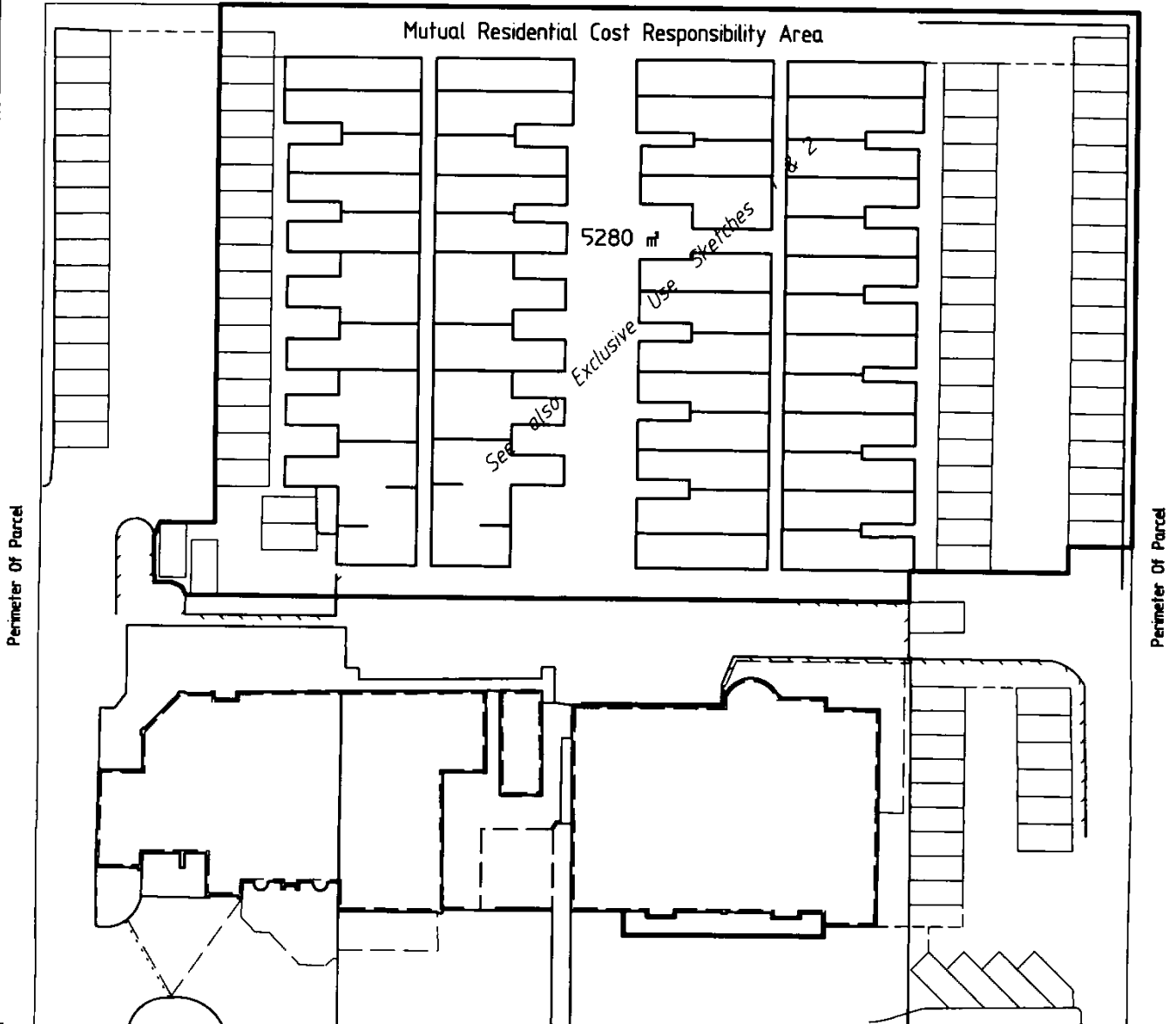

Perimeter of Parcel

MANDURAH TERRACE

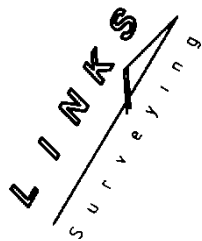

LINKS
 Surveying
 LAND DEVELOPMENT CONSULTANTS
 P.O. Box 118, WILLETTON, 6955
 Telephone (08) 9354 8511
 Facsimile (08) 9354 8522
 Email links @ links-surveying.com.au

STRATA COMPANY

THE OWNERS OF MANDURAH TERRACE APARTMENTS STRATA PLAN 17133

LOCATION PLAN

For Sketches 1 to 7 inclusive.
 Areas for assignment of care.

**EXCLUSIVE USE OF COMMON PROPERTY,
 BUILDING, OTHER IMPROVEMENTS
 and COMMON PROPERTY PARKING.**

27

REF LAIRD

DATE 10.05.04

SCALE 1 : 600

JOB No. 11771/005/DWG77104

LINKS Surveying
P.O. Box 118
WILLETTON 6955

Tel: 9354 8511
Fax: 9354 8522

E-mail: links @ links-surveying.com.au

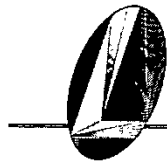

LINKS

Surveying

Land Development Consultants and Licensed Surveyors

My Ref.: 11771 / 004
Your Ref.: Laird

24th April 2004

Strata Company The Owners of Mandurah Terrace Apartments – Strata Plan 17133.

EXCLUSIVE USE SKETCH 7

GROUND and FIRST FLOOR – LOT 62.

Sheet 2 of 2 Sheets.

EXCLUSIVE USE OF BUILDING, COMMON PROPERTY AIR SPACE and OTHER IMPROVEMENTS

Excluding the Perimeter of the Parcel, the angles are multiples of 45 degrees unless stated otherwise.

BOUNDARY DESCRIPTIONS

The boundaries of the exclusive use areas marked 'B62' which are buildings are from the upper surface of the floor and extend to the external surface of the building from the inner surfaces of the walls but limited in height to the projection of 1.0 metre above the existing upper roof surface of Lot 62.

The boundaries of the exclusive use area marked 'GEX62A' are from the under surface of the concrete slab to the projection of height of the Lot 62 floor surface or where covered to the underside of that cover.

The boundaries of the exclusive use area marked 'GEX62B' are from under surface of the ground floor slab of Lot 61 to the projection of the underside of balcony structure.

Maintaining Traditional Standards Through People and Technology
STANDFAST NOMINEES Pty Ltd trading as LINKS Surveying. A.B.N. 55 059 735 536

26

See Sheet 2 of 2 sheets
for Boundary Descriptions.

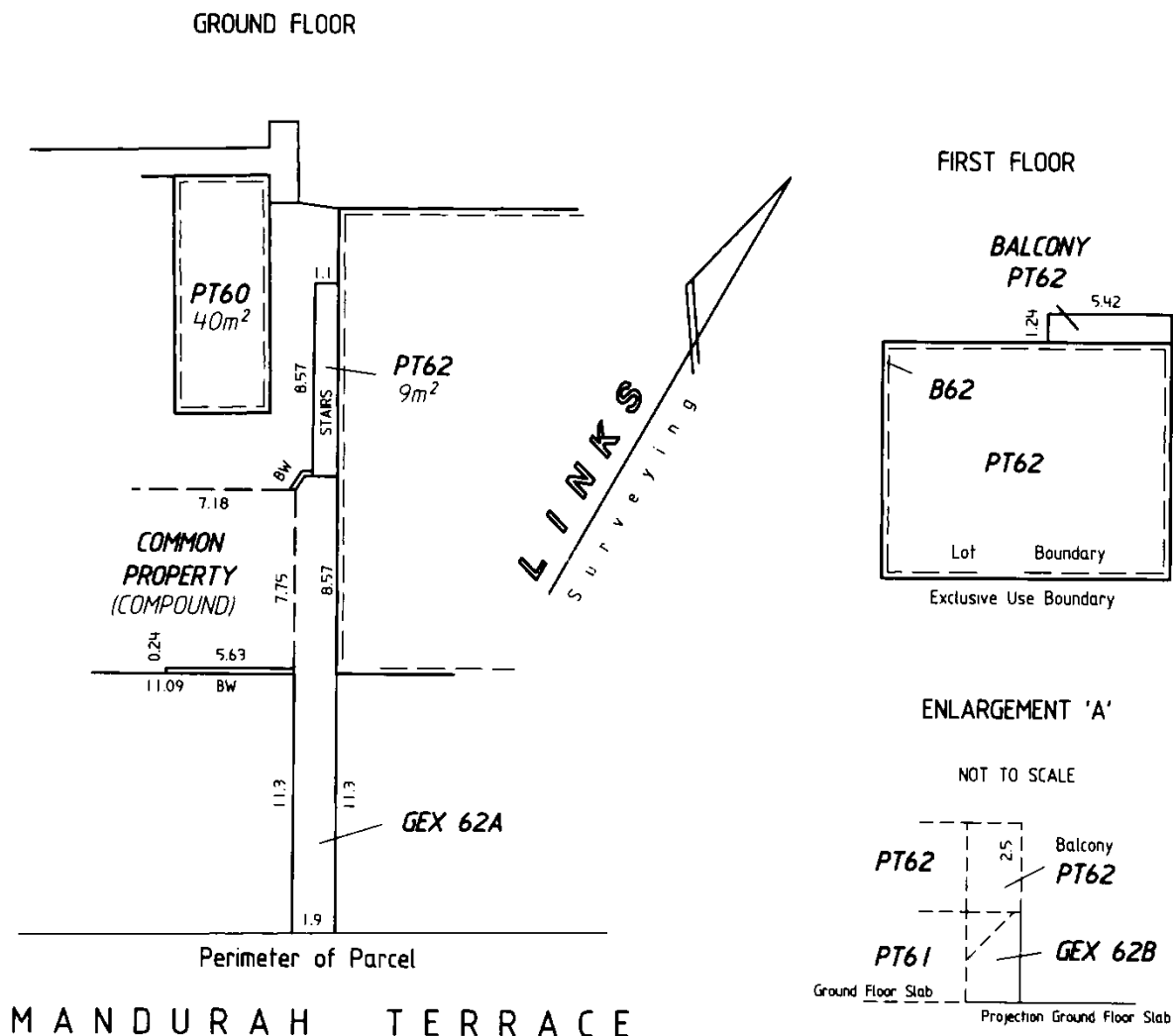

KEY

- P T - PART LOT
- E X - EXCLUSIVE USE
- B W - BRICK WALL
- B - BUILDING

NUMBERS INDICATE THE NUMBER OF THE LOT TO WHICH IS ASSIGNED THE EXCLUSIVE USE.

LINKS
Surveying

LAND DEVELOPMENT CONSULTANTS
P.O. Box 118, WILLETTON, 6955
Telephone (08) 9354 8511
Facsimile (08) 9354 8522
Email links @ links-surveying.com.au

STRATA COMPANY

THE OWNERS OF MANDURAH TERRACE APARTMENTS STRATA PLAN 17133

GROUND and FIRST FLOOR

LOT 62.

EXCLUSIVE USE OF BUILDING, COMMON PROPERTY AIR SPACE and OTHER IMPROVEMENTS.

25

REF LAIRD

DATE 04.04.04

SCALE 1:300

JOB No. 11771/004/DWG77104

LINKS Surveying
P.O. Box 118
WILLETTON 6955

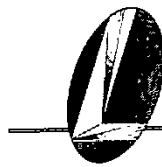

LINKS

Surveying

Land Development Consultants and Licensed Surveyors

Tel: 9354 8511
Fax: 9354 8522

E-mail: links @ links-surveying.com.au

My Ref.: 11771 / 005
Your Ref. : Laird

24th April 2004

Strata Company The Owners of Mandurah Terrace Apartments – Strata Plan 17133.

EXCLUSIVE USE SKETCH 6

GROUND FLOOR – LOT 61.

Sheet 2 of 2 Sheets.

**EXCLUSIVE USE OF BUILDING and OTHER IMPROVEMENTS
and COMMON PROPERTY PARKING.**

Excluding the Perimeter of the Parcel, the angles are multiples of 45 degrees unless stated otherwise.

BOUNDARY DESCRIPTIONS

The boundaries of the exclusive use areas marked 'B61' which are buildings are from the under surface of the ground floor concrete slab and extend to the external surface of the building from the inner surfaces of the walls but limited in height to the projection of 1.0 metre above the existing upper roof surface of Lot 61 except where covered by Lot 62 and its adjacent building surface where the height is limited to the upper surface of the floor of Lot 62.

The boundaries of the exclusive use areas marked 'GEX61' are from the lowest foundation of the adjacent retaining wall to a height equal to the projection of the top of the fence situated on the part Lot 61 north west boundary.

The boundaries of the exclusive use area marked 'GEX61A' are from 2 metres below the surface of the brick paving to the projection of 1.0 metre above the existing upper roof surface of Lot 61 or where covered to the underside of that cover.

The boundaries of the exclusive use area marked 'GEX61B' are from the under surface of the concrete slab to the projection of 1.0 metre above the existing upper roof surface of Lot 61 including where covered.

Maintaining Traditional Standards Through People and Technology
STANDFAST NOMINEES Pty Ltd trading as LINKS Surveying. A.B.N. 55 059 735 536

24

EXCLUSIVE USE SKETCH 6

(AS PER SURVEY)

SHEET 1 OF 2 SHEETS

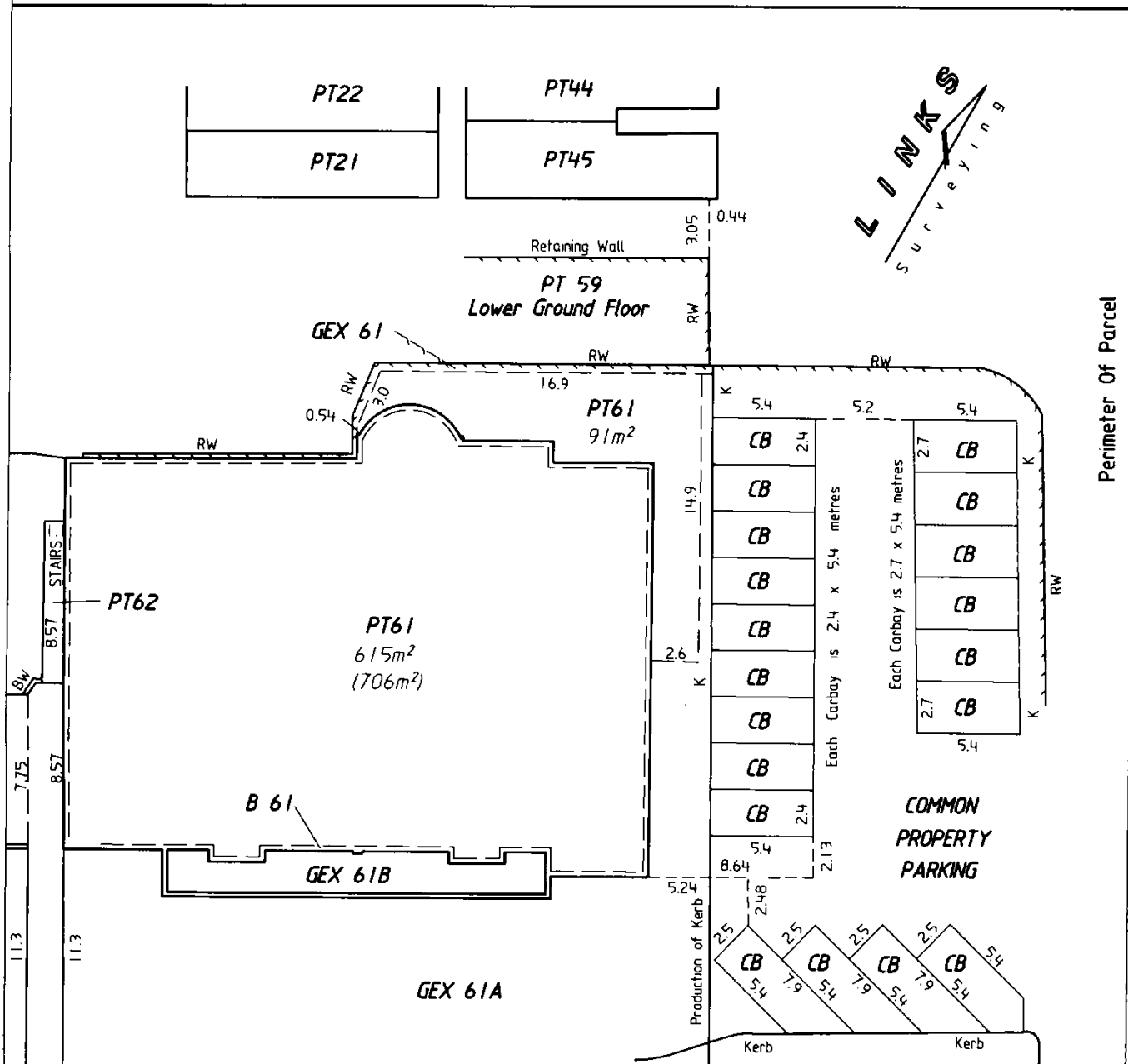
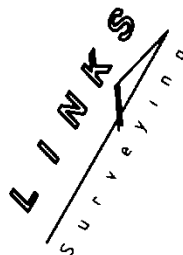

Perimeter Of Parcel

Perimeter of Parcel

See Sheet 2 of 2 sheets for Boundary Descriptions.

MANDURAH TERRACE

KEY

- P T - PART LOT
- C B - CARBAY
- K - CONCRETE KERB
- E X - EXCLUSIVE USE
- B W - BRICK WALL
- R W - RETAINING WALL
- B - BUILDING

NUMBERS INDICATE THE NUMBER OF THE LOT TO WHICH IS ASSIGNED THE EXCLUSIVE USE.

LINKS

Surveying
 LAND DEVELOPMENT CONSULTANTS
 P.O. Box 118, WILLETTON, 6955
 Telephone (08) 9354 8511
 Facsimile (08) 9354 8522
 Email links@links-surveying.com.au

STRATA COMPANY

THE OWNERS OF MANDURAH TERRACE APARTMENTS STRATA PLAN 17133

GROUND FLOOR

LOT 61.

EXCLUSIVE USE OF BUILDING and OTHER 23
 IMPROVEMENTS and COMMON PROPERTY PARKING.

REF LAIRD

DATE 23.04.04

SCALE 1 300

JOB No. 11771/005/DWG77104



LINKS Surveying
P.O. Box 118
WILLETTON 6955

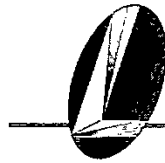

LINKS

Surveying

Land Development Consultants and Licensed Surveyors

Tel: 9354 8511
Fax: 9354 8522

E-mail: links @ links-surveying.com.au

My Ref.: 11771 / 004
Your Ref.: Laird

24th April 2004

Strata Company The Owners of Mandurah Terrace Apartments – Strata Plan 17133.

EXCLUSIVE USE SKETCH 5

GROUND FLOOR – LOT 60.

Sheet 2 of 2 Sheets.

EXCLUSIVE USE OF BUILDING and OTHER IMPROVEMENTS

Excluding the Perimeter of the Parcel, the angles are multiples of 45 degrees unless stated otherwise.

BOUNDARY DESCRIPTIONS

The boundaries of the exclusive use areas marked 'B60' which are buildings are from the under surface of the ground floor concrete slab and extend to the external surface of the building from the inner surfaces of the walls but limited in height to the projection of 0.8 metres above the existing upper southern façade surface of Lot 60.

The boundaries of the exclusive use area marked 'GEX60A' are from 2 metres below the surface of the brick paving to the projection 0.8 metres above the existing upper southern façade surface of Lot 60 or where covered to the underside of that cover.

The boundaries of the exclusive use area marked 'GEX60B' are from the under surface of the ground floor concrete slab to the projection of 0.8 metres above the existing upper southern façade surface of Lot 60 including where covered.

Maintaining Traditional Standards Through People and Technology
STANFAST NOMINEES Pty Ltd trading as LINKS Surveying. A.B.N. 55 059 735 536

22

EXCLUSIVE USE SKETCH 5

(AS PER SURVEY)

SHEET 1 OF 2 SHEETS

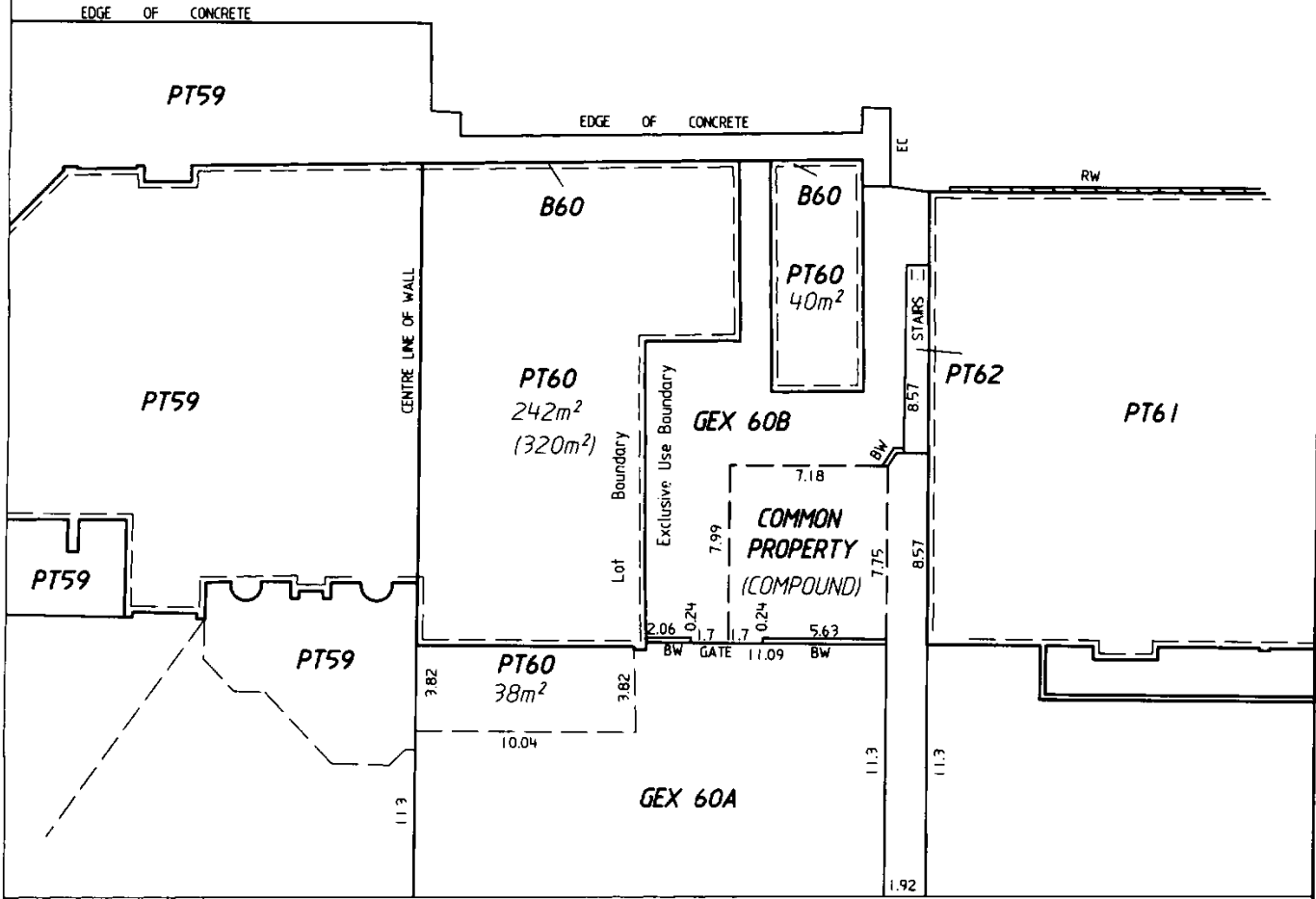

Perimeter of Parcel

MANDURAH TERRACE

See Sheet 2 of 2 sheets for Boundary Descriptions.

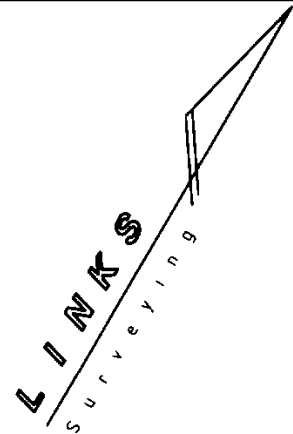

KEY

- P T - PART LOT
- G A - GARDEN AREA
- E C - EDGE OF CONCRETE
- E X - EXCLUSIVE USE
- B W - BRICK WALL
- R W - RETAINING WALL
- B - BUILDING

NUMBERS INDICATE THE NUMBER OF THE LOT TO WHICH IS ASSIGNED THE EXCLUSIVE USE.

LINKS

Surveying
 LAND DEVELOPMENT CONSULTANTS
 P.O. Box 118, WILLETTON, 6955
 Telephone (08) 9354 8511
 Facsimile (08) 9354 8522
 Email links @ links-surveying.com.au

STRATA COMPANY

THE OWNERS OF MANDURAH TERRACE APARTMENTS STRATA PLAN 17133

GROUND FLOOR

LOT 60.

EXCLUSIVE USE OF BUILDING and OTHER IMPROVEMENTS.

21

REF LAIRD

DATE 04.04.04

SCALE 1 300

JOB No. 11771/004/DWG77104

LINKS Surveying
P.O. Box 118
WILLETTON 6955

Tel: 9354 8511
Fax: 9354 8522

E-mail: links @ links-surveying.com.au

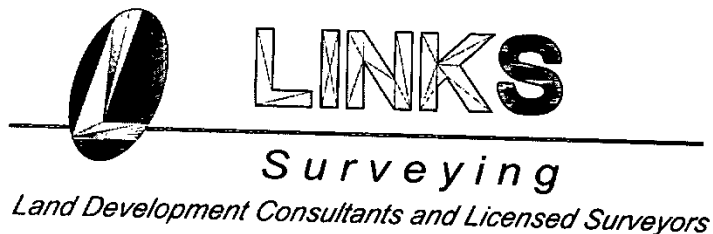

My Ref.: 11771 / 004
Your Ref. : Laird

24th April 2004

Strata Company The Owners of Mandurah Terrace Apartments – Strata Plan 17133.

EXCLUSIVE USE SKETCH 4

GROUND FLOOR – LOT 59.

Sheet 2 of 2 Sheets.

EXCLUSIVE USE OF BUILDING and OTHER IMPROVEMENTS

Excluding the Perimeter of the Parcel, the angles are multiples of 45 degrees unless stated otherwise.

BOUNDARY DESCRIPTIONS

The boundaries of the exclusive use areas, marked 'B59' which are buildings are from the under surface of the ground floor concrete slab and extend to the external surface of the building from the inner surfaces of the walls but limited in height to the projection of 0.8 metres above the existing upper southern façade surface of Lot 59.

The boundaries of the exclusive use areas marked 'PC59' which is a "Porte Cochere" are from the under surface of its ceiling to the projection of 0.8 metres above the existing upper southern façade surface of Lot 59.

The boundaries of the exclusive use areas marked 'GA59' which are gardens are from 2 metres below the surface of the adjacent brick paving to the projection 0.8 metres above the existing upper southern façade surface of Lot 59.

The boundaries of the exclusive use area marked 'GEX59' are from 2 metres below the surface of the brick paving to the projection of 0.8 metres above the existing upper southern façade surface of Lot 59 or where covered to the underside of that cover.

Maintaining Traditional Standards Through People and Technology
STANDFAST NOMINEES Pty Ltd trading as LINKS Surveying. A.B.N. 55 059 735 536

20

EXCLUSIVE USE SKETCH 4
(AS PER SURVEY)

SHEET 1 OF 2 SHEETS

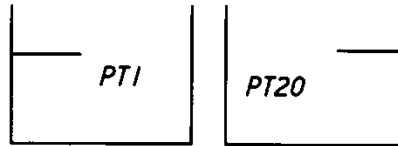

Perimeter Of Parcel

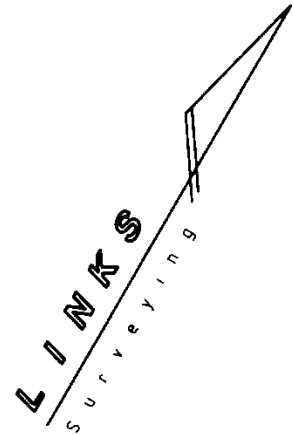
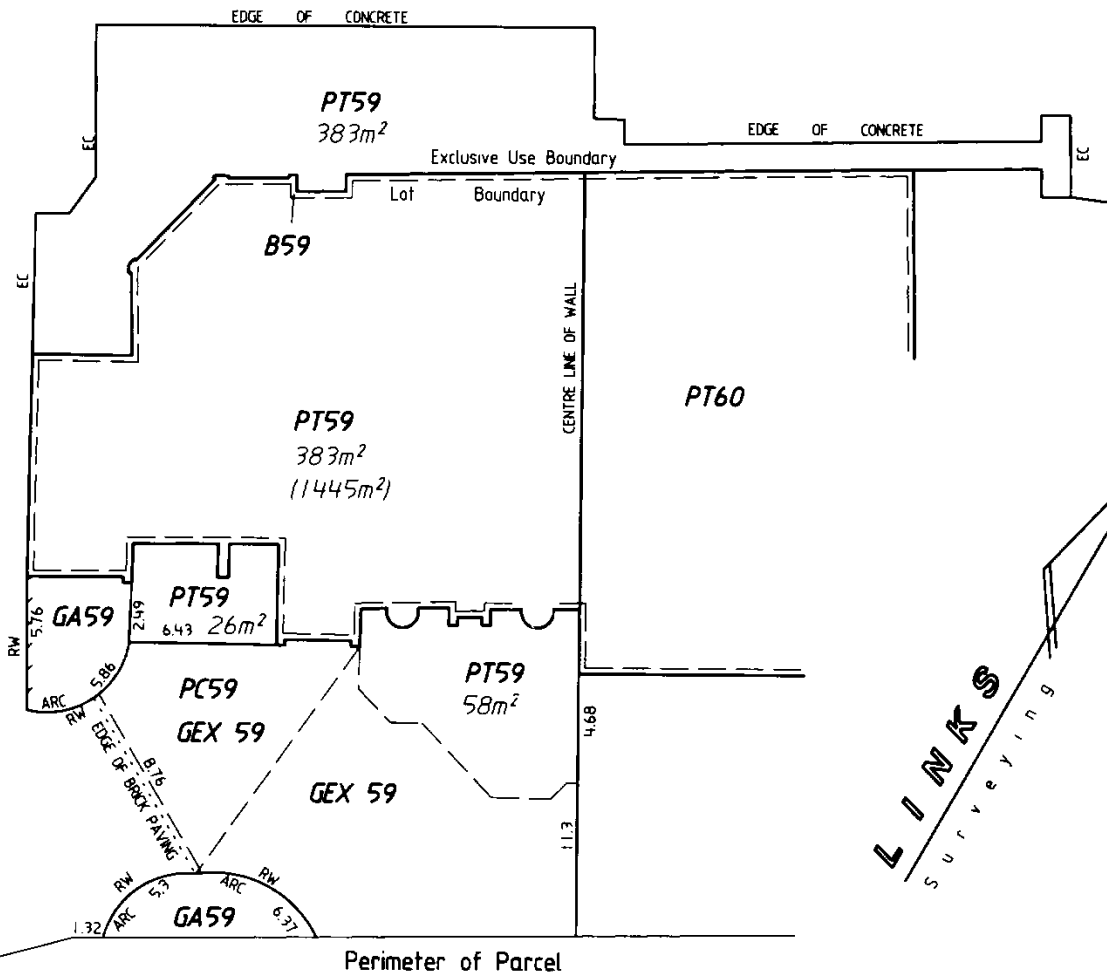

See Sheet 2 of 2 sheets
for Boundary Descriptions.

MANDURAH TERRACE

KEY

- P T - PART LOT
- G A - GARDEN AREA
- E C - EDGE OF CONCRETE
- E X - EXCLUSIVE USE
- P C - PORTE COCHERE
- R W - RETAINING WALL
- B - BUILDING

NUMBERS INDICATE THE NUMBER OF THE LOT TO WHICH IS ASSIGNED THE EXCLUSIVE USE.

LINKS
Surveying
LAND DEVELOPMENT CONSULTANTS
P.O. Box 118, WILLETTON, 6955
Telephone (08) 9354 8511
Facsimile (08) 9354 8522
Email: links @ links-surveying.com.au

STRATA COMPANY

THE OWNERS OF MANDURAH TERRACE APARTMENTS STRATA PLAN 17133

GROUND FLOOR

LOT 59.

EXCLUSIVE USE OF BUILDING
and OTHER IMPROVEMENTS.

19

REF LAIRD

DATE 04.04.04

SCALE 1 300

JOB No. 11771/004/DWG77104

LINKS Surveying
P.O. Box 118
WILLETTON 6955

Tel: 9354 8511
Fax: 9354 8522

E-mail: links @ links-surveying.com.au

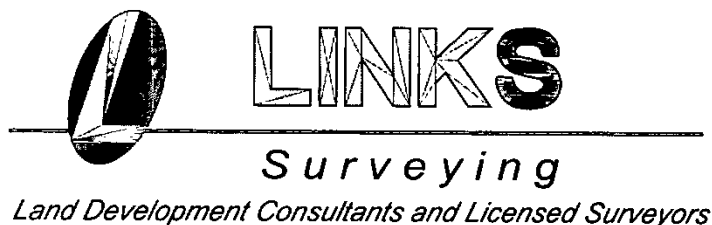

My Ref.: 11771 / 005
Your Ref. : Laird

24th April 2004

Strata Company The Owners of Mandurah Terrace Apartments – Strata Plan 17133.

EXCLUSIVE USE SKETCH 3

LOWER GROUND FLOOR – LOT 59.

Sheet 2 of 2 Sheets.

EXCLUSIVE USE OF BUILDING and OTHER IMPROVEMENTS

Excluding the Perimeter of the Parcel, the angles are multiples of 45 degrees unless stated otherwise.

BOUNDARY DESCRIPTIONS

The boundaries of the exclusive use areas marked 'B59' which are buildings are from the under surface of the lower ground floor concrete slab to the under surface of the ground floor concrete slab and extend to the external surface of the building from the inner surfaces of the walls.

The boundaries of the exclusive use areas marked 'S59' which are stairways are from the under surface of the lower ground floor concrete slab to a height equal to the projection of the top of the balustrade adjacent to the top step or landing.

The boundaries of the exclusive use areas marked 'LGEX59' are from the lowest foundation of the adjacent retaining wall to a height equal to the projection of the under surface of the Lot 59 ground floor concrete slab.

Maintaining Traditional Standards Through People and Technology
STANDFAST NOMINEES Pty Ltd trading as LINKS Surveying. A.B.N. 55 059 735 536

18

EXCLUSIVE USE SKETCH 3
(as per survey)
SHEET 1 OF 2 SHEETS

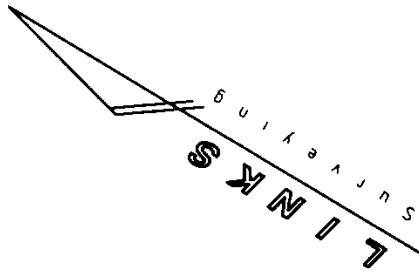
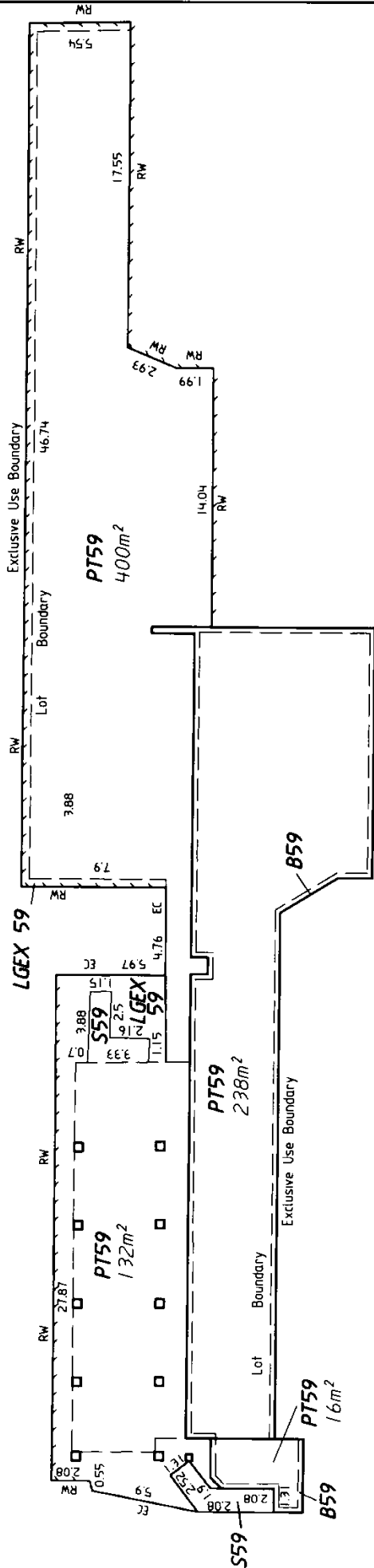

See Sheet 2 of 2 sheets
for Boundary Descriptions.

LINKS
S U R V E Y I N G
LAND DEVELOPMENT CONSULTANTS
P.O. Box 118, WILLETTON, 6955
Telephone (08) 9354 8511
Facsimile (08) 9354 8522
Email links@links-surveying.com.au

STRATA COMPANY THE OWNERS OF MANDURAH TERRACE APARTMENTS STRATA PLAN 17133	
LOWER GROUND FLOOR LOT 59.	EXCLUSIVE USE OF BUILDING and OTHER IMPROVEMENTS.
	NUMBERS INDICATE THE NUMBER OF THE LOT TO WHICH IS ASSIGNED THE EXCLUSIVE USE.
REF LAIRD	DATE 04.04.04
	SCALE 1 300
	JOB No. 11771/004/DWG77104
KEY	<ul style="list-style-type: none"> EX - EXCLUSIVE USE PT - PART LOT EC - EDGE OF CONCRETE RW - RETAINING WALL S - STAIRS B - BUILDING

LINKS Surveying
P.O. Box 118
WILLETTON 6955

Tel: 9354 8511
Fax: 9354 8522

E-mail: links @ links-surveying.com.au



My Ref.: 11771 / 005
Your Ref. : Laird

24th April 2004

Strata Company The Owners of Mandurah Terrace Apartments – Strata Plan 17133.

EXCLUSIVE USE SKETCH 2

GROUND FLOOR – LOTS 21 to 58.

Sheet 2 of 2 Sheets.

**EXCLUSIVE USE OF COMMON PROPERTY
and COMMON PROPERTY PARKING.**

Excluding the Perimeter of the Parcel, the angles are multiples of 45 degrees unless stated otherwise.

BOUNDARY DESCRIPTIONS

The boundaries of the exclusive use areas marked 'CB21-CB58' are from the upper surface of car park to a height of 2.5 metres or where covered to the underside of that cover.

Maintaining Traditional Standards Through People and Technology
STANFAST NOMINEES Pty Ltd trading as LINKS Surveying. A.B.N. 55 059 735 536

16.

EXCLUSIVE USE SKETCH 2
(AS PER SURVEY)

SHEET 1 OF 2 SHEETS

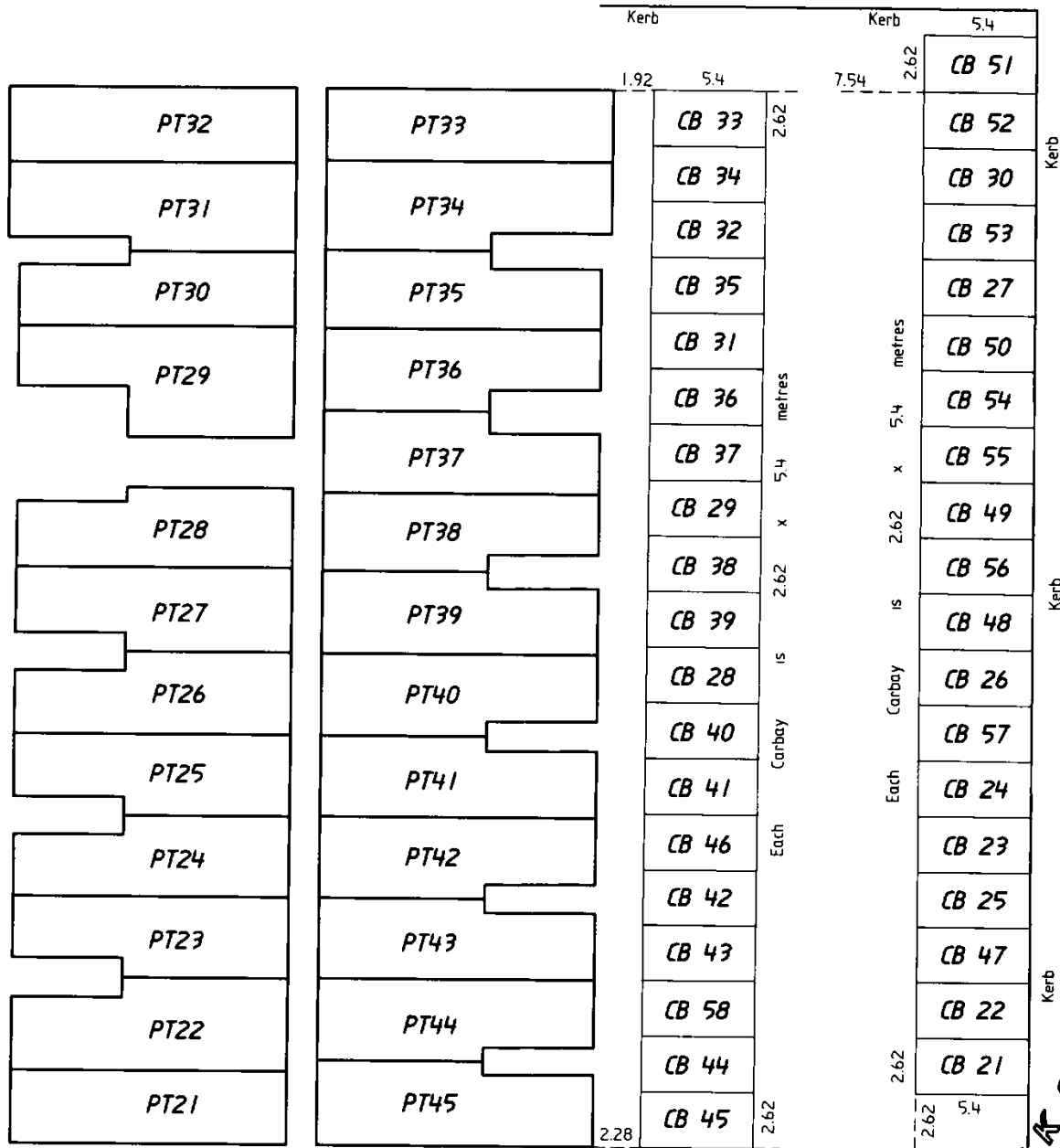

See Sheet 2 of 2 sheets
for Boundary Descriptions.

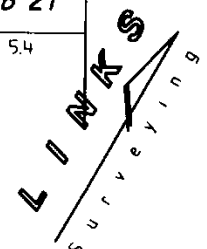
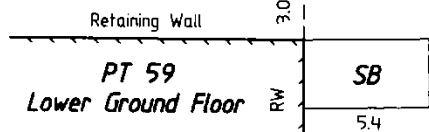

KEY

- P T - PART LOT
- S B - SERVICE BAY
- K - CONCRETE KERB
- C B - CARBAY
- R W - RETAINING WALL
- NUMBER OF THE LOT TO WHICH IS ASSIGNED THE EXCLUSIVE USE.

LINKS
Surveying
LAND DEVELOPMENT CONSULTANTS
P.O. Box 118, WILLETTON, 6955
Telephone (08) 9354 8511
Facsimile (08) 9354 8522
Email links @ links-surveying.com.au

STRATA COMPANY THE OWNERS OF MANDURAH TERRACE APARTMENTS STRATA PLAN 17133

GROUND FLOOR

LOTS 21 - 58.

**EXCLUSIVE USE OF COMMON PROPERTY
and COMMON PROPERTY PARKING.**

15

REF LAIRD DATE 23.04.04 SCALE 1 300 JOB No. 11771/005/DWG77104

LINKS Surveying
P.O. Box 118
WILLETTON 6955

Tel: 9354 8511
Fax: 9354 8522

E-mail: links @ links-surveying.com.au

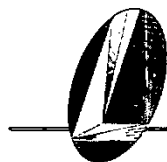

LINKS

Surveying

Land Development Consultants and Licensed Surveyors

My Ref.: 11771 / 005
Your Ref.: Laird

24th April 2004

Strata Company The Owners of Mandurah Terrace Apartments – Strata Plan 17133.

EXCLUSIVE USE SKETCH 1

GROUND FLOOR – LOTS 1 to 20.

Sheet 2 of 2 Sheets.

**EXCLUSIVE USE OF COMMON PROPERTY
and COMMON PROPERTY PARKING.**

Excluding the Perimeter of the Parcel, the angles are multiples of 45 degrees unless stated otherwise.

BOUNDARY DESCRIPTIONS

The boundaries of the exclusive use areas marked 'CB1-CB20' are from the upper surface of car park to a height of 2.5 metres or where covered, to the underside of that cover.

Maintaining Traditional Standards Through People and Technology
STANFAST NOMINEES Pty Ltd trading as LINKS Surveying. A.B.N. 55 059 735 536

14

EXCLUSIVE USE SKETCH 1

(AS PER SURVEY)

SHEET 1 OF 2 SHEETS

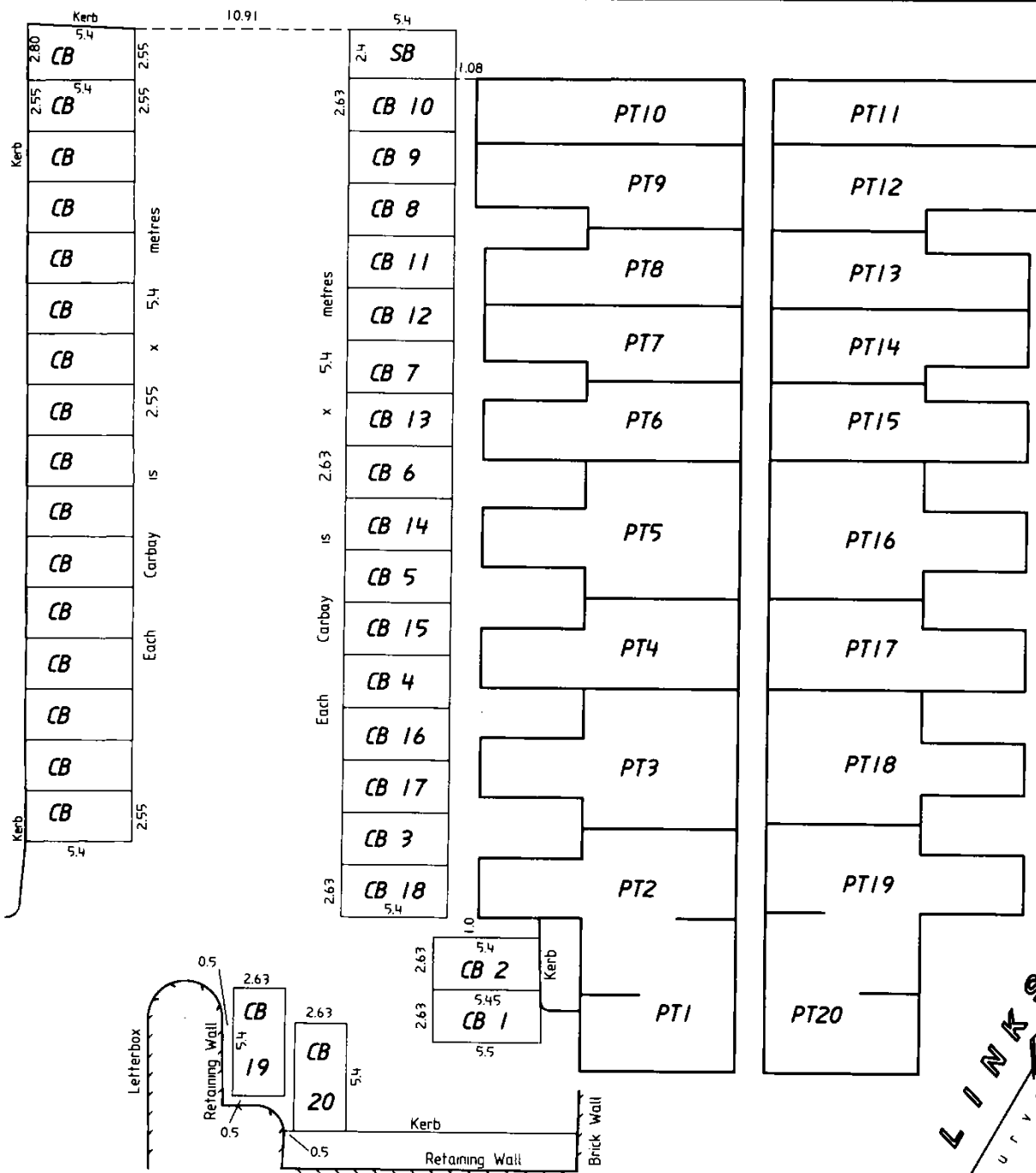

LINKS
Surveying

See Sheet 2 of 2 sheets
for Boundary Descriptions.

KEY

- P T - PART LOT
- S B - SERVICE BAY
- K - CONCRETE KERB
- C B - CARBAY
- R W - RETAINING WALL

NUMBERS INDICATE THE
NUMBER OF THE LOT TO
WHICH IS ASSIGNED THE
EXCLUSIVE USE.

LINKS

Surveying
LAND DEVELOPMENT CONSULTANTS
P.O. Box 118, WILLETTON, 6955
Telephone (08) 9354 8511
Facsimile (08) 9354 8522
Email links @ links-surveying.com.au

STRATA COMPANY

THE OWNERS OF MANDURAH TERRACE APARTMENTS STRATA PLAN 17133

GROUND FLOOR

LOTS 1 - 20.

EXCLUSIVE USE OF COMMON PROPERTY
and COMMON PROPERTY PARKING.

13

REF LAIRD

DATE 23.04.04

SCALE 1 300

JOB No. 11771/005/DWG77104

EXCLUSIVE USE LOCATION PLAN
(AS PER SURVEY)

Perimeter of Parcel

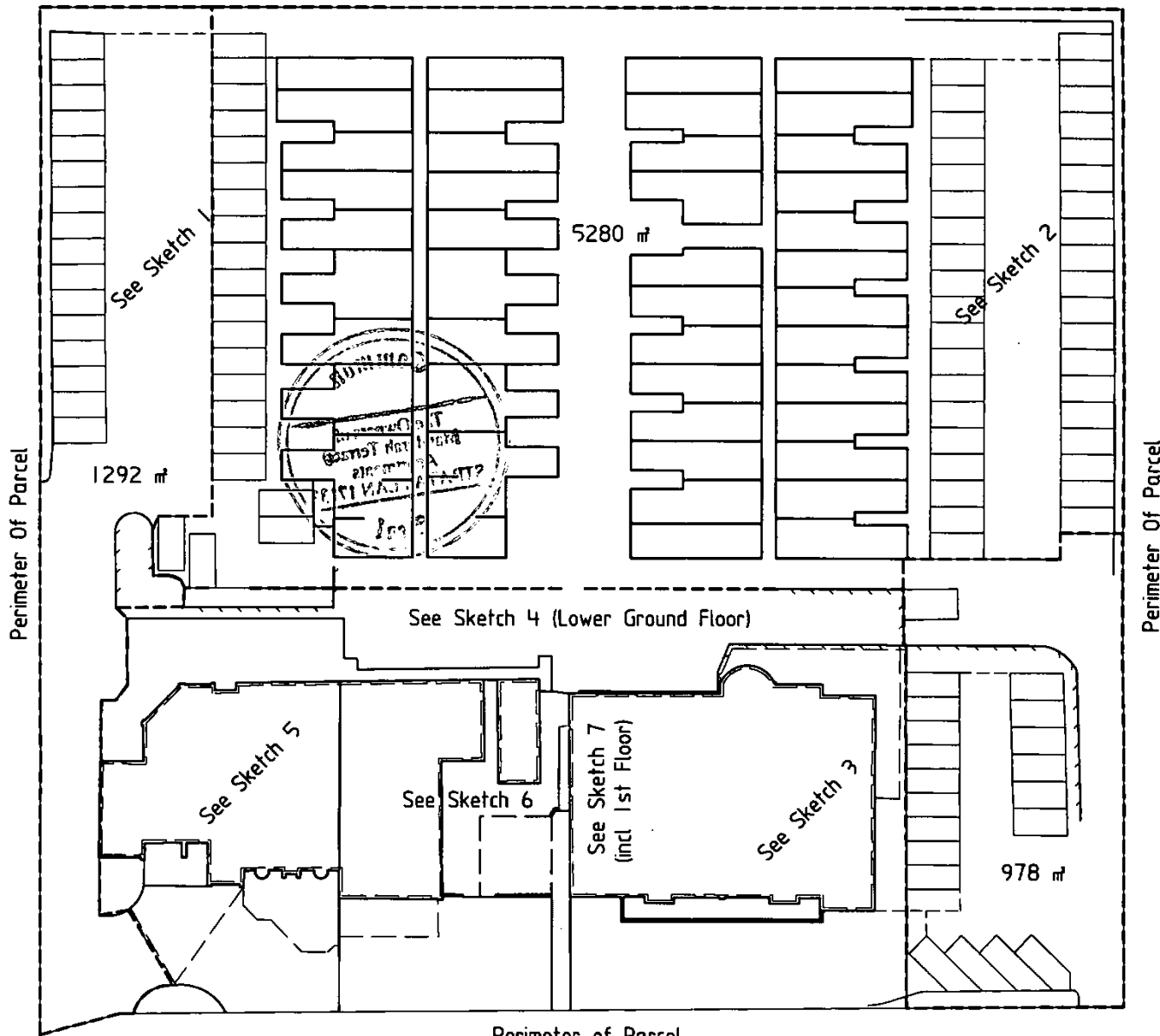

Perimeter of Parcel

MANDURAH TERRACE

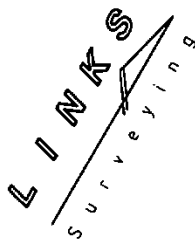

LINKS
Surveying
LAND DEVELOPMENT CONSULTANTS
P.O. Box 118, WILLETTON, 6955
Telephone (08) 9354 8511
Facsimile (08) 9354 8522
Email. links @ links-surveying.com.au

STRATA COMPANY

THE OWNERS OF MANDURAH TERRACE APARTMENTS STRATA PLAN 17133

LOCATION PLAN

For Sketches 1 to 7 inclusive.
Areas for assignment of care.

**EXCLUSIVE USE OF COMMON PROPERTY,
BUILDING, OTHER IMPROVEMENTS
and COMMON PROPERTY PARKING.**

12

REF LAIRD

DATE 10.05.04

SCALE 1 : 600

JOB No. 11771/005/DWG77104

By-law 17. Penalty for breach of by-laws

Any proprietor who breaches any Schedule 1 or 2 by-law is, subject to section 42A(2) of the Act, liable to pay a penalty of \$400.

The common seal of The Owners of Mandurah Terrace Apartments Strata Plan 17133 was hereunto affixed on.....30 Dec '04.....in the presence of-

[Handwritten signature]
.....
Luisa Tate
.....

Members of the Council



(specifically, the strata company's obligation to pay the costs of the parties engaged to assist in the preparation for and involvement in the legal proceedings); and

(g) raise the amount of the extra costs so determined by levying a contribution for that amount pursuant to section 36(1) solely on the proprietor who was unsuccessful in those legal proceedings.

(2) For the purposes of this by-law, "legal proceedings" includes (but is not limited to):

(a) an application to the Strata Titles Referee or State Administrative Tribunal;

(b) the issuing of a notice alleging a breach of the Act or by-laws that could lead to an application to the Strata Titles Referee, State Administrative Tribunal or proceedings in any Court or tribunal;

(c) an appeal from an order of the Strata Titles Referee to the District Court;

(d) an appeal to the Supreme Court from an order of the State Administrative Tribunal; and

(e) any other proceedings in any court or tribunal.

(3) For the purposes of this by-law, "costs" includes (but is not limited to):

(a) strata manager's costs;

(b) debt recovery agent's costs;

(c) costs of any employees of and contractors to the strata company preparing for or being involved in the legal proceedings;

(d) costs of any consultants and experts; and

(e) legal costs and disbursements on a solicitor/own-client indemnity basis.

(4) This by-law takes effect subject to sections 81(11) and 111 of the Act.

By-law 16. Antennae

No television, radio, or other electronic antenna, receiver, encoder, transmitter or device of any similar type shall be erected, constructed, placed or permitted to remain on the common property unless it has been approved in writing by the council of the strata company.

By-law 7. Signage and laundry

(1) A proprietor, occupier, or other resident of lots 1 to 58 shall not, except with the prior written consent of the council of the strata company:

(a) hang any washing, towel, bedding, clothing or other article on any part of the parcel in such a way as to be visible from another lot or the common property, other than for a reasonable period on any lines provided by the strata company for the purpose; or

(b) display any sign, advertisement, placard, banner, pamphlet or like matter on any part of his lot or the common property in such a way as to be visible from another lot or the common property.

(2) Notwithstanding any other by-law, a proprietor or occupier of lots 59 to 62 may affix or display any sign, advertisement, placard, banner or like matter relating to the business of the proprietor or occupier on any part of his lot or on the external vertical surface of the common property buildings immediately adjacent to his lot, provided that any such sign, advertisement, placard, banner or like matter complies with the local government requirements and is within the boundary of an exclusive use and enjoyment area. The council of the strata company will, within 21 days of a written request to do so, endorse any necessary application to the local government that will give effect to the terms of this sub-by-law.

By-law 15. Recovery of costs of legal proceedings

(1) If:

(a) a proprietor starts legal proceedings against the strata company or legal proceedings in which the strata company becomes involved; or

(b) the strata company starts legal proceedings against a proprietor or legal proceedings in which a proprietor becomes involved as a party with an adverse interest;
and:

(c) that proprietor is not successful in those legal proceedings; and

(d) the strata company incurs costs in preparing for, being a party in or being involved in those legal proceedings; and

(e) some or all of those costs are not recoverable in those legal proceedings ("the extra costs");

then the council of the strata company is empowered to:

(f) determine that the extra costs shall be included in the amounts to be raised for the purposes set out in section 36(1)(a) of the Act

And,

That by Special Resolution duly passed at a meeting of the Strata Company on 28 November 2004 and which became unconditional on 29 December 2004 the **by-laws in Schedule 2** to the Act as they applied to the Strata Company were amended by:

- repealing by-laws numbered 1, 3, 7; and
- adding the following by-laws numbered 1, 3, 7, 15, 16 and 17.

By-law 1. Use of car bays

Notwithstanding any other by-law, a proprietor, occupier or other resident shall ensure that:

- (a) any vehicle parked, stored or kept on any car bay (whether subject to an exclusive use and enjoyment grant or otherwise) is wholly within the marked boundary of that car bay;
- (b) no boat, trailer, caravan, unlicensed or un-roadworthy vehicle is parked, kept or stored on any lot or the common property without the prior written consent of the council of the strata company, which consent may be withdrawn at any time;
- (c) visitors park only within any common property areas designated for that purpose and for a reasonable time period not to exceed twenty-four continuous hours;
- (d) oil, grease or flammable material caused or contributed towards by any vehicle stood or parked on his lot or the common property visitor parking areas is removed as soon as he is aware of the same;
- (e) no vehicle is driven at more than 10kmh while on common property; and
- (f) no vehicle is serviced or has any other mechanical work performed on it whilst on a lot or common property other than as may be required to remove the vehicle from the parcel.

By-law 3. Damage to common property

A proprietor, occupier or other resident shall not damage any portion of the common property or, except with the prior written consent of the council of the strata company, plant, remove or damage any plant, tree, shrub, flower, lawn or garden upon the common property.

(4) For the avoidance of doubt, the proprietors of all lots shall bear all other expenses of discharging the obligations of the strata company, subject to section 47, in proportion to the unit entitlements of their respective lots. These expenses shall include but not be limited to:

Group C expenses – lots 1 to 62.

(a) Costs of the strata company incurred in respect to repair, maintenance, renewal or replacement of the common property, including gardens, grounds, stormwater disposal system in driveways and rear car park areas, security gates, car park and open area common property, but not including common property contained within the area designated as "Mutual Residential Cost Responsibility Area" on the annexed sketch marked Mutual Residential Cost Responsibility or the subject of a grant of exclusive use and enjoyment;

(b) 30% of the amount charged to the strata company by utility providers for or in respect of power and water supplied;

(c) Costs associated with the administration of the affairs of the strata company including strata manager's fees, usual stationery, postage, petty and bank charges, conduct of council and general meetings and professional fees (such as engineers, valuers, legal and other consultants); and,

(d) Caretaker and security costs.

(5) The strata company shall account to, determine the funding required in respect of and levy contributions separately upon each of the three groups of proprietors (the proprietors of lots 59 to 62, the proprietors of lots 1 to 58 and the proprietors of all lots). This shall be done by adopting a separate budget, statement of expenditure and funding proposal in respect of each of the groups of expenses referred to at sub-by-laws 2 to 4 above.

By-law 21. Reimbursement of insurance claim excess

If the strata company is required to pay an excess as a result of a claim arising out of any act or omission of a proprietor, occupier or invitee of a proprietor or occupier of a lot, that excess shall be payable by the proprietor of that lot and may be recovered by the strata company from that proprietor as if it were a contribution levied pursuant to Section 36(1) of the Act.

By-law 22. Restriction of contributions to a reserve fund

Any reserve fund established pursuant to section 36(2) of the Act shall be restricted to accumulating funds for contingent expenses likely to arise in the future only in respect to major repair of common property excluding any part of common property within the area designated as "Mutual Residential Cost Responsibility Area" on the annexed sketch marked Mutual Residential Cost Responsibility or the subject of a grant of exclusive use and enjoyment.

By-law 19. Commercial use of lots 59 to 62

The proprietors or occupiers of lots 59 to 62 shall be entitled to use their lots for any commercial purpose which is permitted under the current Town Planning Scheme of the local government, including such commercial use as may be within the approval discretion of the local government. The council of the strata company will, within 21 days of a written request to do so, endorse any necessary application to the local government that will give effect to the terms of this by-law.

By-law 20. Different basis for levying contributions

(1) Pursuant to section 42B, contributions will not in every case be levied on proprietors in proportion to the unit entitlement of their respective lots, but will be levied according to sub-by laws (2) to (5) below.

(2) The proprietors of lots 59 to 62 shall bear the cost of the expenses below in the proportion that their unit entitlement of their respective lots bears to the aggregate unit entitlement of lots 59 to 62:

Group A expenses – lots 59 to 62.

The differential, added cost of insurance premium for commercial as distinct from residential use of lots 59 to 62, as evidenced by indicative premium quotations provided by the strata company insurer.

(3) The proprietors of lots 1 to 58 shall bear the cost of the expenses below in the proportion that their unit entitlement of their respective lots bears to the aggregate unit entitlement of lots 1 to 58:

Group B expenses – lots 1 to 58.

(a) Costs of the strata company incurred in respect to repair, maintenance, renewal or replacement of the common property contained within the area designated as "Mutual Residential Cost Responsibility Area" on the annexed sketch marked Mutual Residential Cost Responsibility;

(b) Provision of hot water supply to lots 1 to 58;

(c) Principal and interest payable against the bank loan in the name of the strata company as at the date of the making of this by-law;

(d) The differential, lesser cost of insurance premium for residential as distinct from commercial use, of lots 1 to 58, as evidenced by indicative premium quotations provided by the strata company insurer; and

(e) 70% of the amount charged to the strata company by utility providers for or in respect of power and water supplied.

- (3) The proprietors of lots 61 and 62 shall have the exclusive use and enjoyment of that part of the common property located immediately adjacent to their respective lot ("Exclusive Use Area") shown on the annexed "Exclusive Use Sketches" numbered 6 and 7 and marked "B#", "GA#", "GEX#", "LGEX#", "S#" & "PC#" (where # represents the number of that proprietor's lot) subject to, in respect of each of the proprietors, compliance with sub-bylaw (4).
- (4) Each proprietor granted exclusive use and enjoyment of an Exclusive Use Area by sub-bylaw 3 shall:
- (a) not alter, modify, erect, demolish or add to the Original Common Property Buildings and Improvements or the Permitted Additional Common Property Improvements without the written approval of the council of the strata company;
 - (b) keep any part of the Exclusive Use Area that is visible from any part of the parcel free from dirt, corrosion, unsightly marks or objects;
 - (c) ensure that the use of the Exclusive Use Area does not affect the quiet and peaceful enjoyment of any other lot or the common property; and
 - (d) allow the strata company by its agents, employees, councillors and contractors to enter upon the lot, the Exclusive Use Area and immediately adjacent common property to inspect and carry out works on the common property (including the Exclusive Use Area), after giving reasonable notice;
 - (e) at their own cost, keep in good and serviceable repair, properly maintain and, where necessary, renew and replace the Exclusive Use Area and do so whether damage or deterioration arises from fair wear and tear, inherent defect or any other cause. If a proprietor fails to do so, after giving that proprietor reasonable notice, the strata company may arrange and carry out all works required. The proprietor agrees that the costs of any such works may be recovered from that proprietor as if such costs were a contribution levied pursuant to section 36(1) of the Act; and
 - (f) indemnify the strata company against all actions, claims, demands, suits or causes of action arising out of any wilful or negligent act or omission or breach of duty of care in respect of the Exclusive Use Area; and
 - (g) obtain and ensure that all occupiers obtain comprehensive insurance to adequately cover all actions, claims, demands, suits or causes of action referred to in sub-by law 4(f) and upon demand by the strata company produce evidence that such insurance has been obtained and is current."

may arrange and carry out all works required. The proprietor agrees that the costs of any such works may be recovered from that proprietor as if such costs were a contribution levied pursuant to section 36(1) of the Act; and

(f) indemnify the strata company against all actions, claims, demands, suits or causes of action arising out of any wilful or negligent act or omission or breach of duty of care in respect of the Exclusive Use Area; and

(g) obtain and ensure that all occupiers obtain comprehensive insurance to adequately cover all actions, claims, demands, suits or causes of action referred to in sub-by law 4(f) and upon demand by the strata company produce evidence that such insurance has been obtained and is current.

By-law 18. Exclusive use of common property by lots 61 and 62.

(1) In this by-law:

“Exclusive Use Area” means that part of the common property that is referred to in sub-by-law (3), including the Original Common Property Buildings and Improvements and the Permitted Additional Common Property Improvements;

“Original Common Property Buildings and Improvements” means those improvements that formed part of the common property, and being within the Exclusive Use Area, at the time of registration of the strata plan and specifically the original buildings, paving, gardens, stairs, retaining walls, balustrading, fences, light fixtures, support posts, air conditioning system components, ceramic floor and wall tiling, roof cover and any fixtures and fittings thereto; and

“Permitted Additional Common Property Improvements” means the existing or future improvements (including signage, communications and security equipment) to common property excluding the Original Common Property Buildings and Improvements and specifically those improvements agreed to in writing by the council of the strata company.

(2) The proprietors of lots 61 and 62 shall have the right to install and keep the Original Common Property Buildings and Improvements and the Permitted Additional Common Property Improvements upon the common property within the Exclusive Use Area immediately adjacent to that proprietor’s lot on the condition that the installation of the Permitted Common Property Improvements is at that proprietor’s own cost and subject to, in respect of each of the proprietors, compliance with sub-by-law (4).

“Permitted Additional Common Property Improvements” means the existing or future improvements (including signage, communications and security equipment) to common property excluding the Original Common Property Buildings and Improvements and specifically those improvements agreed to in writing by the council of the strata company.

- (2) The proprietors of lots 59 and 60 shall have the right to install and keep the Original Common Property Buildings and Improvements and the Permitted Additional Common Property Improvements upon the common property within the Exclusive Use Area immediately adjacent to that proprietor’s lot on the condition that the installation of the Permitted Common Property Improvements is at that proprietor’s own cost and subject to, in respect of each of the proprietors, compliance with sub-bylaw (4).
- (3) The proprietors of lots 59 and 60 shall have the exclusive use and enjoyment of that part of the common property located immediately adjacent to their respective lot (“Exclusive Use Area”) shown on the annexed “Exclusive Use Sketches” numbered 3, 4, and 5 and marked “B#”, “GA#”, “GEX#”, “LGEX#”, “S#” & “PC#” (where # represents the number of that proprietor’s lot) subject to, in respect of each of the proprietors, compliance with sub-bylaw (4).
- (4) Each proprietor granted exclusive use and enjoyment of an Exclusive Use Area by sub-bylaw 3 shall:
 - (a) not alter, modify, erect, demolish or add to the Original Common Property Buildings and Improvements or the Permitted Additional Common Property Improvements without the written approval of the council of the strata company;
 - (b) keep any part of the Exclusive Use Area that is visible from any part of the parcel free from dirt, corrosion, unsightly marks or objects;
 - (c) ensure that the use of the Exclusive Use Area does not affect the quiet and peaceful enjoyment of any other lot or the common property; and
 - (d) allow the strata company by its agents, employees, councillors and contractors to enter upon the lot, the Exclusive Use Area and immediately adjacent common property to inspect and carry out works on the common property (including the Exclusive Use Area), after giving reasonable notice;
 - (e) at their own cost, keep in good and serviceable repair, properly maintain and, where necessary, renew and replace the Exclusive Use Area and do so whether damage or deterioration arises from fair wear and tear, inherent defect or any other cause. If a proprietor fails to do so, after giving that proprietor reasonable notice, the strata company

(c) no goods are stored or kept in the Car-Parking Bay without the prior written consent of the council of the strata company, which consent may be withdrawn at any time;

(d) no vehicle is serviced or has any mechanical work performed on it within the Car-Parking Bay other than as may be necessary to start or remove it from the parcel;

(e) no oil, grease or flammable material accumulates within the Car-Parking Bay; and

(f) the strata company by its agents, employees, councillors and contractors is allowed to enter upon the Car-Parking Bay and immediately adjacent common property to inspect and carry out works on the common property (including the Car-Parking Bay), after giving reasonable notice.

(3) Each proprietor and occupier granted exclusive use and enjoyment of a Car-Parking Bay by sub-by-law 1 shall:

(a) at their own cost, keep in good and serviceable repair, properly maintain and, where necessary, renew and replace the Car-Parking Bay and do so whether damage or deterioration arises from fair wear and tear, inherent defect or any other cause. If a proprietor fails to do so, after giving that proprietor reasonable notice, the strata company may arrange and carry out all works required. The proprietor agrees that the costs of any such works may be recovered from that proprietor as if such costs were a contribution levied pursuant to section 36(1) of the Act; and

(b) indemnify the strata company against all actions, claims, demands, suits or causes of action arising out of any wilful or negligent act or omission or breach of duty of care in respect of the Car-Parking Bay.

By-law 17. Exclusive use of common property by lots 59 and 60.

(1) In this by-law:

“Exclusive Use Area” means that part of the common property that is referred to in sub-by-law (3), including the Original Common Property Buildings and Improvements and the Permitted Additional Common Property Improvements;

“Original Common Property Buildings and Improvements” means those improvements that formed part of the common property, and being within the Exclusive Use Area, at the time of registration of the strata plan and specifically the original buildings, paving, gardens, stairs, retaining walls, balustrading, fences, light fixtures, support posts, air conditioning system components, ceramic floor and wall tiling, roof cover and any fixtures and fittings thereto; and

BLANK INSTRUMENT FORM

NOTIFICATION

(Note 1)

FORM 21

NOTIFICATION OF CHANGE OF BY-LAWS
STRATA TITLES ACT 1985
SECTION 42

The Owners of Mandurah Terrace Apartments Strata Plan 17133 hereby certifies that by Resolution Without Dissent duly passed at a meeting of the Strata Company on 28 November 2004 and which became unconditional on 29 December 2004, the **by-laws in Schedule 1** to the Act as they applied to the Strata Company were amended by:

- repealing Part 1 by-law 16 and those by-laws numbered 17 to 36 inclusive registered on the strata plan by notifications F106181, F937504, G91790, G403460 and G703970; and
- adding the following by-laws in their place numbered 16 to 22:

By-law 16. Exclusive use of common property car parking bays by lots 1-58.

- (1) The proprietors of lots **1 to 30, 33, 34, 36 to 50 and 52 to 58** shall have the exclusive use and enjoyment of that part of the common property being a car-parking bay ("the Car-Parking Bay") bearing the same number as their respective lots, preceded by "CB" shown on the annexed "Exclusive Use Sketches" numbered 1 and 2 for the purpose of parking a vehicle, subject to, in respect of each of the proprietors, compliance with sub-bylaws (2) and (3).
- (2) Each proprietor and occupier granted exclusive use and enjoyment of a Car-Parking Bay by sub-bylaw 1 shall ensure that:
 - (a) any vehicle is at all times parked, stored or kept wholly within the vertical and horizontal boundaries of the Car-Parking Bay and does not obstruct the use of any lot or other part of the common property;
 - (b) no boat, trailer, caravan, unlicensed or un-roadworthy vehicle is parked, stored or kept in the Car-Parking Bay without the prior written consent of the council of the strata company, which consent may be withdrawn at any time;

INSTRUCTIONS

1. This form may be used only when a "Box Type" form is not provided or is unsuitable. It may be completed in narrative style.
2. If insufficient space hereon Additional Sheet Form B1 should be used.
3. Additional Sheets shall be numbered consecutively and bound to this document by staples along the left margin prior to execution by the parties.
4. No alteration should be made by erasure. The words rejected should be scored through and those substituted typed or written above them, the alteration being initialled by the persons signing this document and their witnesses.

NOTES

1. Insert document type.
2. A separate attestation is required for every person signing this document. Each signature should be separately witnessed by an Adult Person. The address and occupation of the witness must be stated.

K827821 AE

16 Jan 2009 14:08:05 Perth



REG \$ 88.00

LODGED BY

SHEILA JACKSON

ADDRESS

P O Box 982
MANDURAH

PHONE No.

NA 6210
0428371944

FAX No.

PHONE OR 95371315

REFERENCE No.

ISSUING BOX No.

999L

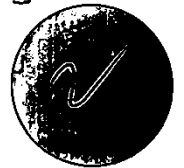

PREPARED BY

IAN LAIRD

ADDRESS

P.O. Box 139
FREMANTLE

PHONE No.

9430 4468

FAX No.

9430 9951

INSTRUCT IF ANY DOCUMENTS ARE TO ISSUE TO OTHER THAN LODGING PARTY

TITLES, LEASES, DECLARATIONS ETC LODGED HEREWITH

1. _____
2. _____
3. _____
4. _____
5. _____
6. _____

Received Items

Nos. 0

Receiving Clerk

Registered pursuant to the provisions of the TRANSFER OF LAND ACT 1893 as amended on the day and time shown above and particulars entered in the Register.

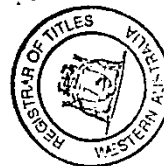

EXAMINED

- (i) use the proprietors best endeavours to ensure that the occupier duly and punctually remedies the breach; and
- (ii) if the breach is sufficient to justify the issue of a default notice under any lease or tenancy agreement in respect of the lot, the proprietor shall take immediate steps to enforce all rights available to the proprietor to have the breach remedied and if not remedied within the time specified in the lease or tenancy agreement or, in any other case, within a reasonable time specified, to give and pursue notice of termination which the proprietor is entitled to give under the lease or tenancy agreement.

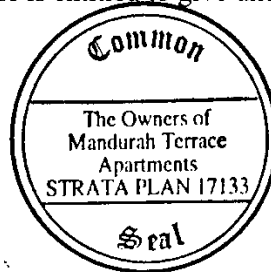

The common seal of The Owners of Mandurah Terrace Apartments Strata Plan 17133 was hereunto affixed on...14TH JANUARY 2009...in the presence of-

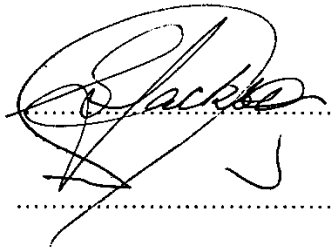
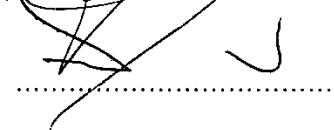
 SHEILA JACKSON
 TRACEY FORD

Members of the Council

That by Special Resolution duly passed at a meeting of the Strata Company on 19 October 2008 and which became unconditional on 17 November 2008 the **by-laws in Schedule 2** to the Act as they applied to the Strata Company were amended by:

- adding the following by-laws numbered 18 and 19.

By-law 18. Restrictions on Parking on Common Property.

1. A proprietor or occupier of a lot shall not, and shall ensure that any visitor of that proprietor or occupier shall not, park or stand any vehicle or object on any part of the common property that is not the subject of an exclusive use or special privileges by-law granted by the strata company in relation to that lot.

By-law 19. Details of Transferees, Lessees and Tenants and Related Obligations.

1. A proprietor who has entered into a contract to transfer his lot shall, not less than 14 days before registration of the transfer of the lot, advise the Strata Company in writing;
 - (i) the name and address of the person whom the proprietors lot is to be transferred; and
 - (ii) the mailing address of the proprietor after the transfer of the lot, and
2. A proprietor who proposes to grant any lease or tenancy rights in respect of his lot shall, not less than 14 days before allowing the lessee or tenant to occupy his lot:
 - (i) advise the Strata Company in writing the name and address of the lessee or tenant, the commencement date of the lease or tenancy and the period for which the lease or tenancy is to be granted; and
 - (ii) confirmation in writing that the lessee or tenant has been duly processed and confirmed through the Tenancy Data Base; and
 - (iii) obtain and provide to the Strata Company an acknowledgement by the lessee or tenant of receipt of a copy of the Strata Company by-laws;
3. Unless a lease or tenancy agreement in respect of a lot includes a covenant by the lessee or tenant to be bound by the by-laws of the Strata Company to the extent that they apply to the use and enjoyment of the lot and the common property by the lessee or tenant, the proprietor shall, before allowing the lessee or tenant to occupy the lot, obtain and provide to the Strata Company an acknowledgement in writing from the lessee or tenant agreeing to be bound by a covenant to that effect, including an acknowledgement that there is only one common property car bay available for use in relation to the lot.
4. If, while the proprietor's lot is occupied by a person other than the proprietor, the Strata Company gives notice to the proprietor of any un-remedied breach by the occupier of any of the by-laws, the proprietor shall:

BLANK INSTRUMENT FORM

┌
┌
┌

┐
┐
┐

NOTIFICATION

(Note 1)

FORM 21

**NOTIFICATION OF CHANGE OF BY-LAWS
STRATA TITLES ACT 1985
SECTION 42**

The Owners of Mandurah Terrace Apartments Strata Plan 17133 hereby certifies that by Resolution Without Dissent duly passed at a meeting of the Strata Company on 19 October 2008 and which became unconditional on 17 November 2008, the **by-laws in Schedule 1** to the Act as they applied to the Strata Company were amended by:

- adding the following by-law:

By-law 23. Exclusive use of common property rights for screen doors by lots 1 - 45

1. Subject to sub by-law (2), each proprietor is entitled to remove the rear bedroom screen door of his respective lot from inside the glass door of the lot and to relocate it on the common property in a position outside of the glass door in accordance with and subject to compliance with plans and specifications to be provided by the strata company.
2. For the purpose of this by-law the strata company grants to the proprietor of any lot who effects such removal and relocation the right of exclusive use and enjoyment, for that purpose only, the part of the common property to be occupied by the relocated screen door and its frame subject to the proprietor;
 - (a) not making any changes to colour, style, materials or design of the relocated screen door and frame without the prior written approval of the strata company; and
 - (b) being responsible for the cost of the removal and relocation, and of keeping the relocated screen door and frame in good order, repair and functional condition and properly maintained and, where necessary, replacing the relocated screen door and frame.

And,

┌

┐

M296231 AE

06 Jun 2013 12:11:47 Perth



REG \$ 160.00

LODGED BY SHEILA JACKSON

ADDRESS P.O. Box 982
MANDURRA, W.A. 6210

PHONE No. (08) 9537 1315

FAX No. (08) 9537 1315

REFERENCE No.

ISSUING BOX No. 888V



PREPARED BY IAN LAIRD

ADDRESS P O BOX 139 FREMANTLE 6959

PHONE No. 9430 4468

FAX No. 94309951

INSTRUCT IF ANY DOCUMENTS ARE TO ISSUE TO OTHER THAN LODGING PARTY

(1)

TITLES, LEASES, DECLARATIONS ETC LODGED HERewith

1. _____	Received Items
2. _____	Nos.
3. _____	
4. _____	
5. _____	
6. _____	Receiving Clerk

Registered pursuant to the provisions of the TRANSFER OF LAND ACT 1893 as amended on the day and time shown above and particulars entered in the Register.

EXAMINED

Landgate



NOTIFICATION

FORM 21

**NOTIFICATION OF CHANGE OF BY-LAWS
STRATA TITLES ACT 1985
SECTION 42**

The Owners of Mandurah Terrace Apartments Strata Plan 17133 hereby certifies that by Resolution Without Dissent duly passed at a meeting of the Strata Company on March 24 2013 and which became unconditional on April 22 2013 the by-laws in Schedule 1 to the Act as they applied to the Strata Company were added to as follows:

New Schedule 1 by-law 24

24. Penalty for breach of by-law

Pursuant to Section 42A(1) and subject to section 42A(2) of the Act, the penalty for a breach of any provision of any Schedule 1 by-law or any Schedule 2 by-law shall be \$500.00 or such greater amount as may from time to time be prescribed as the maximum amount for the purposes of section 42A or section 1031.

The common seal of the The Owners of Mandurah Terrace Apartments Strata Plan 17133 was hereunto affixed on... 5TH JUNE 2013 in the presence of-

[Signature].....Signature
Raquel Tempinni.....Print name

[Signature].....Signature
SHEILA JACKSON.....Print name

Members of the Council



OFFICE USE ONLY

0081089 AE

30 Jan 2019 15:08:13 Perth



LODGED BY *SHEILA JACKSON*

ADDRESS *P.O. Box 982
MANDURAH WA 6210*

PHONE No. *0428371944*

FAX No. *(08) 95371315*

REFERENCE No.

ISSUING BOX No. *888U*

PREPARED BY *Ian Laird*

ADDRESS *P O Box 139, Fremantle, 6959*

PHONE No. *9430 4468*

FAX No. *9430 9951*

INSTRUCT IF ANY DOCUMENTS ARE TO ISSUE TO OTHER THAN LODGING PARTY

14

TITLES, LEASES, DECLARATIONS ETC LODGED HERewith

1. _____	Received Items
2. _____	Nos.
3. _____	
4. _____	
5. _____	Receiving Clerk
6. _____	<i>[Signature]</i>

Registered pursuant to the provisions of the *TRANSFER OF LAND ACT 1893* as amended on the day and time shown above and particulars entered in the Register.

EXAMINED





NOTIFICATION

FORM 21

**NOTIFICATION OF CHANGE OF BY-LAWS
STRATA TITLES ACT 1985
SECTION 42**

The Owners of Mandurah Terrace Apartments Strata Plan 17133 hereby certifies that by Resolution Without Dissent duly passed at a meeting of the Strata Company on 16 December 2018 and which became unconditional on 13 January 2019 the by-laws in Schedule 1 to the Act as they applied to the Strata Company were repealed and added to as follows:

Schedule 1 By-law 12(4) is repealed and the following new Schedule 1 By-law 12(4) is inserted in its place:

12(4) If a quorum is not present within 30 minutes after the time appointed for a general meeting convened upon the requisition of proprietors, that meeting shall be dissolved. If a quorum is not present within 30 minutes after the time appointed for any other general meeting, the persons present and entitled to vote shall constitute a quorum.

New Schedule 1 By-law 24 is added

24. Costs of common property doors and windows

24.1 The strata company shall levy contributions in respect of the costs of repair, maintenance or replacement of common property entry doors, common property balcony doors and common property windows adjoining each lot in accordance with this by-law and not in accordance with unit entitlements.

24.2 Pursuant to section 42B of the Act, the strata company shall levy contributions in respect of the costs of repair, maintenance or replacement of common property entry doors, common property balcony doors and common property windows adjoining each part of a lot on the proprietor of the lot concerned.

The common seal of The Owners of Mandurah Terrace Apartments Strata Plan 17133 was hereunto affixed on 30th JANUARY 2019.in the presence of-

.....Signature
STEWART HETHERINGTON.....Print name

.....Signature
STEWART HETHERINGTON.....Print name

Members of the Council



2 1 4

2 1